

A Wide Variety of Square and Round Sockets in Front-mounting and Back-mounting Models

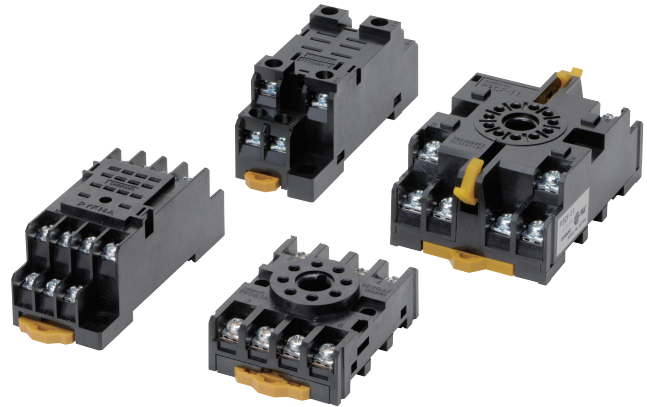



- Models available with finger protection.
- Hold-down Clips and Short Bars for PYFZ/PYF Sockets are also available.
- New screwless models available.

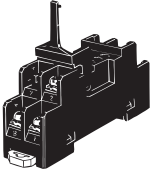

For the most recent information on models that have been certified for safety standards, refer to your OMRON website.

Ordering Information

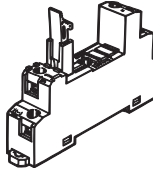
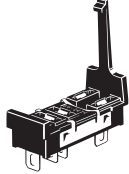
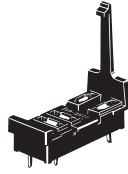
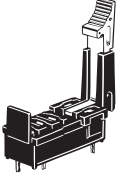
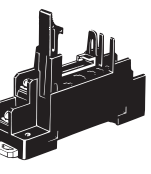
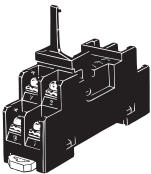

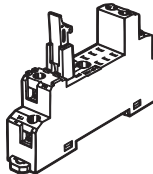
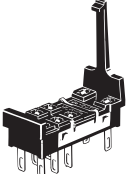
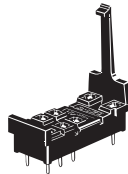
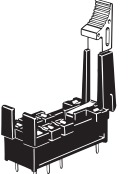









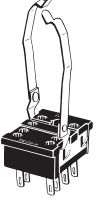
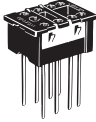
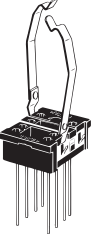



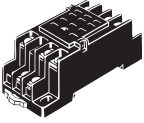

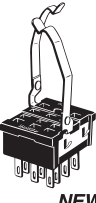
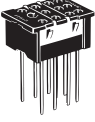
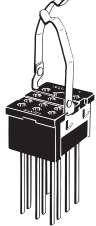
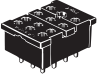
Square Sockets

Model Number of pins	P2RF (front-mounting), page 8			P2R (back-mounting), pages 11 and 12			P7TF (front-mounting), page 12
				Solder terminals	PCB terminals		
5 pins	P2RF-05 Approx. 27 g 	P2RFZ-05-E Approx. 30 g 	P2RF-05-E* Approx. 38 g 	P2R-05A Approx. 5 g 	P2R-05P Approx. 5 g 	P2R-057P Approx. 5.5 g 	P7TF-05 Approx. 28 g 
8 pins	P2RF-08 Approx. 33 g 	P2RFZ-08-E Approx. 38 g 	P2RF-08-E* Approx. 38 g 	P2R-08A Approx. 5 g 	P2R-08P Approx. 5 g 	P2R-087P Approx. 5.5 g 	—

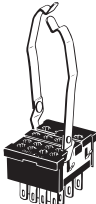
Note: 1. The structure of □-E models provides finger protection. Round terminals cannot be used. Use forked crimp terminals.

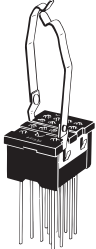
2. To remove the Relay, pull the lever on the Socket with your fingers supporting the lever and the opposite side of the Relay case, and jiggle the Relay.

* Use a #1 Phillips screwdriver to tighten the screws on this Socket.





Model Number of pins	PYF (front-mounting), pages 13 to 14		PY (back-mounting), pages 16 to 14				
			Solder terminals		Wrapping terminals		PCB terminals
8 pins	PYF08A *3 Approx. 32 g	PYF08M Approx. 26 g	PY08 Approx. 8 g	PY08-Y1 PY08-Y3	PY08QN Approx. 12 g PY08QN2	PY08QN-Y1 PY08QN2-Y1	PY08-02 *2 Approx. 7.2 g
							
	PYF08A-E *1,3	PYFZ-08 Approx. 32 g					
		 <i>NEW</i>					
		PYFZ-08-E *3 Approx. 32 g					
		 <i>NEW</i>					
11 pins	PYF11A Approx. 43 g		PY11 Approx. 9 g	PY11-Y1	PY11QN PY11QN2	PY11QN-Y1 PY11QN2-Y1	PY11-02 *2
				 <i>NEW</i>			
14 pins	PYF14A *3 Approx. 49 g	PYFZ-14 Approx. 50 g	PY14 Approx. 10 g	PY14-Y1 PY14-Y3	PY14QN Approx. 14 g PY14QN2	PY14QN-Y1 PY14QN2-Y1 PY14QN-Y3 PY14QN2-Y3	PY14-02 *2
		 <i>NEW</i>					
	PYF14A-E *1,3	PYFZ-14-E *1 Approx. 50 g					
		 <i>NEW</i>					

Note: The structure of □-E models provides finger protection. Round terminals cannot be used. Use forked crimp terminals.

*1. Use a #1 Phillips screwdriver to tighten the screws on this Socket.

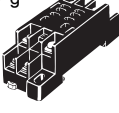
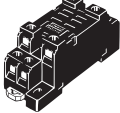
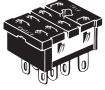
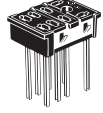
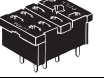
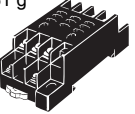
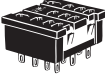
*2. The structure does not resist flux. Manual soldering is recommended for this product.

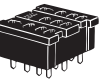
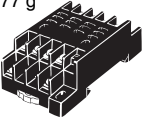
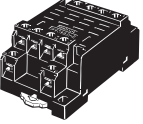
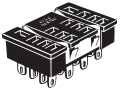
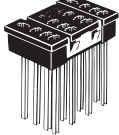
*3. Scheduled to be discontinued in March 2021.

Model Number of pins	PTF (front-mounting), pages 18 to 15		PT (back-mounting), pages 19 to 16		
			Solder terminals	Wrapping terminals	PCB terminals
8 pins	PTF08A Approx. 47 g 	PTF08A-E *1 	PT08 Approx. 11 g 	PT08QN Approx. 10.4 g 	PT08-0 *2 Approx. 8 g 
11 pins	PTF11A Approx. 61 g 		PT11 Approx. 13 g 	PT11QN 	PT11-0 *2 Approx. 12.2 g 
14 pins	PTF14A Approx. 77 g 	PTF14A-E *1 	PT14 Approx. 17 g 	PT14QN Approx. 20 g 	PT14-0 *2 Approx. 16.2 g 

Note: The structure of □-E models provides finger protection. Round terminals cannot be used. Use forked crimp terminals.





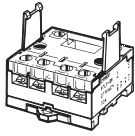





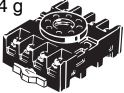

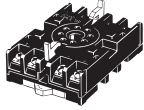
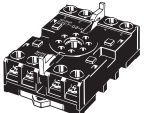
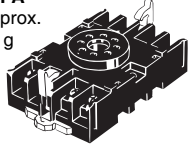
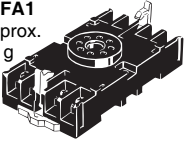
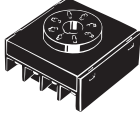

* Use a #1 Phillips screwdriver to tighten the screws on this Socket.

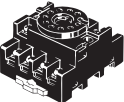
* The structure does not resist flux. Manual soldering is recommended for this product.

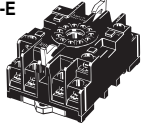
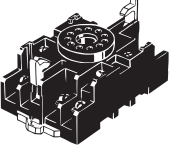
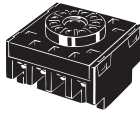
Model Number of pins	P7LF (front-mounting), page 20
6 pins	P7LF-06 Approx. 60 g 

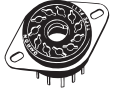
Note: Refer to *Models with Standards Certification* for detailed information on the models of Common Sockets that are certified for standards.

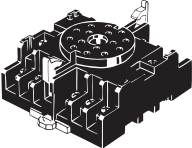
Round Sockets

Model Number of pins	PF (front-mounting), page 21	P2CF (front-mounting), page 22	PFA (front-mounting), page 23	P3G (back-mounting), page 24	PL (back-mounting), page 25			
					Solder terminals	Wrapping terminals	PCB terminals	
8 pins	PF083A Approx. 34 g  PF083A-E *  PF085A Approx. 40 g 	P2CF-08 Approx. 55 g  P2CF-08-E 	8PFA Approx. 57 g  8PFA1 Approx. 66 g 	P3G-08 Approx. 40 g  Note: The Y92A-48G Terminal Cover can be used to provide finger protection.	PL08 Approx. 14 g 	PL08-Q Approx. 15 g 	PLE08-0 Approx. 10.6 g 	
	11 pins	PF113A Approx. 47 g  PF113A-E * 	P2CF-11 Approx. 70 g  P2CF-11-E 	11PFA Approx. 74 g 	P3GA-11 Approx. 47 g  Note: The Y92A-48G Terminal Cover can be used to provide finger protection.	PL11 Approx. 15 g 	PL11-Q Approx. 18.5A 	PLE11-0 Approx. 10.8 g 
		14 pins	---	---	14PFA Approx. 104 g 	---	PL15 Approx. 28 g 	---
20 pins	---	---	---	---	PL20 Approx. 17 g 	---	---	

Note: The structure of □-E models provides finger protection. Round terminals cannot be used. Use forked crimp terminals.
* Use a #1 Phillips screwdriver to tighten the screws on this Socket.

Terminal Cover

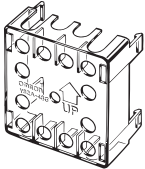
Model	Y92A-48G
Appearance	

Note: Refer to Models with Standards Certification for detailed information on the models of Common Sockets that are certified for standards.

Hold-down Clips For Square Sockets

(Unit: mm)

<p>PKC One Set (2 Clips)</p>	<p>PTC-1</p>	<p>PYC-A1 Approx. 0.54 g One Set (2 Clips)</p>	<p>PYC-A2 One Set (2 Clips)</p>	<p>PYC-E1 One Set (2 Clips)</p>	<p>PYC-P Approx. 1.4 g</p>
<p>PYC-P2 Approx. 1.2 g</p>	<p>PYC-S Approx. 1.8 g</p>	<p>PYC-1 Approx. 6 g</p>	<p>PYC-2</p>	<p>PYC-3</p>	<p>PYC-5</p>
<p>PYC Approx. 0.2 g</p>	<p>Y92H-1</p>	<p>Y92H-3 One Set (2 Clips) Approx. 5</p>	<p>Y92H-4</p>		

For Round Sockets

<p>PFC-A1 Approx. 2.2 g One Set (2 Clips)</p>	<p>PFC-A6 Approx. 2.4 g One Set (2 Clips)</p>	<p>PFC-A7 Approx. 3.0 g One Set (2 Clips)</p>	<p>PLC Approx. 2.4 g One Set (2 Clips)</p>	<p>PLC-1 Approx. 2.6 g One Set (2 Clips)</p>	<p>PLC-7 Approx. 3.0 g One Set (2 Clips)</p>
<p>PLC-8 Approx. 6.4 g One Set (2 Clips)</p>	<p>PLC-10 Approx. 2.0 g One Set (2 Clips)</p>	<p>PLC-12 Approx. 5.4 g One Set (2 Clips)</p>			

Applicable Hold-down Clips

For Square Sockets

Sockets Applicable models	PYFZ-□ PYF□A PTF□A	PYF08M	PY□(QN) PT□(QN)	PY□-02 PT□-0
MY□, MY□N, MY□-D, MY2□-CR, MY4□-CR, MY42□-CR, MY□-TU, MY2K, MY□N-D2, LY□, LY□N, LY□-TU, MYQ□, G3H(D) Series, G3F(D) Series, G3FM, and G9H	PYC-A1	PYC PYC-P	PYC-P PYC-S	PYC-P
MY□ * LY□		---	PYC-P2	
MY4H		---	PYC-P	
MY22□-CR MY3□-CR LY□-CR	Y92H-3	---	PYC-1	
G7K	PKC	---		
H3Y	Y92H-3	Y92H-4		

Note: The □ in the model number is replaced with 08, 11, or 14.

* If you use a Hold-down Clip with the MY2I, you cannot use the PYF08A.

Use the PYF14A.

For Round Sockets

Sockets Applicable models	PF083A PF113A	PL08 (-Q) PL11 (-Q)	PLE08-0 PLE11-0	P2CF-11
61F-03B, -04B	PFC-A1	PLC	PLC-10	---
61F-GP-N, -GPN-BT 61F-GP-N8 ?61F-APN2	PFC-N8	PHC-5		
MK2P Series, MK2KP, MK3P□(-US), and G3B(D) Series	PFC-A1	PLC		
MK3ZP MK3LP		PLC-1		
MYA-NA1, -NB1 MYA-LA1, -LB1 MYA-NA2, -NB2 MYA-LA2, -LB2	PFC-A6	PLC-7	---	---
MYA-LA12, -LB12	PFC-A7	PLC-8	---	---
APR-S	PFC-A6	PLC-7	---	---
APR-S380/-S440	---	---	---	Y92H-1
LG2	PFC-A7	PLC-8	---	---
K6EL	---	Y92H-1	---	---

Note: 1. The 8PFA(1), 11PFA, and 14PFA are held with hooks.

2. The PL15, PL20, and PF202, as well as models not given in the above table, require panel processing for installation.

3. The PF085A Hold-down Clip is included with the H3M and H2A. It is an option (sold separately) for the H2C.

Specifications

Socket Characteristics

Model	Continuous carry current	Dielectric strength	Insulation resistance*	Remarks
P2RFZ-05-E	10 A	Between contact terminals of same polarity: 1,000 VAC for 1 min	1,000 MΩ min.	
		Between coil and contact terminals: 4,000 VAC for 1 min		
P2RFZ-08-E	5 A	Between contact terminals of different polarity: 3,000 VAC for 1 min	1,000 MΩ min.	
		Between contact terminals of same polarity: 1,000 VAC for 1 min		
P2RF-05(-E)	10 A	Between coil and contact terminals: 4,000 VAC for 1 min	1,000 MΩ min.	
		Between contact terminals of same polarity: 1,000 VAC for 1 min		
P2RF-08(-E)	5 A	Between contact terminals of same polarity: 1,000 VAC for 1 min	1,000 MΩ min.	
		Between coil and contact terminals: 4,000 VAC for 1 min		
P2R-05P	10 A	Between contact terminals of same polarity: 1,000 VAC for 1 min	1,000 MΩ min.	
		Between coil and contact terminals: 4,000 VAC for 1 min		
P2R-08P	5 A	Between contact terminals of different polarity: 3,000 VAC for 1 min	1,000 MΩ min.	
		Between coil and contact terminals: 4,000 VAC for 1 min		
P2R-057P	10 A	Between contact terminals of same polarity: 1,000 VAC for 1 min	1,000 MΩ min.	
		Between coil and contact terminals: 5,000 VAC for 1 min		
P2R-087P	5 A	Between contact terminals of same polarity: 1,000 VAC for 1 min	1,000 MΩ min.	
		Between coil and contact terminals: 5,000 VAC for 1 min		
P2R-05A	10 A	Between ground terminals: 1,500 VAC for 1 min	1,000 MΩ min.	
		Between coil and contact terminals: 4,000 VAC for 1 min		
P2R-08A	5 A	Between contact terminals of different polarity: 3,000 VAC for 1 min	1,000 MΩ min.	
		Between ground terminals: 1,500 VAC for 1 min		
P7TF-05	5 A	Between terminals: 2,000 VAC for 1 min	1,000 MΩ min.	
		Between coil and contact terminals: 4,000 VAC for 1 min		
PYFZ-08(-E)	10 A	Between contact terminals of different polarity: 2,250 VAC for 1 min	1,000 MΩ min.	
		Between coil and contact terminals: 2,250 VAC for 1 min		
PYF08A(-E)	7 A	Between terminals: 2,000 VAC for 1 min	1,000 MΩ min.	The continuous carry current of 10 A for the PYF08S is for an ambient temperature of 55°C. At an ambient temperature of 70°C, the value is 7 A.
PYF11A	5 A	Between terminals: 2,000 VAC for 1 min	1,000 MΩ min.	
PYFZ-14(-E)	6 A	Between contact terminals of different polarity: 2,250 VAC for 1 min	1,000 MΩ min.	
		Between coil and contact terminals: 2,250 VAC for 1 min		
PYF14A(-E)	3 A	Between terminals: 2,000 VAC for 1 min	1,000 MΩ min.	
PY08(-Y1)(-Y3)	7 A	Between terminals: 1,500 VAC for 1 min	1,000 MΩ min.	
PY08QN(-Y1)	7 A	Between terminals: 1,500 VAC for 1 min	100 MΩ min.	
PY08-02	7 A	Between terminals: 1,500 VAC for 1 min	100 MΩ min.	
PY11(-Y1)	5 A	Between terminals: 1,500 VAC for 1 min	100 MΩ min.	
PY11QN(-Y1)	5 A	Between terminals: 1,500 VAC for 1 min	100 MΩ min.	
PY11-02	5 A	Between terminals: 1,500 VAC for 1 min	100 MΩ min.	
PY14(-Y1)(-Y3)	3 A	Between terminals: 1,500 VAC for 1 min	100 MΩ min.	
PY14QN(-Y1)	3 A	Between terminals: 1,500 VAC for 1 min	100 MΩ min.	
PY14-02	3 A	Between terminals: 1,500 VAC for 1 min	100 MΩ min.	
PTF□□A(-E)	10 A	Between terminals: 2,000 VAC for 1 min	100 MΩ min.	
PT□□	10 A	Between terminals: 2,000 VAC for 1 min	100 MΩ min.	
PT□□QN	10 A	Between terminals: 2,000 VAC for 1 min	100 MΩ min.	
PT□□-0	10 A	Between terminals: 2,000 VAC for 1 min	100 MΩ min.	
P7LF-06	30 A	Between contact terminals of different polarity: 2,000 VAC for 1 min	1,000 MΩ min.	
		Between coil and contact terminals: 4,000 VAC for 1 min		
PF□□□A(-E)	5 A	Between terminals: 2,000 VAC for 1 min	1,000 MΩ min.	
P2CF-□(-E)	5 A	Between terminals: 2,000 VAC for 1 min	1,000 MΩ min.	
8PFA(1)	10 A	Between terminals: 2,000 VAC for 1 min	1,000 MΩ min.	
11PFA(1)	10 A	Between terminals: 2,000 VAC for 1 min	1,000 MΩ min.	
P3G(A)-□	6 A	Between terminals: 2,000 VAC for 1 min	1,000 MΩ min.	
PL□(-Q)	10 A	Between terminals: 2,000 VAC for 1 min	1,000 MΩ min.	
PLE□□-0	10 A	Between terminals: 2,000 VAC for 1 min	1,000 MΩ min.	

* The insulation resistance was measured with a 500-VDC insulation resistance meter at the same places as those used for measuring the dielectric strength.

Safety Precautions

Refer to *Common Relay Precautions* for general precautions.

Dimensions

P2RF

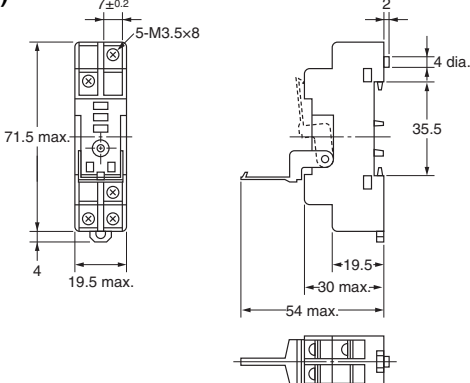
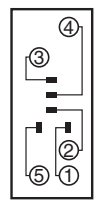
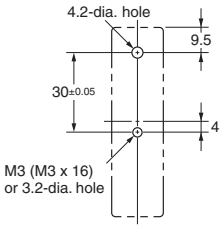
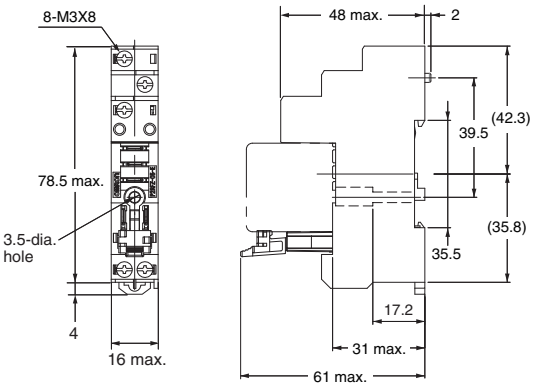
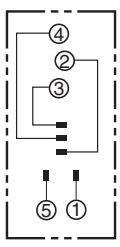
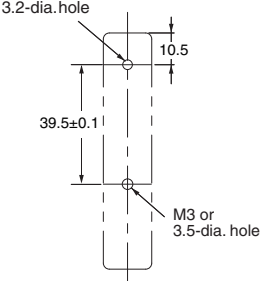
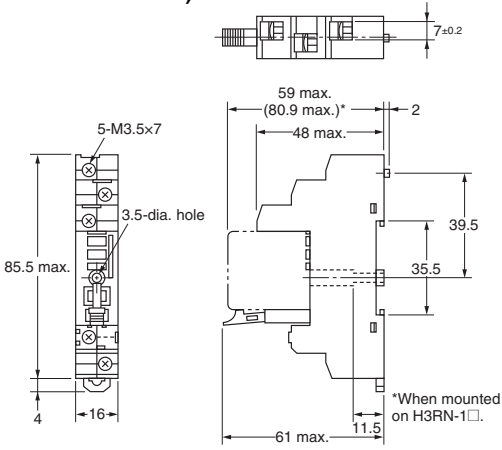
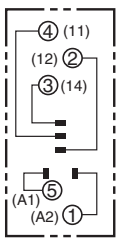
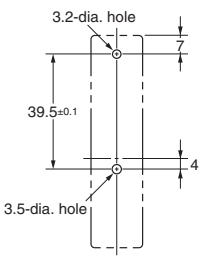

(Unit: mm)

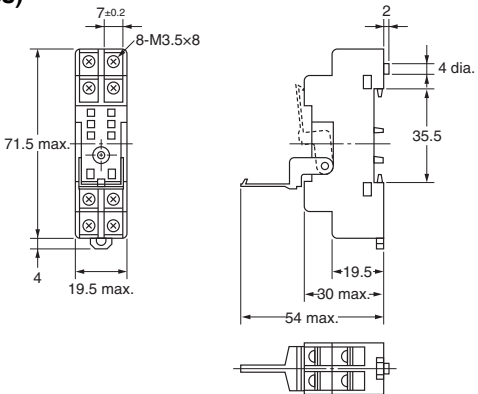
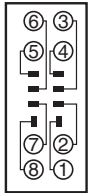
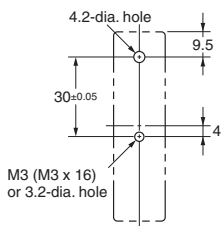
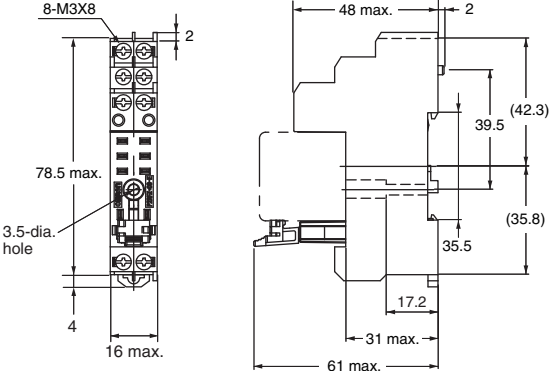
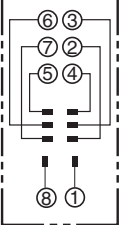
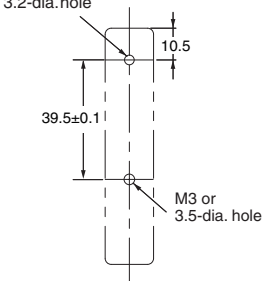
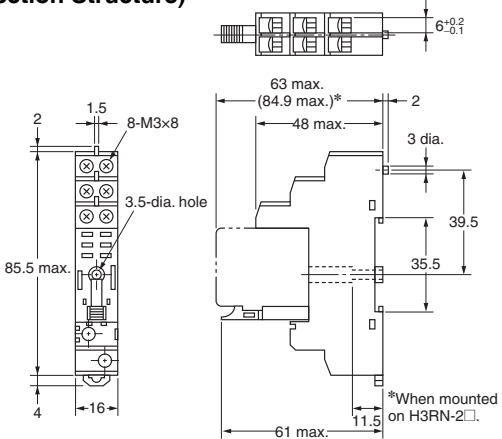
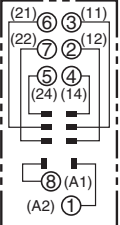
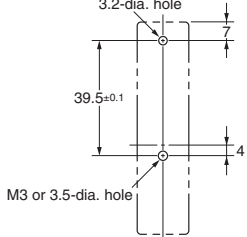
Dimensions	Terminal Arrangement/ Internal Connections	Mounting Hole Dimensions
<p>P2RF-05 (One Pole)</p> 	 <p>(Top View)</p>	 <p>(Top View)</p> <p>Note: Track mounting is also possible.</p>
<p>P2RFZ-05-E (One Pole) (Finger Protection Structure)</p> 	 <p>(Top View)</p>	 <p>(Top View)</p> <p>Note: Track mounting is also possible.</p>
<p>P2RF-05-E (One Pole) (Finger Protection Structure)</p> 	 <p>(Top View)</p> <p>Note: Figures in parentheses indicate DIN standard numbers.</p>	 <p>(Top View)</p> <p>Note: Track mounting is also possible.</p>

Dimensions	Terminal Arrangement/ Internal Connections	Mounting Hole Dimensions
<p>P2RF-08 (Two Poles)</p> 	 <p>(Top View)</p>	 <p>(Top View)</p> <p>Note: Track mounting is also possible.</p>
<p>P2RFZ-08-E (Two Poles) (Finger Protection Structure)</p> 	 <p>(Top View)</p>	 <p>(Top View)</p> <p>Note: Track mounting is also possible.</p>
<p>P2RF-08-E (Two Poles) (Finger Protection Structure)</p> 	 <p>(Top View)</p> <p>Note: Figures in parentheses indicate DIN standard numbers.</p>	 <p>(Top View)</p> <p>Note: Track mounting is also possible.</p>

Note: If an I/O SSR or Indicator Module is used, the polarity of terminal 1 is negative.

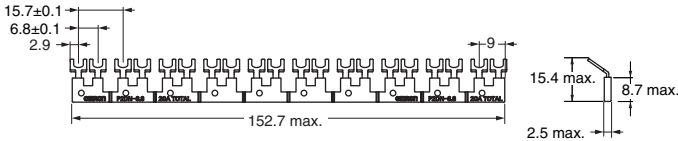
**Accessories for Screw Terminal Sockets (P2RFZ-□-E)
Short Bars**

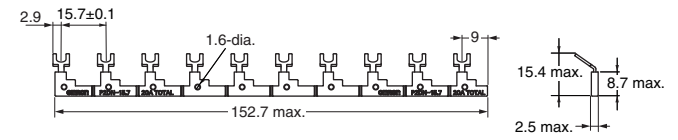
Pitch	Applicable models	Appearance	Dimensions (mm)	Model	Maximum carry current
6.8 mm	P2RFZ-05-E P2RFZ-08-E			P2DN-6.8-100S	20 A
15.7 mm				P2DN-15.7-100S	

Note: Each Short Bar set comes with 20 Caps.

**Accessories for Short Bars (P2DN)
Cap**

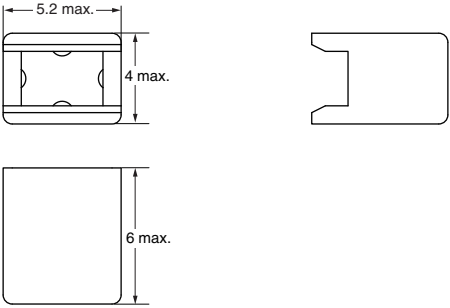
Applicable models	Appearance	Dimensions (mm)	Model
P2RFZ-05-E P2RFZ-08-E			P2DN-CP100

P2R

(Unit: mm)

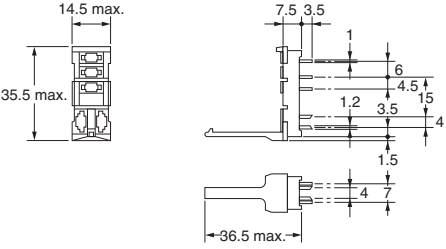
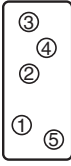
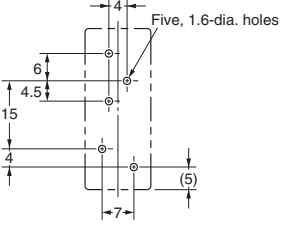
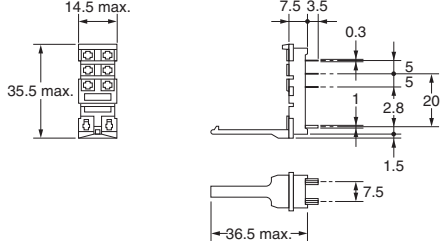
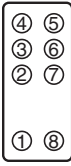
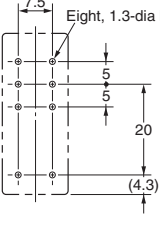
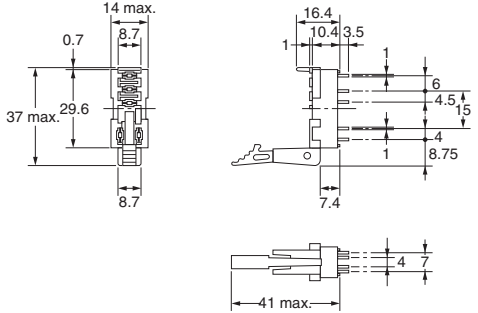
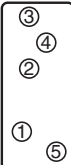
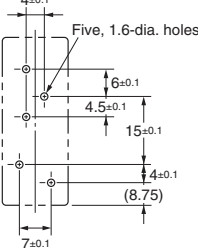
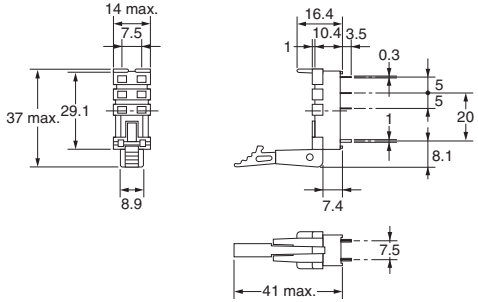
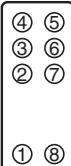
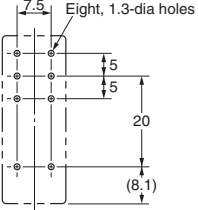
Dimensions	Terminal Arrangement/ Internal Connections	PCB Dimensions
<p>P2R-05P (One Pole)</p> 	 <p>(Bottom View)</p>	 <p>(Bottom View)</p>
<p>P2R-08P (Two Poles)</p> 	 <p>(Bottom View)</p>	 <p>(Bottom View)</p>
<p>P2R-057P (One Pole)</p> 	 <p>(Bottom View)</p>	 <p>(Bottom View)</p>
<p>P2R-087P (Two Poles)</p> 	 <p>(Bottom View)</p>	 <p>(Bottom View)</p>

Note: If an I/O SSR or Indicator Module is used, the polarity of terminal 1 is negative.

P2R

(Unit: mm)

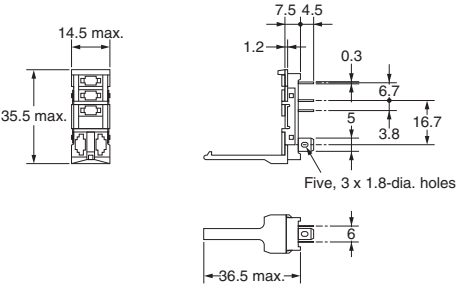
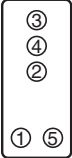
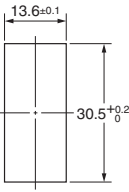
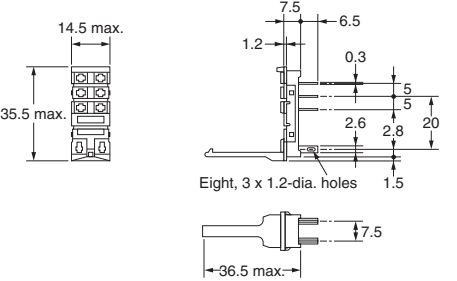
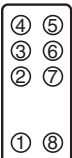
Dimensions	Terminal Arrangement/ Internal Connections	Mounting Hole Dimensions
<p>P2R-05A (One Pole)</p> 	 <p>(Bottom View)</p>	 <p>(Use panel with thickness of 1.6 to 2.0 mm.)</p>
<p>P2R-08A (Two Poles)</p> 	 <p>(Bottom View)</p>	<p>(Use panel with thickness of 1.6 to 2.0 mm.)</p>

Note: If an I/O SSR or Indicator Module is used, the polarity of terminal 1 is negative.

P7TF

(Unit: mm)

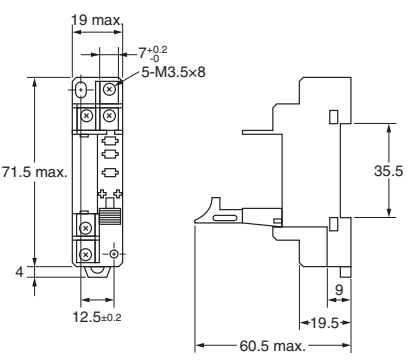
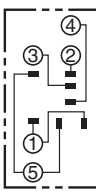
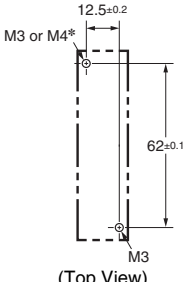
Dimensions	Terminal Arrangement/ Internal Connections	Mounting Hole Dimensions
<p>P7TF-05</p> 	 <p>(Top View)</p>	 <p>(Top View)</p> <p>Note: Track mounting is also possible. * We recommend that you use washers if you use M3 bolts or screws. Washers are not required with M4 bolts or screws.</p>

Note: If an I/O SSR or Indicator Module is used, the polarity of terminal 1 is positive.

PYFZ/PYF

(Unit: mm)

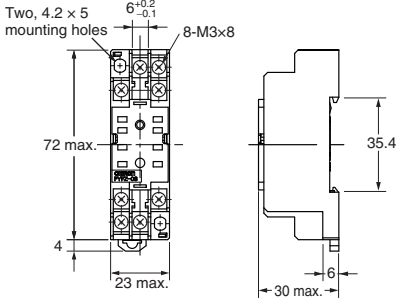
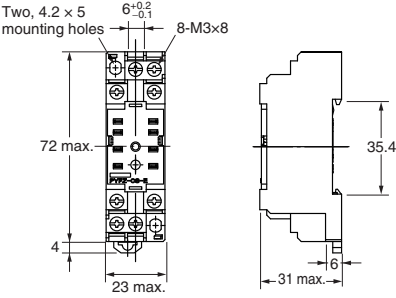
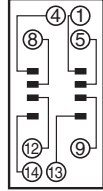
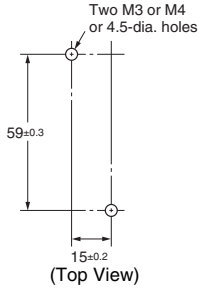
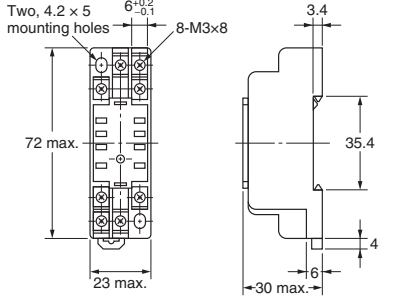
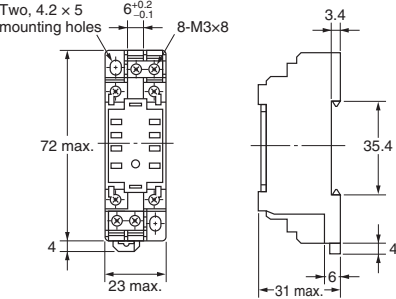
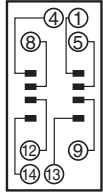
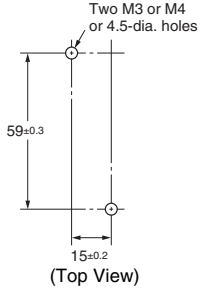
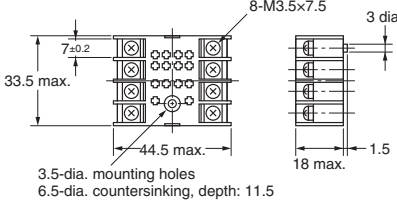
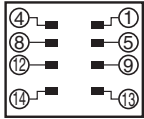
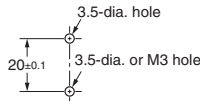
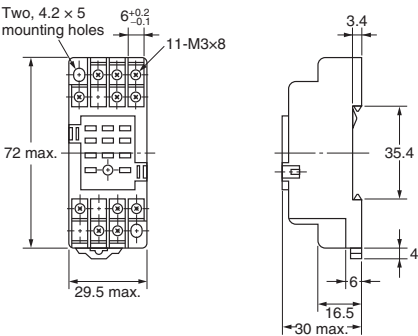
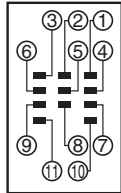
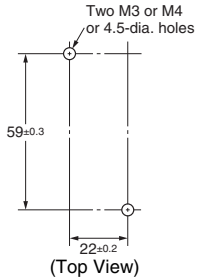
Dimensions	Terminal Arrangement/Internal Connections	Mounting Hole Dimensions
<p>PYFZ-08</p>  <p>PYFZ-08-E (Finger Protection Structure)</p> 	 <p>(Top View)</p>	 <p>Two M3 or M4 or 4.5-dia. holes</p> <p>59±0.3</p> <p>15±0.2</p> <p>(Top View)</p> <p>Note: Track mounting is also possible.</p>
<p>PYF08A *1</p>  <p>PYF08A-E *1 (Finger Protection Structure)</p> 	 <p>(Top View)</p>	 <p>Two M3 or M4 or 4.5-dia. holes</p> <p>59±0.3</p> <p>15±0.2</p> <p>(Top View)</p> <p>Note: Track mounting is also possible.</p>
<p>PYF08M</p>  <p>8-M3.5x7.5</p> <p>3 dia.</p> <p>7±0.2</p> <p>33.5 max.</p> <p>44.5 max.</p> <p>3.5-dia. mounting holes</p> <p>6.5-dia. countersinking, depth: 11.5</p> <p>18 max.</p>	 <p>(Top View)</p>	 <p>3.5-dia. hole</p> <p>20±0.1</p> <p>3.5-dia. or M3 hole</p> <p>(Top View)</p>
<p>PYF11A</p>  <p>Two, 4.2 x 5 mounting holes</p> <p>6±0.2</p> <p>11-M3x8</p> <p>72 max.</p> <p>29.5 max.</p> <p>35.4</p> <p>30 max.</p> <p>4</p> <p>6</p> <p>16.5</p>	 <p>(Top View)</p>	 <p>Two M3 or M4 or 4.5-dia. holes</p> <p>59±0.3</p> <p>22±0.2</p> <p>(Top View)</p> <p>Note: Track mounting is also possible.</p>

*1. Scheduled to be discontinued in March 2021.

PYFZ/PYF

(Unit: mm)

Dimensions		Terminal Arrangement/Internal Connections	Mounting Hole Dimensions
<p>PYFZ-14</p>	<p>PYFZ-14-E (Finger Protection Structure)</p>	<p>(Top View)</p>	<p>(Top View)</p> <p>Note: Track mounting is also possible.</p>
<p>PYF14A *1</p>	<p>PYF14A-E *1 (Finger Protection Structure)</p>	<p>(Top View)</p>	<p>(Top View)</p> <p>Note: Track mounting is also possible.</p>



*1. Scheduled to be discontinued in March 2021.

Relay Sockets and Short Bars for PYFZ/PYF Bridges within the Same Socket

Pitch	Applicable models	Appearance	Dimensions (mm)	Model	Specifications
7 mm	PYFZ-14 PYF14A			PYD-020B□(2P)	Max. carry current: 20 A (18 A at 70°C) Ambient operating temperature: -40 to 70°C (with no icing or condensation) Ambient operating humidity: 45% to 85% (with no icing or condensation) Conductor material: Brass Conductor surface treatment: Nickel plating Package qty: 50/bag
				PYD-030B□(3P)	

Note: The □ in the model number is replaced with the insulation color specification code. B: Black, Y: Yellow

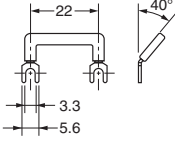
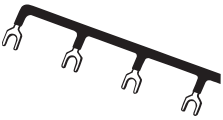
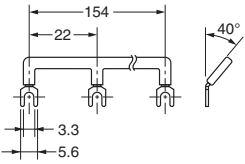
Bridges between Adjacent Sockets

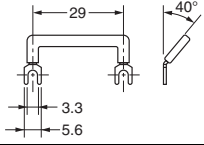
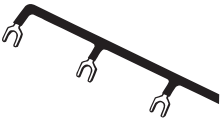
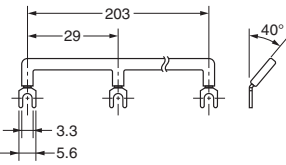
Pitch	Applicable models	Appearance	Dimensions (mm)	Model *1	Specifications
22 mm	PYFZ-08			PYD-025B□(2P)	Max. carry current: 20 A (18 A at 70°C) Ambient operating temperature: -40 to 70°C (with no icing or condensation) Ambient operating humidity: 45% to 85% (with no icing or condensation) Conductor material: Brass Conductor surface treatment: Nickel plating Package qty: 10/bag
	PYF08A *2			PYD-085B□(8P)	
29 mm	PYFZ-14			PYD-026B□(2P)	Max. carry current: 20 A (18 A at 70°C) Ambient operating temperature: -40 to 70°C (with no icing or condensation) Ambient operating humidity: 45% to 85% (with no icing or condensation) Conductor material: Brass Conductor surface treatment: Nickel plating Package qty: 10/bag
	PYF14A *2			PYD-086B□(8P)	

*1. The □ in the model number is replaced with the insulation color specification code. B: Black, S: Blue, R: Red
 *2. Scheduled to be discontinued in March 2021.

Terminal Covers for PYFZ-08/PYFZ-14

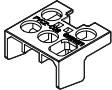
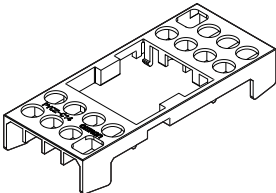
Applicable models	Appearance	Model
PYFZ-08		PYCZ-C08 (2 pcs/set)
PYFZ-14		PYCZ-C14 (1 pcs/set)

Note: These covers cannot be used for PYF08A and PYF14A.
 Use these covers in a combination with PYFZ-08 and PYFZ-14.

Dimensions with terminal cover

(Unit: mm)

PYCZ-C08

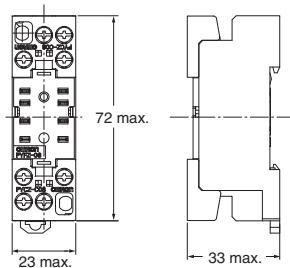

PYCZ-C14

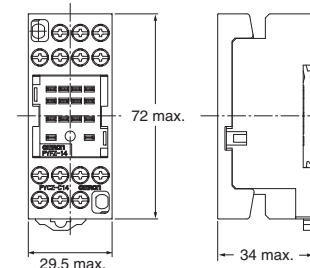

PY

(Unit: mm)

Dimensions	Terminal Arrangement/ Internal Connections	Mounting hole and PCB dimensions
<p>PY08 PY08-Y1 (L = 42 max.) PY08-Y13 (L = 60 max.)</p> <p>*The PY08-Y□ includes the part outlined by the dashed lines above.</p>		
<p>PY08QN PY08QN2 PY08QN-Y1 PY08QN2-Y1</p> <p>*1. The PY08QN(2)-Y1 includes the part outlined by the dashed lines above. *2. The figures in the parentheses are for the PY08QN2(-Y1).</p>	<p>(Bottom View)</p>	
<p>PY08-02</p> <p>* The structure does not resist flux. Manual soldering is recommended for this product.</p>		
<p>PY11 PY11-Y1</p> <p>*The PY11-Y1 includes the part outlined by the dashed lines above.</p>		
<p>PY11QN PY11QN2 PY11QN-Y1 PY11QN2-Y1</p> <p>*1. The PY11QN(2)-Y1 includes the part outlined by the dashed lines above. *2. The figures in the parentheses are for the PY11QN2(-Y1).</p>	<p>(Bottom View)</p>	
<p>PY11-02</p> <p>* The structure does not resist flux. Manual soldering is recommended for this product.</p>		

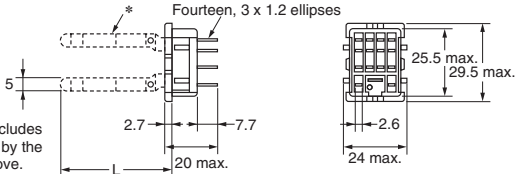
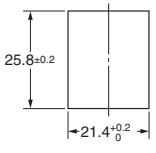
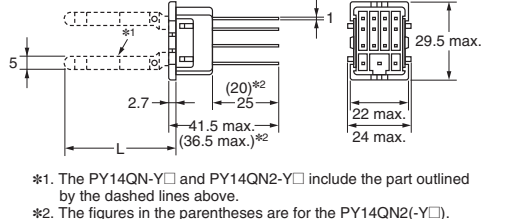
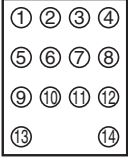
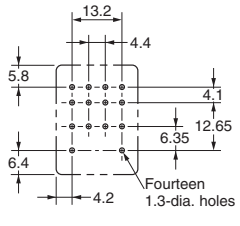
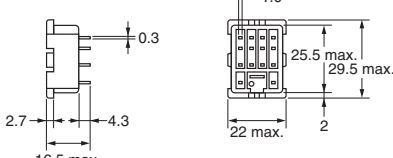
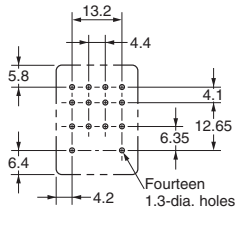
Dimensions	Terminal Arrangement/ Internal Connections	Mounting hole and PCB dimensions
<p>PY14 PY14-Y1 (L = 42 max.) PY14-Y3 (L = 60 max.)</p>  <p>*The PY14-Y□ includes the part outlined by the dashed lines above.</p>		
<p>PY14QN PY14QN2 PY14QN-Y1 (L = 42 max.) PY14QN2-Y1 (L = 42 max.) PY14QN-Y3 (L = 60 max.) PY14QN2-Y3 (L = 60 max.)</p>  <p>*1. The PY14QN-Y□ and PY14QN2-Y□ include the part outlined by the dashed lines above. *2. The figures in the parentheses are for the PY14QN2(-Y□).</p>	 <p>(Bottom View)</p>	
<p>PY14-02</p> <p>* The structure does not resist flux. Manual soldering is recommended for this product.</p> 		

- Note:**
1. Use a panel with a thickness of 1 to 2 mm when mounting a Socket on it.
 2. You can use the PY14-Y1 or PY14QN-Y1 for the MY4 Series, MY4H, MYQ4(Z), or MY2K.
 3. You can use the PY14-Y3 or PY14QN-Y3 for H3Y Timers.

PTF

(Unit: mm)

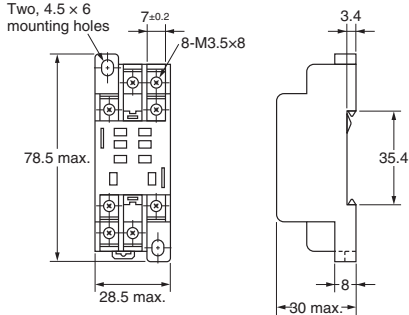
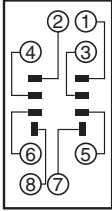
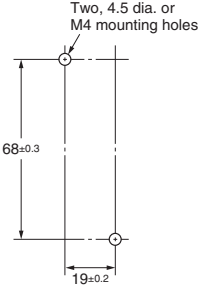
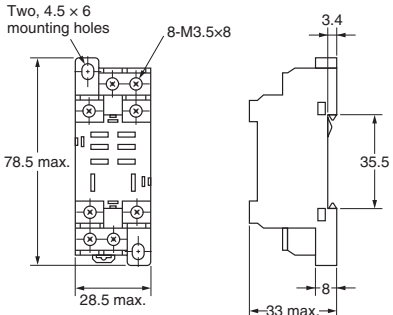
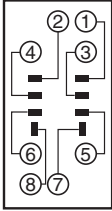
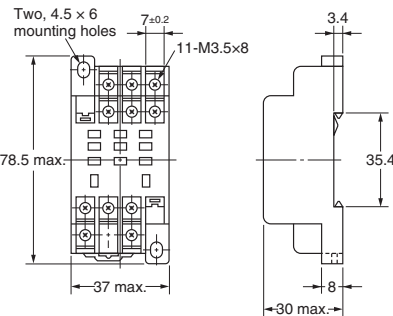
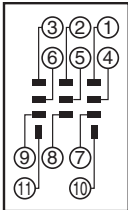
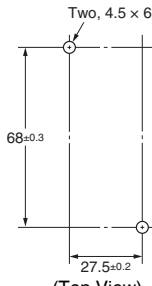
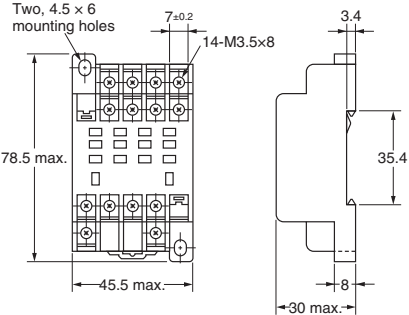
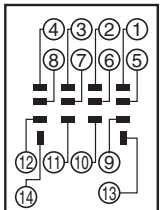
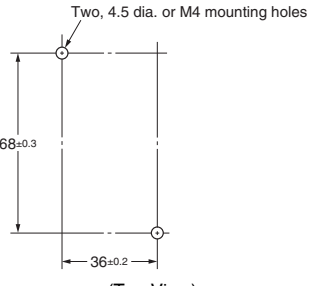
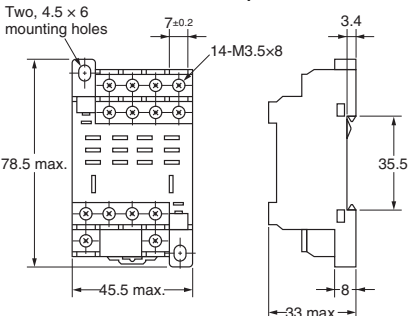
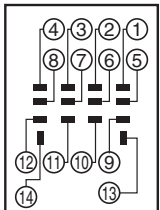
Dimensions	Terminal Arrangement/ Internal Connections	Mounting Hole Dimensions
<p>PTF08A</p> 	 <p>(Top View)</p>	 <p>(Top View)</p>
<p>PTF08A-E (Finger Protection Structure)</p> 	 <p>(Top View)</p>	<p>Note: Track mounting is also possible.</p>
<p>PTF11A</p> 	 <p>(Top View)</p>	 <p>(Top View)</p> <p>Note: Track mounting is also possible.</p>
<p>PTF14A</p> 	 <p>(Top View)</p>	 <p>(Top View)</p> <p>Note: Track mounting is also possible.</p>
<p>PTF14A-E (Finger Protection Structure)</p> 	 <p>(Top View)</p>	<p>Note: Track mounting is also possible.</p>

Note: If you use the PTF08A, PTF08A-E, or PT08 with an LY1 Relay, connect the following terminal pairs: 1-2, 3-4, and 5-6 (for usage at 10 A or higher).

PT

(Unit: mm)

Dimensions		Terminal Arrangement/ Internal Connections	Mounting hole and PCB dimensions	
<p>PT08</p> <p>20.5 max. Eight, 1.7-dia x 3.5 oblong holes</p>	<p>PT08QN</p>	<p>(Bottom View)</p>		
<p>PT08-0</p> <p>*Maintain a sufficient distance from the pattern when using double-sided PCBs. • The structure does not resist flux. Manual soldering is recommended for this product.</p>	<p>PT08-0</p>		<p>(Bottom View)</p>	<p>Eight, 2.5-dia. holes (±0.1 tolerance)</p>
<p>PT11</p> <p>Eleven, 1.7-dia x 3.5 holes</p>	<p>PT11QN</p>		<p>(Bottom View)</p>	
<p>PT11-0</p> <p>*Maintain a sufficient distance from the pattern when using double-sided PCBs. • The structure does not resist flux. Manual soldering is recommended for this product.</p>	<p>PT11-0</p>			<p>(Bottom View)</p>

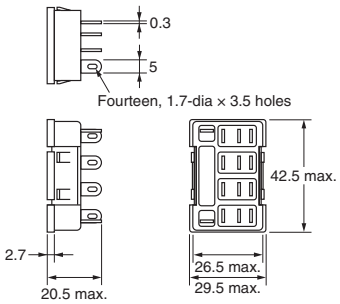
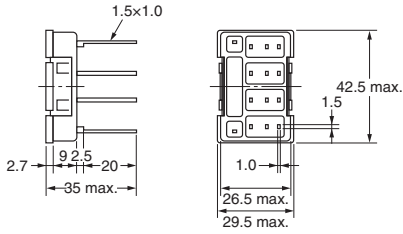
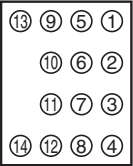
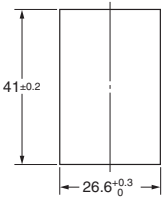
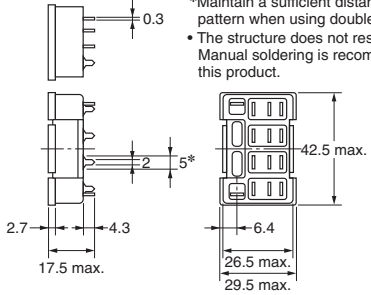
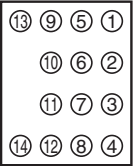
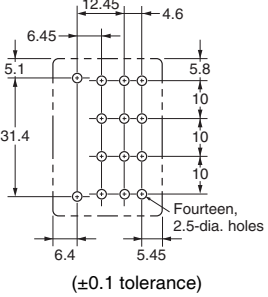
Dimensions	Terminal Arrangement/ Internal Connections	Mounting hole and PCB dimensions
<p>PT14</p>  <p>PT14QN</p> 	 <p>(Bottom View)</p>	
<p>PT14-0</p>  <p>*Maintain a sufficient distance from the pattern when using double-sided PCBs. • The structure does not resist flux. • Manual soldering is recommended for this product.</p>	 <p>(Bottom View)</p>	 <p>(±0.1 tolerance)</p>

Note: Use a panel with a thickness of 1 to 2 mm when mounting a Socket on it.

P7LF

(Unit: mm)

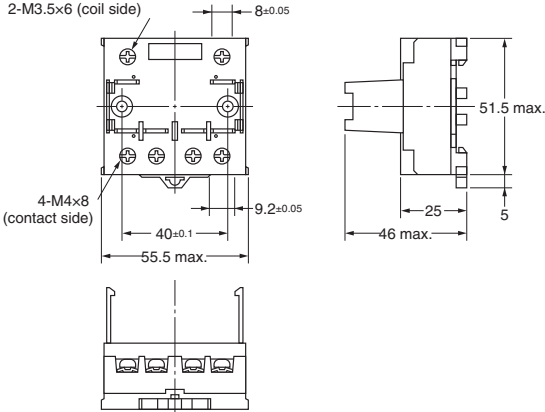
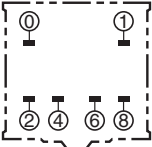
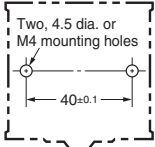
Dimensions	Terminal Arrangement/ Internal Connections	Mounting Hole Dimensions
<p>P7LF-06</p> 	 <p>(Top View)</p>	 <p>Two, 4.5 dia. or M4 mounting holes 40±0.1</p>

PF

(Unit: mm)

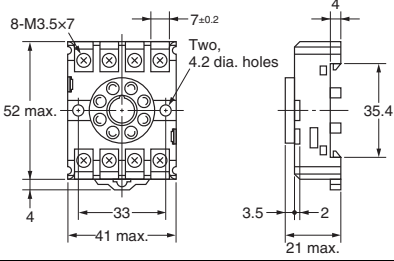
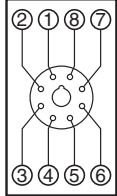
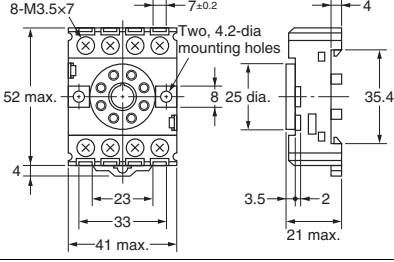
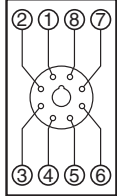
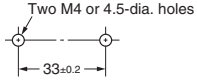
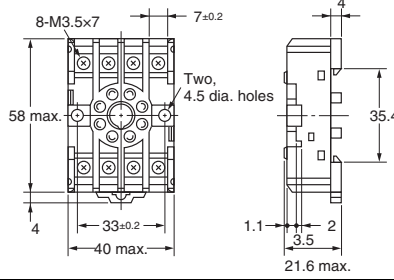
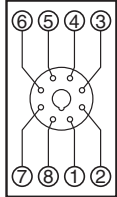
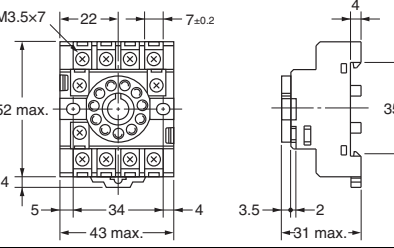
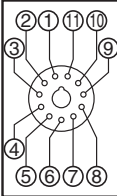
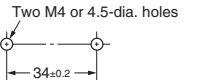
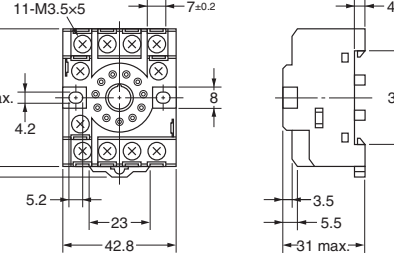
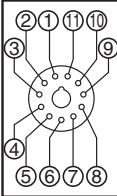
Dimensions	Terminal Arrangement/ Internal Connections	Mounting Hole Dimensions
<p>PF083A</p> 	 <p>(Top View)</p>	
<p>PF083A-E</p> 	 <p>(Top View)</p>	 <p>Note: Track mounting is also possible.</p>
<p>PF085A</p> 	 <p>(Top View)</p>	
<p>PF113A</p> 	 <p>(Top View)</p>	 <p>Note: Track mounting is also possible.</p>
<p>PF113A-E</p> 	 <p>(Top View)</p>	<p>Note: Track mounting is also possible.</p>

Note: 1. For the PF083A and PF113A, the Socket key slot is on the top. (Applicable model: MK)

2. The structure of □-E models provides finger protection. Round terminals cannot be used. Use forked crimp terminals.

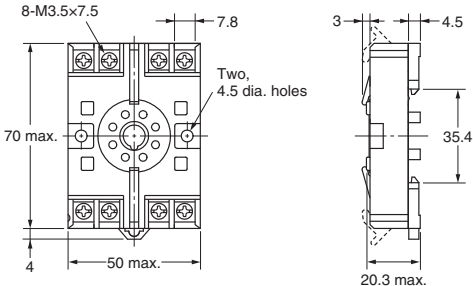
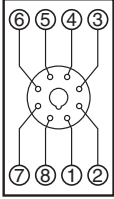
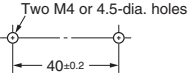
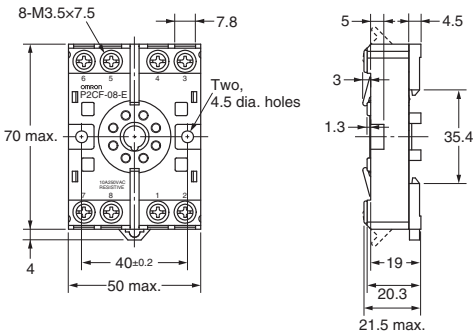
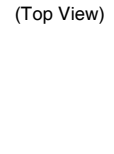
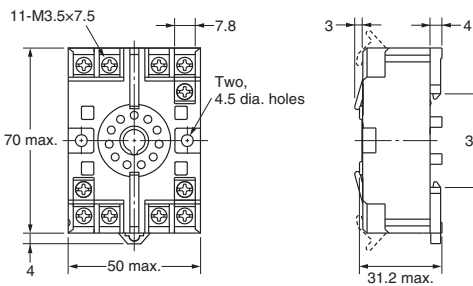
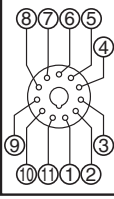
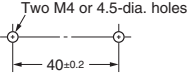
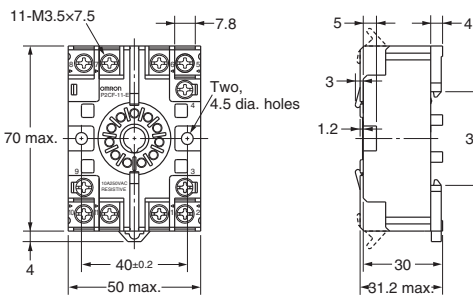
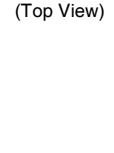

P2CF

(Unit: mm)

Dimensions	Terminal Arrangement/ Internal Connections	Mounting Hole Dimensions
<p>P2CF-08</p> 	 <p>(Top View)</p>	 <p>Two M4 or 4.5-dia. holes 40±0.2</p>
<p>P2CF-08-E</p> 	 <p>(Top View)</p>	<p>Note: Track mounting is also possible.</p>
<p>P2CF-11</p> 	 <p>(Top View)</p>	 <p>Two M4 or 4.5-dia. holes 40±0.2</p>
<p>P2CF-11-E</p> 	 <p>(Top View)</p>	<p>Note: Track mounting is also possible.</p>

PFA

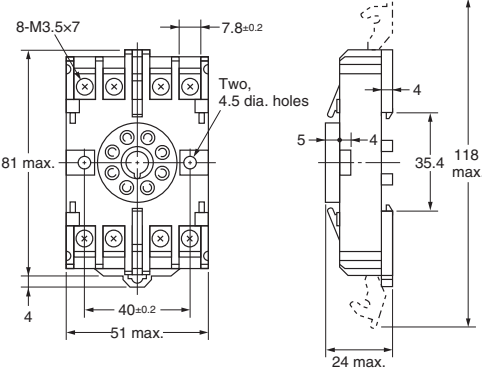
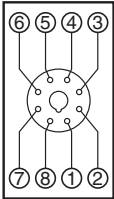
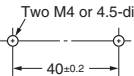
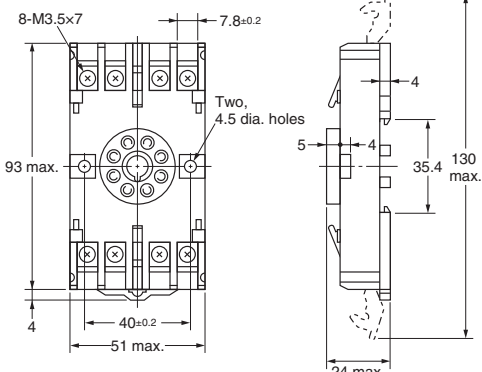
(Unit: mm)

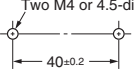
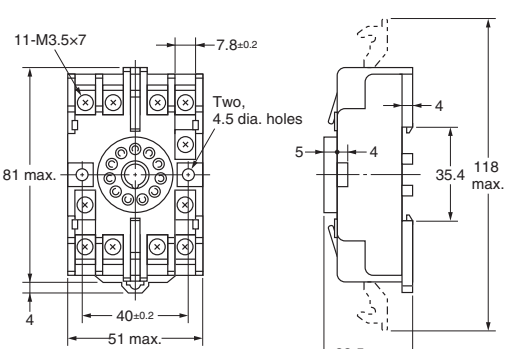
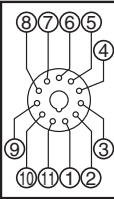
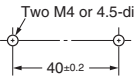
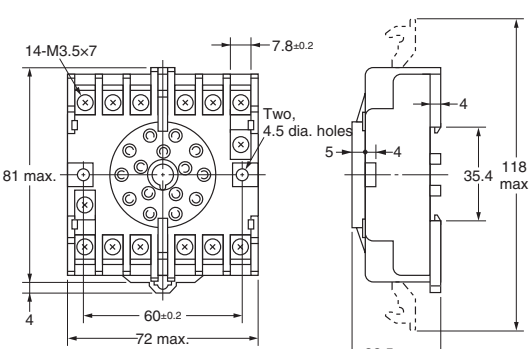
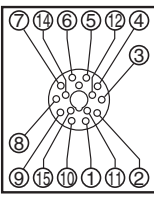
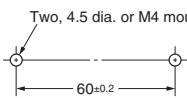
Dimensions	Terminal Arrangement/ Internal Connections	Mounting Hole Dimensions
<p>8PFA</p> 	 <p>(Top View)</p>	 <p>Note: Track mounting is also possible.</p>
<p>8PFA1</p> 	 <p>(Top View)</p>	 <p>Note: Track mounting is also possible.</p>
<p>11PFA</p> 	 <p>(Top View)</p>	 <p>Note: Track mounting is also possible.</p>
<p>14PFA</p> 	 <p>(Top View)</p>	 <p>Note: Track mounting is also possible.</p>

P3G/P3GA

(Unit: mm)

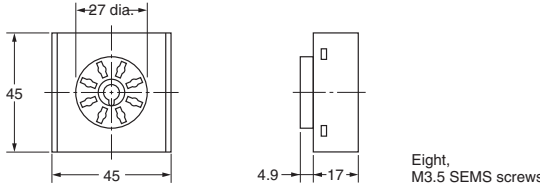
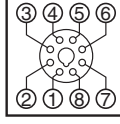
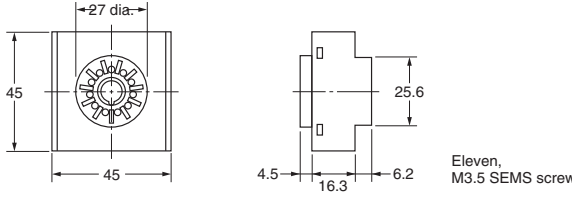
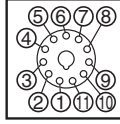
Dimensions	Terminal Arrangement/ Internal Connections	Mounting Hole Dimensions
<p>P3G-08</p>  <p>Eight, M3.5 SEMS screws</p> <p>Note: The Y92A-48G Terminal Cover can be used to implement finger protection.</p>	 <p>(Bottom View)</p>	<p>---</p>
<p>P3GA-11</p>  <p>Eleven, M3.5 SEMS screws</p> <p>Note: The Y92A-48G Terminal Cover can be used to implement finger protection.</p>	 <p>(Bottom View)</p>	<p>---</p>

Terminal Cover

(Unit: mm)

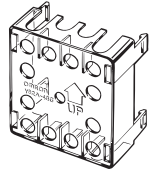
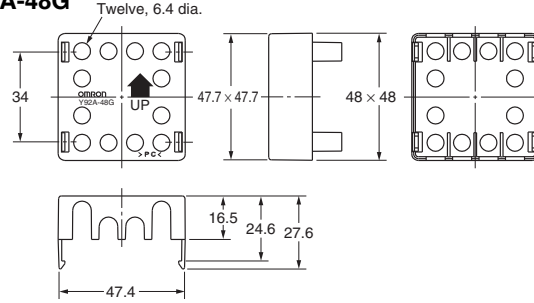
Appearance	Dimensions
	<p>Y92A-48G</p> <p>Twelve, 6.4 dia.</p>  <p>34</p> <p>47.7 × 47.7</p> <p>48 × 48</p> <p>16.5</p> <p>24.6</p> <p>27.6</p> <p>47.4</p> <p>UP</p>

PL

(Unit: mm)

Dimensions	Terminal Arrangement/ Internal Connections	Mounting hole and PCB dimensions (bottom view)
<p>PL08</p>		<p>Two, 3.5 dia. or M3 device mounting holes</p> <p>Two, 3.5 or M3 Socket mounting holes</p> <p>L = 40 mm MK2(Z)P L = 74 mm PU, AMD-S, MM2(X)P, CZ, STP, H3L, TDS, DTS, DSP, TDF, TDV L = 86 mm 61F-GP/-APN, G4Q-212S, RD2P, RDA, TDA, AGF, SE, SAD, K2CU, SDV-F</p>
<p>PL08-Q</p>	<p>(Bottom View)</p>	<p>Two 3.5-dia. or two M3 Socket mounting holes</p> <p>MK2(Z)P</p>
<p>PLE08-0</p>		<p>Two 3.5-dia. Hold-down Clip mounting holes</p> <p>MK2(Z)P</p>
<p>PL11</p>		<p>Two, 3.5 dia. or M3 device mounting /Hold-down Clip mounting holes</p> <p>Two, 3.5 dia. or M3 Socket mounting holes</p> <p>L = 40 mm MK3P MK2KP</p> <p>L = 74 mm MM3P MK2(X)KP</p>
<p>PL11-Q</p>	<p>(Bottom View)</p>	<p>L = 42 mm MK3ZP MK3LP</p>
<p>PLE11-0</p>		<p>Two, 3.5-dia. holes Applicable model/Hold-down Clip mounting holes</p> <p>L = 40 mm MK3P MK2KP</p> <p>L = 42 mm MK3ZP MK3LP</p>
<p>PL15</p>	<p>(Bottom View)</p>	<p>Two, 3.5 dia. or M3 device mounting holes</p> <p>Two, 3.5 dia. or M3 Socket mounting holes</p> <p>MM3XP MM4(X)P MM3(X)KP MM4(X)KP</p>

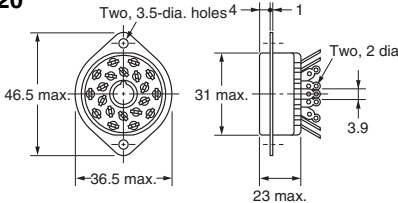
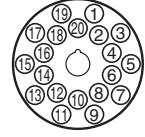
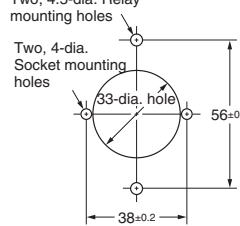
Dimensions	Terminal Arrangement/ Internal Connections	Mounting hole and PCB dimensions (bottom view)
<p>PL20</p>  <p>Two, 3.5-dia. holes 4 1 46.5 max. 31 max. Two, 2 dia. 3.9 36.5 max. 23 max.</p>	 <p>(Bottom View)</p>	 <p>Two, 4.5-dia. Relay mounting holes Two, 4-dia. Socket mounting holes 33-dia. hole 56±0.2 38±0.2</p> <p>* Relay mounting holes are not required for the LDNP.</p>

Note: When mounting, pay due attention to the direction of the key groove of applicable Relays.

Terms and Conditions Agreement

Read and understand this catalog.

Please read and understand this catalog before purchasing the products. Please consult your OMRON representative if you have any questions or comments.

Warranties.

(a) Exclusive Warranty. Omron's exclusive warranty is that the Products will be free from defects in materials and workmanship for a period of twelve months from the date of sale by Omron (or such other period expressed in writing by Omron). Omron disclaims all other warranties, express or implied.

(b) Limitations. OMRON MAKES NO WARRANTY OR REPRESENTATION, EXPRESS OR IMPLIED, ABOUT NON-INFRINGEMENT, MERCHANTABILITY OR FITNESS FOR A PARTICULAR PURPOSE OF THE PRODUCTS. BUYER ACKNOWLEDGES THAT IT ALONE HAS DETERMINED THAT THE PRODUCTS WILL SUITABLY MEET THE REQUIREMENTS OF THEIR INTENDED USE.

Omron further disclaims all warranties and responsibility of any type for claims or expenses based on infringement by the Products or otherwise of any intellectual property right. (c) Buyer Remedy. Omron's sole obligation hereunder shall be, at Omron's election, to (i) replace (in the form originally shipped with Buyer responsible for labor charges for removal or replacement thereof) the non-complying Product, (ii) repair the non-complying Product, or (iii) repay or credit Buyer an amount equal to the purchase price of the non-complying Product; provided that in no event shall Omron be responsible for warranty, repair, indemnity or any other claims or expenses regarding the Products unless Omron's analysis confirms that the Products were properly handled, stored, installed and maintained and not subject to contamination, abuse, misuse or inappropriate modification. Return of any Products by Buyer must be approved in writing by Omron before shipment. Omron Companies shall not be liable for the suitability or unsuitability or the results from the use of Products in combination with any electrical or electronic components, circuits, system assemblies or any other materials or substances or environments. Any advice, recommendations or information given orally or in writing, are not to be construed as an amendment or addition to the above warranty.

See <http://www.omron.com/global/> or contact your Omron representative for published information.

Limitation on Liability: Etc.

OMRON COMPANIES SHALL NOT BE LIABLE FOR SPECIAL, INDIRECT, INCIDENTAL, OR CONSEQUENTIAL DAMAGES, LOSS OF PROFITS OR PRODUCTION OR COMMERCIAL LOSS IN ANY WAY CONNECTED WITH THE PRODUCTS, WHETHER SUCH CLAIM IS BASED IN CONTRACT, WARRANTY, NEGLIGENCE OR STRICT LIABILITY.

Further, in no event shall liability of Omron Companies exceed the individual price of the Product on which liability is asserted.

Suitability of Use.

Omron Companies shall not be responsible for conformity with any standards, codes or regulations which apply to the combination of the Product in the Buyer's application or use of the Product. At Buyer's request, Omron will provide applicable third party certification documents identifying ratings and limitations of use which apply to the Product. This information by itself is not sufficient for a complete determination of the suitability of the Product in combination with the end product, machine, system, or other application or use. Buyer shall be solely responsible for determining appropriateness of the particular Product with respect to Buyer's application, product or system. Buyer shall take application responsibility in all cases.

NEVER USE THE PRODUCT FOR AN APPLICATION INVOLVING SERIOUS RISK TO LIFE OR PROPERTY OR IN LARGE QUANTITIES WITHOUT ENSURING THAT THE SYSTEM AS A WHOLE HAS BEEN DESIGNED TO ADDRESS THE RISKS, AND THAT THE OMRON PRODUCT(S) IS PROPERLY RATED AND INSTALLED FOR THE INTENDED USE WITHIN THE OVERALL EQUIPMENT OR SYSTEM.

Programmable Products.

Omron Companies shall not be responsible for the user's programming of a programmable Product, or any consequence thereof.

Performance Data.

Data presented in Omron Company websites, catalogs and other materials is provided as a guide for the user in determining suitability and does not constitute a warranty. It may represent the result of Omron's test conditions, and the user must correlate it to actual application requirements. Actual performance is subject to the Omron's Warranty and Limitations of Liability.

Change in Specifications.

Product specifications and accessories may be changed at any time based on improvements and other reasons. It is our practice to change part numbers when published ratings or features are changed, or when significant construction changes are made. However, some specifications of the Product may be changed without any notice. When in doubt, special part numbers may be assigned to fix or establish key specifications for your application. Please consult with your Omron's representative at any time to confirm actual specifications of purchased Product.

Errors and Omissions.

Information presented by Omron Companies has been checked and is believed to be accurate; however, no responsibility is assumed for clerical, typographical or proofreading errors or omissions.

2020.5

In the interest of product improvement, specifications are subject to change without notice.

OMRON Corporation
Industrial Automation Company

<http://www.ia.omron.com/>

(c)Copyright OMRON Corporation 2020 All Right Reserved.