

1759546-1 ✓ ACTIVE



Mini PCI Express, OEG Miniature Relay PCF

TE Internal #: 1759546-1

Board-to-Board, 52 Position, .8 mm [.031 in] Centerline, Stack Height 9.9 mm [.39 in], Gold Flash, Matte, Mini PCI Express, Mini PCI Express & mSATA

[View on TE.com >](#)

Connectors > PCB Connectors > Card Edge Connectors > Mini PCI Express & mSATA

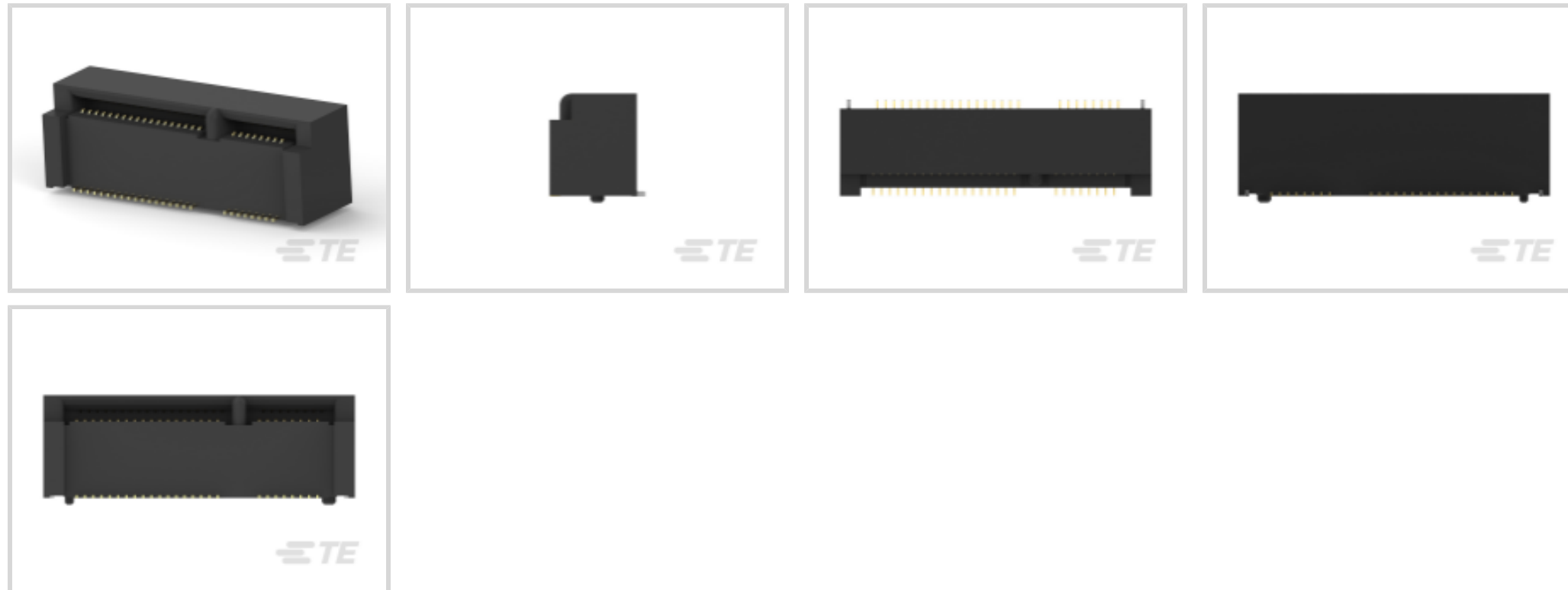

Bus Type: **Mini PCI Express**

Connector System: **Board-to-Board**

Number of Positions: **52**

Centerline (Pitch): **.8 mm [.031 in]**

Stack Height: **9.9 mm [.39 in]**

Features

Product Type Features

Connector & Contact Terminates To	Printed Circuit Board
Connector System	Board-to-Board

Configuration Features

Number of Positions	52
---------------------	----

Contact Features

Contact Base Material	Copper Alloy
Contact Mating Area Plating Material	Gold Flash
PCB Contact Termination Area Plating Material Finish	Matte
Contact Current Rating (Max)	.5 A

Housing Features

Centerline (Pitch)	.8 mm [.031 in]
--------------------	-----------------

Dimensions

Stack Height	9.9 mm [.39 in]
--------------	-----------------



Usage Conditions

Operating Temperature Range	-55 – 85 °C[-67 – 185 °F]
-----------------------------	---------------------------

Operation/Application

Circuit Application	Signal
---------------------	--------

Industry Standards

Bus Type	Mini PCI Express
----------	------------------

Packaging Features

Packaging Method	Tape & Reel
------------------	-------------

Product Compliance

[For compliance documentation, visit the product page on TE.com>](#)

EU RoHS Directive 2011/65/EU	Compliant
EU ELV Directive 2000/53/EC	Compliant
China RoHS 2 Directive MIIT Order No 32, 2016	No Restricted Materials Above Threshold
EU REACH Regulation (EC) No. 1907/2006	Current ECHA Candidate List: JUNE 2024 (241) Candidate List Declared Against: JUNE 2024 (241) Does not contain REACH SVHC
Halogen Content	Low Halogen - Br, Cl, F, I < 900 ppm per homogenous material. Also BFR/CFR/PVC Free
Solder Process Capability	Reflow solder capable to 260°C

Product Compliance Disclaimer

This information is provided based on reasonable inquiry of our suppliers and represents our current actual knowledge based on the information they provided. This information is subject to change. The part numbers that TE has identified as EU RoHS compliant have a maximum concentration of 0.1% by weight in homogenous materials for lead, hexavalent chromium, mercury, PBB, PBDE, DBP, BBP, DEHP, DIBP, and 0.01% for cadmium, or qualify for an exemption to these limits as defined in the Annexes of Directive 2011/65/EU (RoHS2). Finished electrical and electronic equipment products will be CE marked as required by Directive 2011/65/EU. Components may not be CE marked. Additionally, the part numbers that TE has identified as EU ELV compliant have a maximum concentration of 0.1% by weight in homogenous materials for lead, hexavalent chromium, and mercury, and 0.01% for cadmium, or qualify for an exemption to these limits as defined in the Annexes of Directive 2000/53/EC (ELV). Regarding the REACH Regulation, the information TE provides on SVHC in articles for this part number is based on the latest European Chemicals Agency (ECHA) 'Guidance on requirements for substances in articles' posted at this URL: <https://echa.europa.eu/guidance-documents/guidance-on-reach>

Compatible Parts



Also in the Series | Mini PCI Express

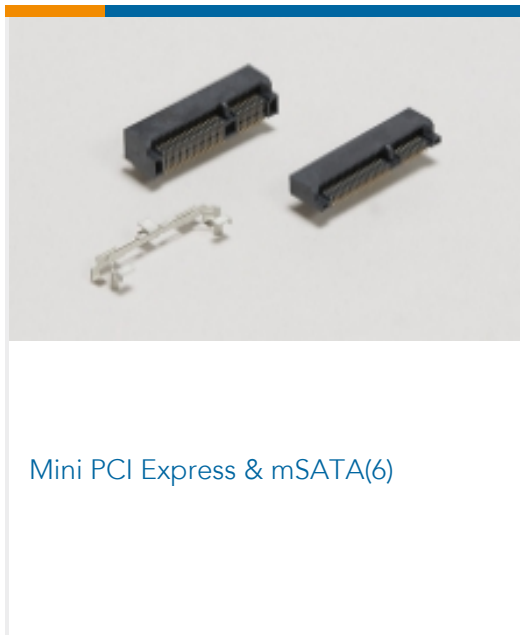

Also in the Series | OEG Miniature Relay PCF

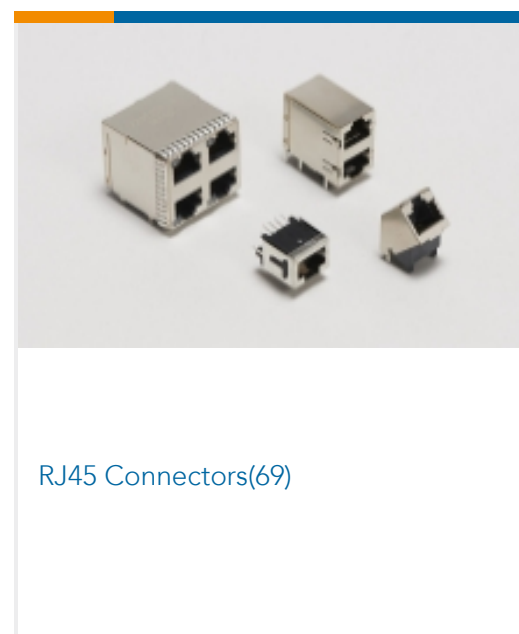
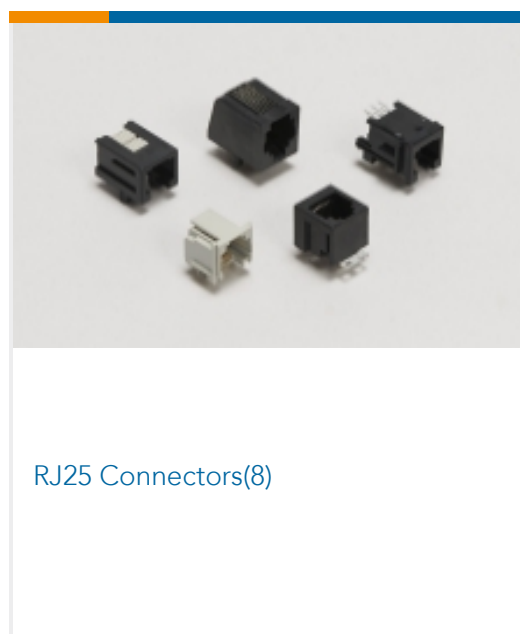
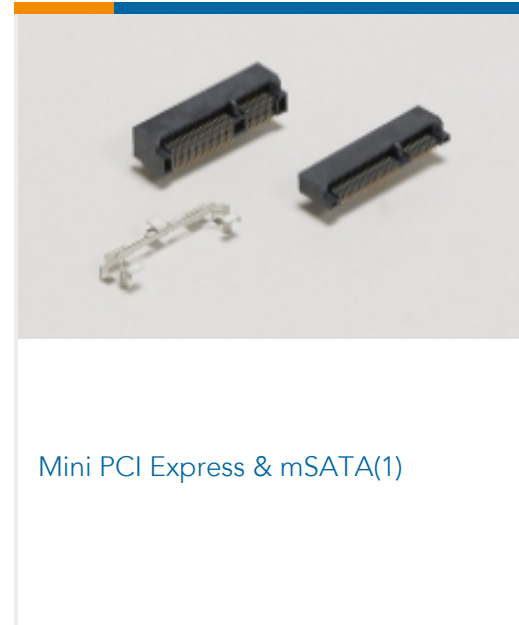
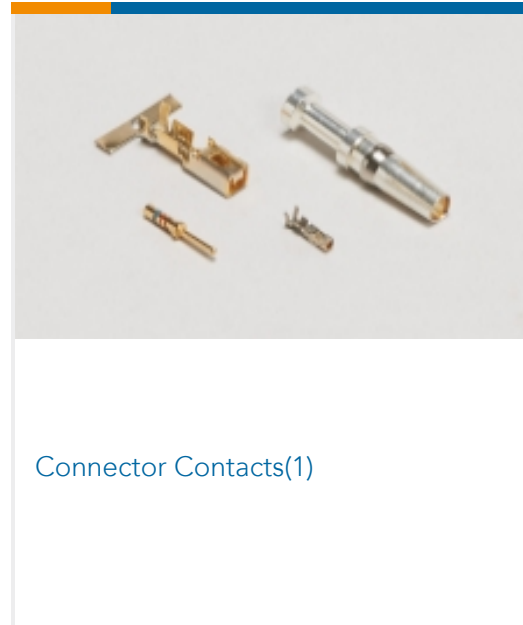

Customers Also Bought

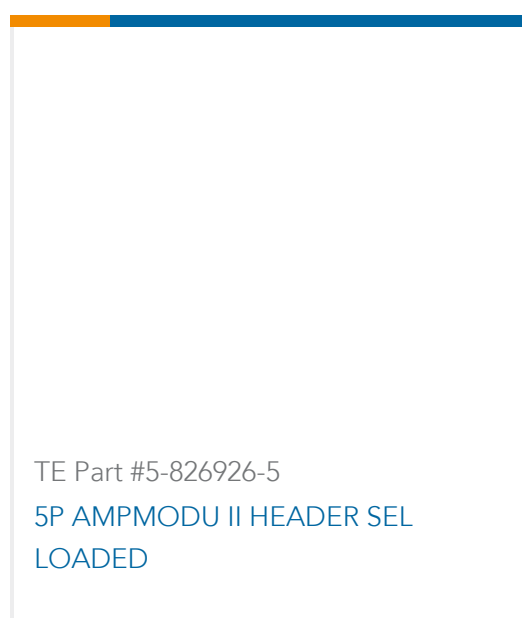
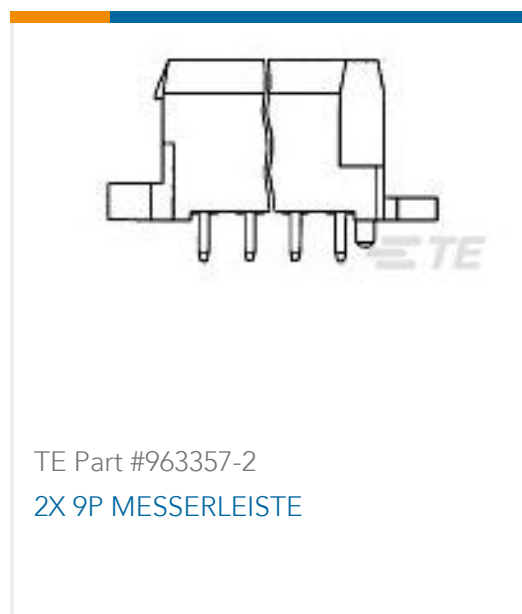

Documents

Product Drawings

[0.8mm Mini PCI-Express 9.9 Height](#)

English

CAD Files

[3D PDF](#)

3D

Customer View Model

[ENG_CVM_CVM_1759546-1_D.2d_dxf.zip](#)

English

Customer View Model

[ENG_CVM_CVM_1759546-1_D.3d_igs.zip](#)

English

Customer View Model

[ENG_CVM_CVM_1759546-1_D.3d_stp.zip](#)

English

By downloading the CAD file I accept and agree to the [Terms and Conditions](#) of use.

Datasheets & Catalog Pages



[8-1773459-7_EXPRESS_MINI_CARD_AND_DISPLAY_MINI_CARD_SOCKETS_QRG](#)

English

[Product Specifications](#)

[Product Specification](#)

English