

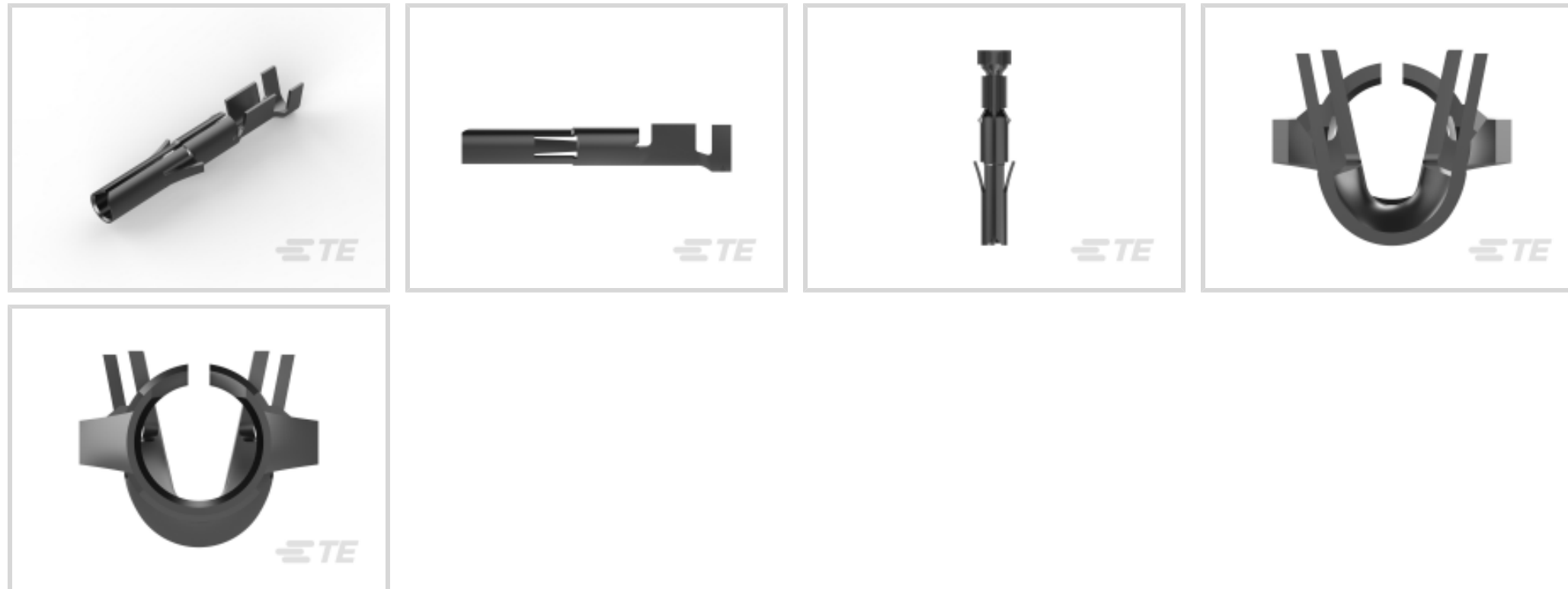

Connectors > Contacts > Connector Contacts



Contact Type: **Socket**

Contact Mating Area Plating Material: **Tin**

Wire Contact Termination Area Plating Material: **Pre-Tin**

Operating Voltage: **600 VAC**

Contact Retention Within Housing: **With**

Features

Product Type Features

Discrete Wire Type	Stranded
--------------------	----------

Electrical Characteristics

Operating Voltage	600 VAC
-------------------	---------

Contact Features

Mating Pin Diameter	2.13 mm [.084 in]
Wire Contact Termination Area Plating Thickness	.4 – 2 μm [15.74 – 78.74 μin]
Wire Contact Termination Area Plating Material Finish	Matte
Contact Orientation	Straight
Contact Type	Socket
Contact Mating Area Plating Material	Tin
Wire Contact Termination Area Plating Material	Pre-Tin
Contact Retention Within Housing	With
Contact Base Material	Phosphor Bronze
Contact Current Rating (Max)	19 A



Termination Features

Termination Method to Wire & Cable	Crimp
Product Terminates To	Wire & Cable

Mechanical Attachment

Wire Insulation Support	Without
Contact Retention Type Within Housing	Locking Lance

Dimensions

Compatible Insulation Diameter Range	1.02 – 2.54 mm [.04 – .1 in]
Wire Size	.2 – .82 mm ²

Usage Conditions

Operating Temperature Range	-55 – 105 °C [-67 – 221 °F]
-----------------------------	-----------------------------

Operation/Application

Circuit Application	Power
---------------------	-------

Industry Standards

Compatible With Agency/Standards Products	CSA, UL, VDE
---	--------------

Packaging Features

Packaging Quantity	7500
Packaging Method	Reel

Product Compliance

[For compliance documentation, visit the product page on TE.com>](#)

EU RoHS Directive 2011/65/EU	Compliant
EU ELV Directive 2000/53/EC	Compliant
China RoHS 2 Directive MIIT Order No 32, 2016	No Restricted Materials Above Threshold
EU REACH Regulation (EC) No. 1907/2006	Current ECHA Candidate List: JUNE 2024 (241) Candidate List Declared Against: JUNE 2024 (241) Does not contain REACH SVHC
Halogen Content	Low Halogen - Br, Cl, F, I < 900 ppm per homogenous material. Also BFR/CFR/PVC Free
Solder Process Capability	Not applicable for solder process capability

Product Compliance Disclaimer

This information is provided based on reasonable inquiry of our suppliers and represents our current actual knowledge based on the information they provided. This information is subject to change. The part numbers that TE has identified as EU RoHS compliant have a maximum concentration of 0.1% by weight in homogenous materials for lead, hexavalent chromium, mercury, PBB, PBDE, DBP, BBP, DEHP, DIBP, and 0.01% for cadmium, or qualify for an exemption to these limits as defined in the Annexes of Directive 2011/65/EU (RoHS2). Finished electrical and electronic equipment products will be CE marked as required by Directive 2011/65/EU. Components may not be CE marked. Additionally, the part numbers that TE has identified as EU ELV compliant have a maximum concentration of 0.1% by weight in homogenous materials for lead, hexavalent chromium, and mercury, and 0.01% for cadmium, or qualify for an exemption to these limits as defined in the Annexes of Directive 2000/53/EC (ELV). Regarding the REACH Regulation, the information TE provides on SVHC in articles for this part number is based on the latest European Chemicals Agency (ECHA) 'Guidance on requirements for substances in articles' posted at this URL: <https://echa.europa.eu/guidance-documents/guidance-on-reach>

Compatible Parts



TE Part # 2151019-1
OCEAN_2.0_Applicator-S-070F100F-RSM



TE Part # 91510-1
CCII UNML UNML II PIN SKT 24-18 ASSY



TE Part # 90548-2
PROCRIMPER DIE ASSY UNIV MNL



TE Part # 1804030-1
EXTRACTION TOOL ASSY



TE Part # 455830-1
INSERTION TOOL



TE Part # 1-480705-2
06P UNML CAP HSG RED



TE Part # 1-480708-9
12P UNML PLUG HSG BLK



TE Part # 350784-1
15P UNML CAP HSG



TE Part # 926307-3
6P UN-MNL AUFN-GEH



TE Part # 1-480704-2
06P UNML PLUG HSG RED



TE Part # 1-350777-2
02P UNML V0 PLUG HSG RED



TE Part # 350783-1
12P UNML CAP HSG



TE Part # 1-350778-9
02P UNML V0 CAP HSG BLACK



TE Part # 350735-1
12P UNML PLUG HSG



TE Part # 926302-3
10P UN-MNL STECKGEH



TE Part # 926308-3
8P UN-MNL AUFN-GEH



Also in the Series | Universal MATE-N-LOK

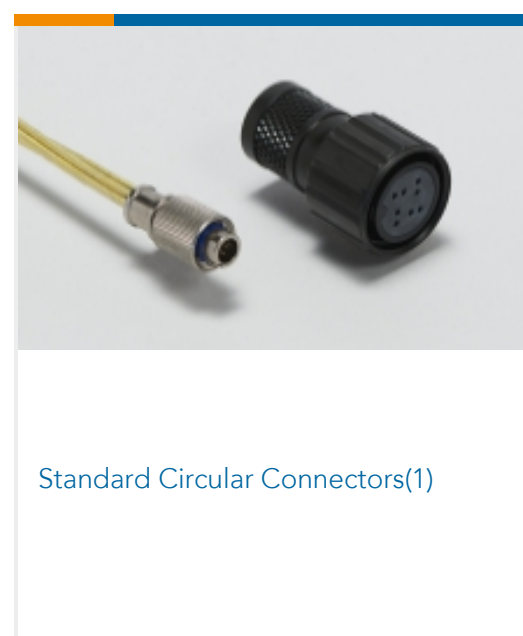
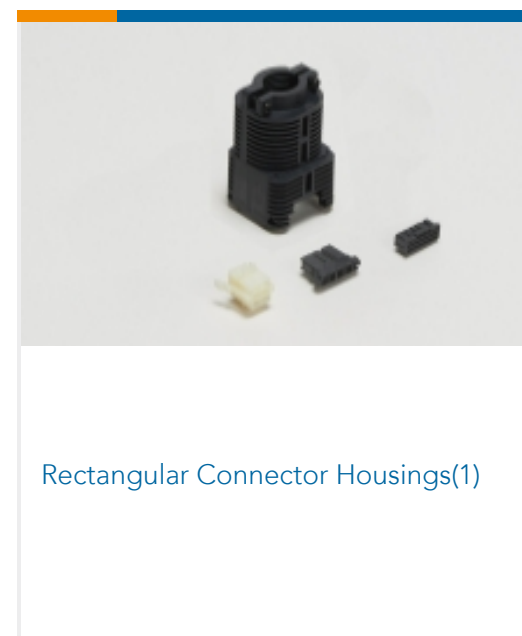
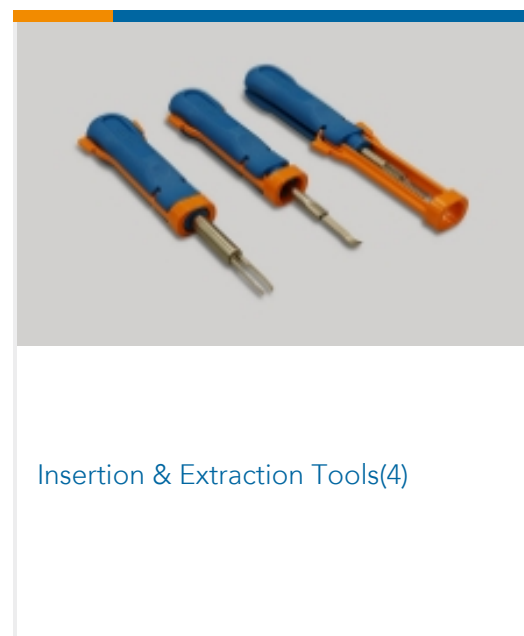
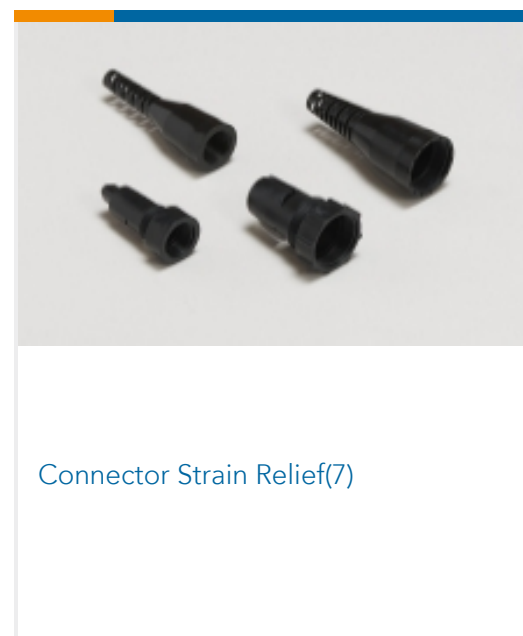
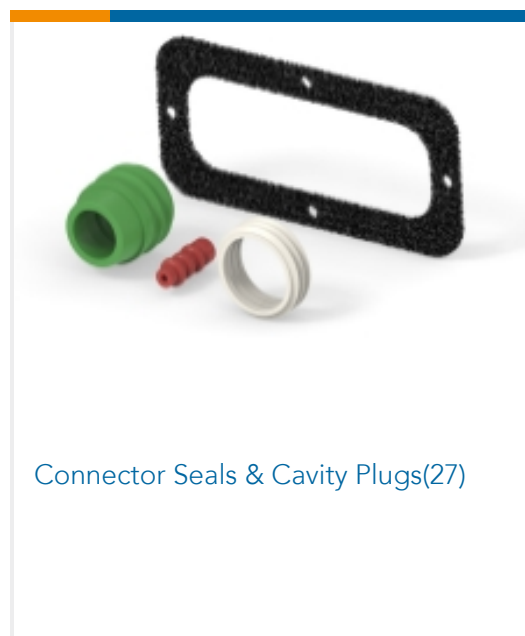
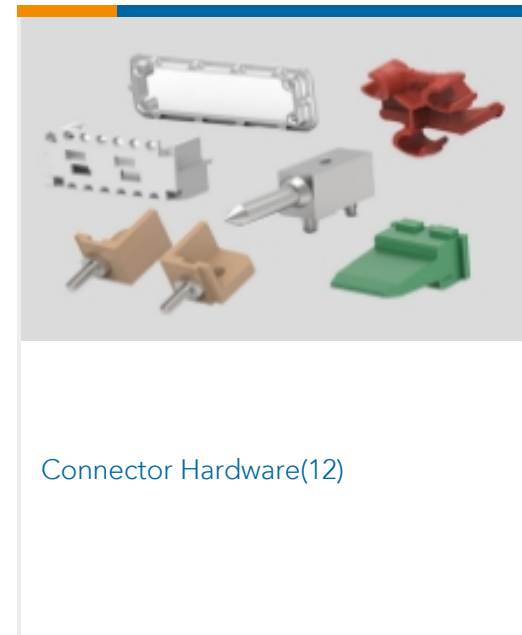
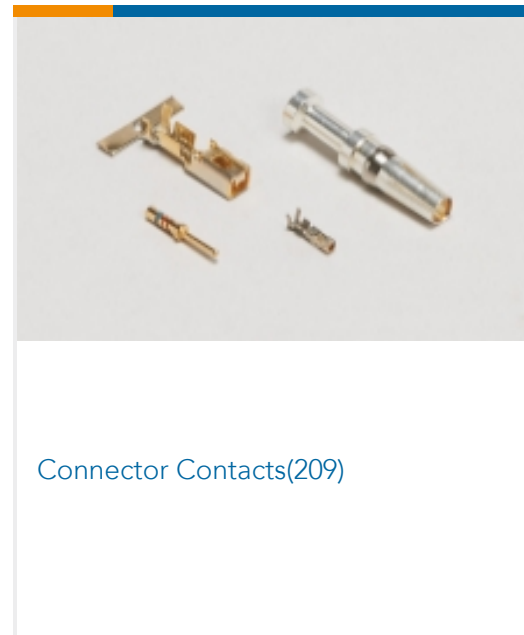
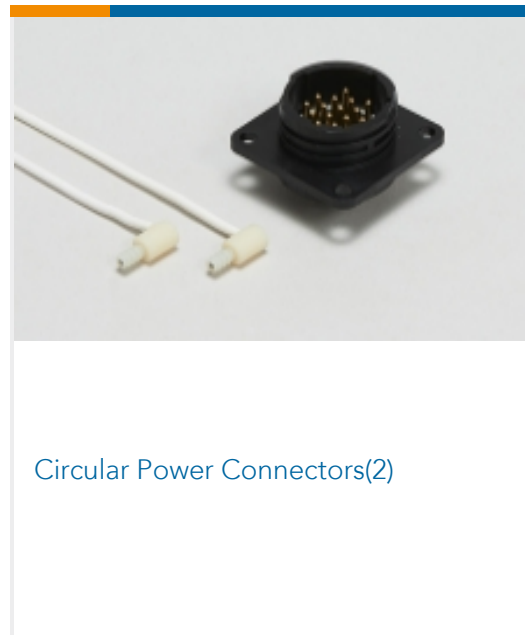

Customers Also Bought

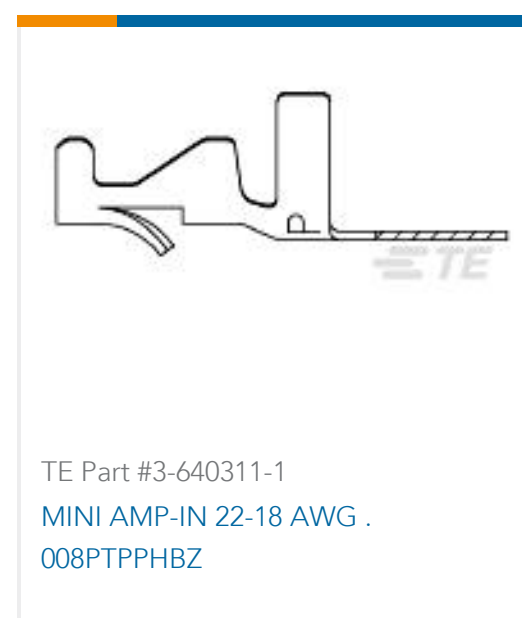
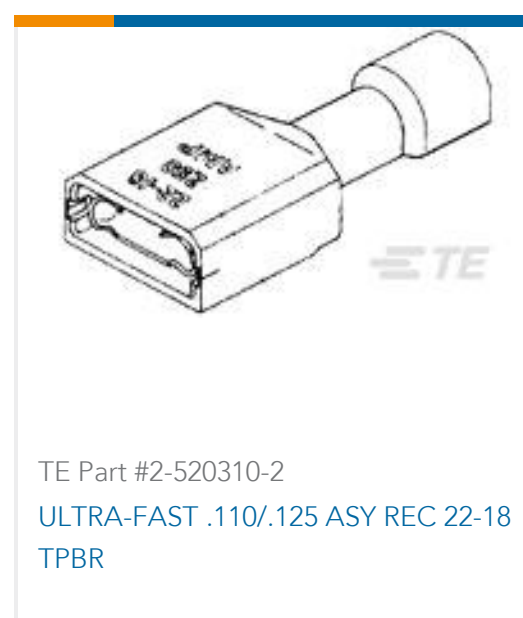

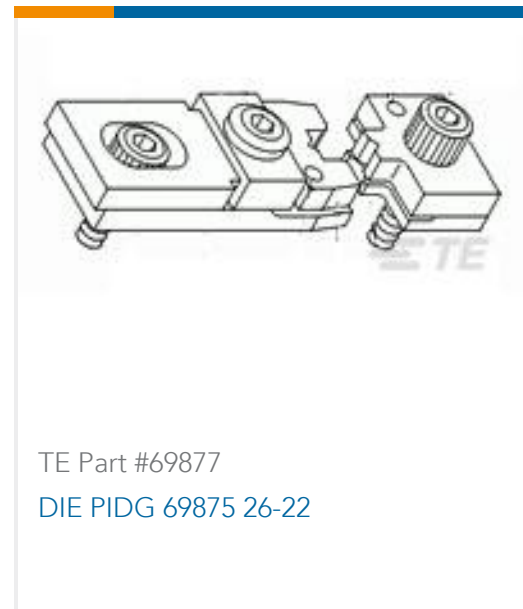

Documents

Product Drawings

CAD Files

[3D PDF](#)

3D

Customer View Model

[ENG_CVM_CVM_350570-3_AY.2d_dxf.zip](#)

English

Customer View Model

[ENG_CVM_CVM_350570-3_AY.3d_igs.zip](#)

English

Customer View Model

[ENG_CVM_CVM_350570-3_AY.3d_stp.zip](#)

English

By downloading the CAD file I accept and agree to the [Terms and Conditions](#) of use.

Datasheets & Catalog Pages

[SOFT_SHELL_PIN_SOCKET_CONNECTORS_STANDARD_DENSITY](#)

English

Product Specifications

[Engineering Report](#)

English

Agency Approvals

[UL](#)

English