

770834-1 ✓ ACTIVE

MATE-N-LOK | Mini-Universal MATE-N-LOK

TE Internal #: 770834-1

Socket Contact, Tin, 600 VAC, 600 VDC, 30 – 26 AWG Wire Size, .05 – .15 mm² Wire Size, Crimp, Brass, Power, Mini-Universal MATE-N-LOK

[View on TE.com >](#)



Connectors > Contacts > Connector Contacts



Contact Type: **Socket**

Contact Mating Area Plating Material: **Tin**

Wire Contact Termination Area Plating Material: **Pre-Tin**

Operating Voltage: **600 VDC**

Features

Product Type Features

Discrete Wire Type	Stranded
--------------------	----------

Electrical Characteristics

Operating Voltage	600 VDC
-------------------	---------

Contact Features

Mating Pin Diameter	1 mm [.039 in]
---------------------	----------------

Wire Contact Termination Area Plating Thickness	.4 μm [15.74 μin]
---	-------------------

Wire Contact Termination Area Plating Material Finish	Matte
---	-------

Contact Orientation	Straight
---------------------	----------

Contact Type	Socket
--------------	--------

Contact Mating Area Plating Material	Tin
--------------------------------------	-----

Wire Contact Termination Area Plating Material	Pre-Tin
--	---------

Contact Retention Within Housing	With
----------------------------------	------

Contact Base Material	Brass
-----------------------	-------

Contact Current Rating (Max)	11.2 A
------------------------------	--------



Termination Features

Termination Method to Wire & Cable	Crimp
Product Terminates To	Wire & Cable

Mechanical Attachment

Wire Insulation Support	Without
-------------------------	---------

Dimensions

Compatible Insulation Diameter Range	.89 – 1.27 mm [.035 – .05 in]
Wire Size	.05 – .15 mm ²

Usage Conditions

Operating Temperature Range	-55 – 105 °C [-67 – 221 °F]
-----------------------------	-----------------------------

Operation/Application

Circuit Application	Power
---------------------	-------

Industry Standards

Compatible With Agency/Standards Products	CSA, UL
UL Flammability Rating	UL 94V-0

Packaging Features

Packaging Quantity	10000
Packaging Method	Reel

Product Compliance

[For compliance documentation, visit the product page on TE.com>](#)

EU RoHS Directive 2011/65/EU	Compliant
EU ELV Directive 2000/53/EC	Compliant
China RoHS 2 Directive MIIT Order No 32, 2016	No Restricted Materials Above Threshold
EU REACH Regulation (EC) No. 1907/2006	Current ECHA Candidate List: JUNE 2024 (241) Candidate List Declared Against: JUNE 2024 (241) Does not contain REACH SVHC
Halogen Content	Low Halogen - Br, Cl, F, I < 900 ppm per homogenous material. Also BFR/CFR/PVC Free
Solder Process Capability	Not applicable for solder process capability

Product Compliance Disclaimer

This information is provided based on reasonable inquiry of our suppliers and represents our current actual knowledge based on the information they provided. This information is subject to change. The part numbers that TE has identified as EU RoHS compliant have a maximum concentration of 0.1% by weight in homogenous materials for lead, hexavalent chromium, mercury, PBB, PBDE, DBP, BBP, DEHP, DIBP, and 0.01% for cadmium, or qualify for an exemption to these limits as defined in the Annexes of Directive 2011/65/EU (RoHS2). Finished electrical and electronic equipment products will be CE marked as required by Directive 2011/65/EU. Components may not be CE marked. Additionally, the part numbers that TE has identified as EU ELV compliant have a maximum concentration of 0.1% by weight in homogenous materials for lead, hexavalent chromium, and mercury, and 0.01% for cadmium, or qualify for an exemption to these limits as defined in the Annexes of Directive 2000/53/EC (ELV). Regarding the REACH Regulation, the information TE provides on SVHC in articles for this part number is based on the latest European Chemicals Agency (ECHA) 'Guidance on requirements for substances in articles' posted at this URL: <https://echa.europa.eu/guidance-documents/guidance-on-reach>

Compatible Parts





Also in the Series | Mini-Universal MATE-N-LOK

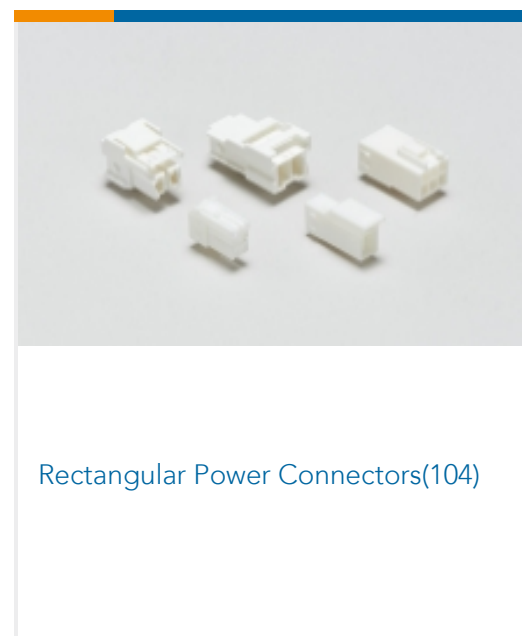
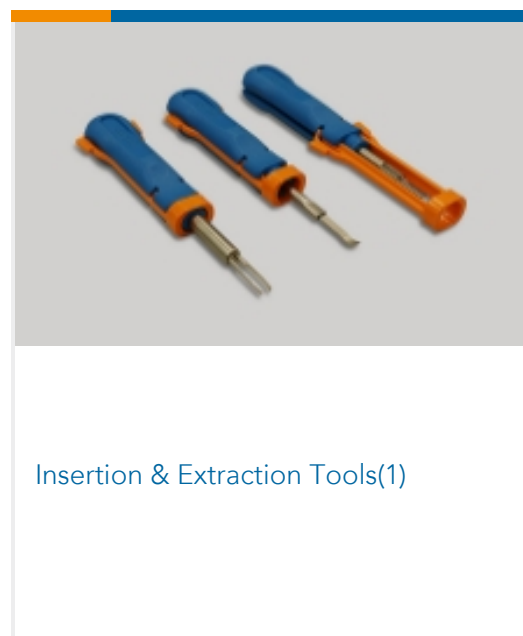
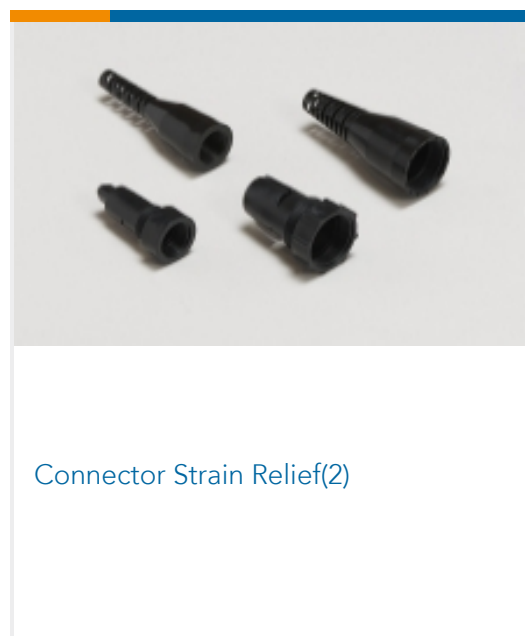
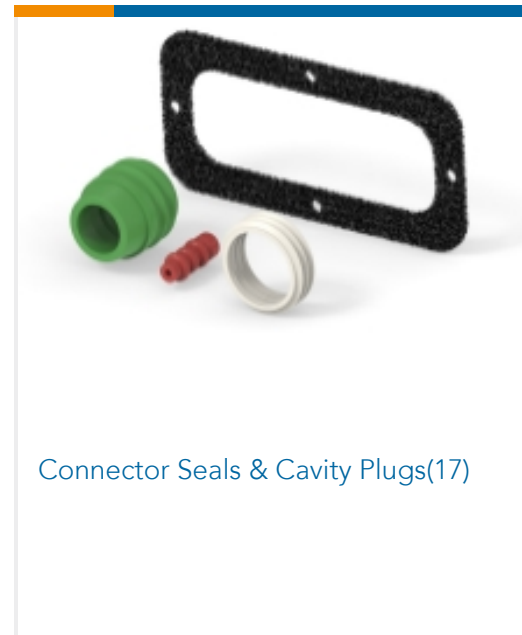
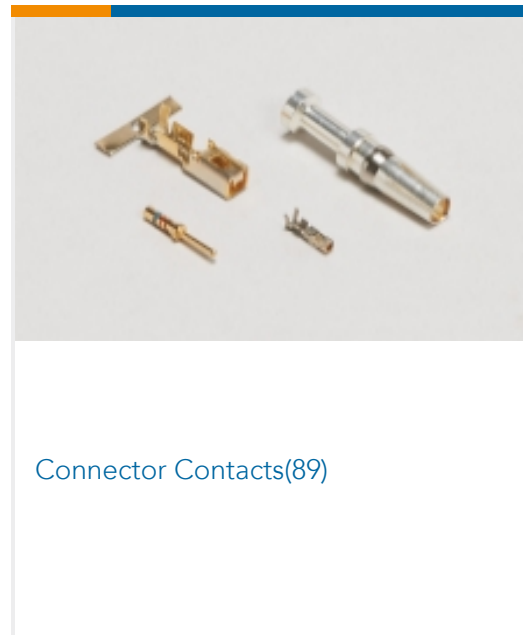
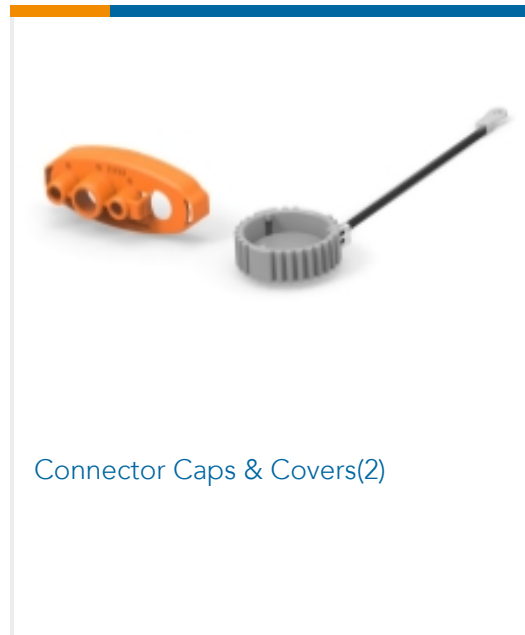

Customers Also Bought

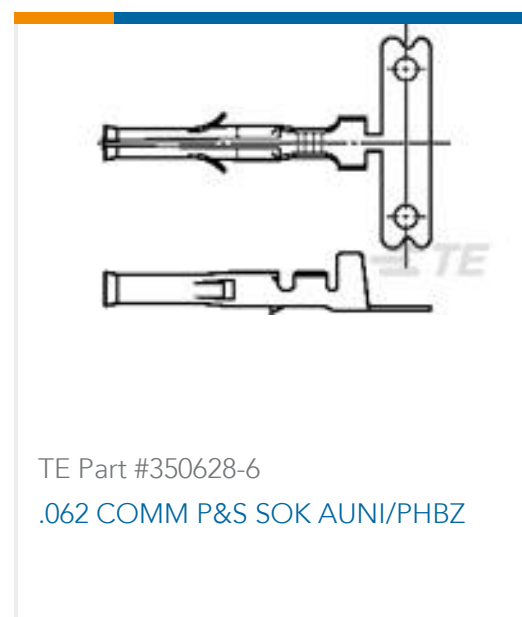



Documents

CAD Files

3D PDF

3D

Customer View Model

[ENG_CVM_CVM_770834-1_V.2d_dxf.zip](#)

English

Customer View Model

[ENG_CVM_CVM_770834-1_V.3d_igs.zip](#)

English

Customer View Model

[ENG_CVM_CVM_770834-1_V.3d_stp.zip](#)

English

Customer View Model

[ENG_CVM_770834-1_P.3d_igs.zip](#)

English

Customer View Model

[ENG_CVM_770834-1_P.3d_stp.zip](#)

English

Customer View Model

[ENG_CVM_770834-1_P.2d_dxf.zip](#)

English

3D PDF

English

By downloading the CAD file I accept and agree to the [Terms and Conditions](#) of use.

Datasheets & Catalog Pages

[AMP Circular Connectors for Commercial Signal & Power Applications Continued](#)

English

[SOFT_SHELL_PIN_AND_SOCKET_CONNECTORS_CATALOG](#)

English

Product Specifications

[Application Specification](#)

English

Instruction Sheets

[Instruction Sheet \(U.S.\)](#)

English

Agency Approvals

[Agency Approval Document](#)

English