

# 74AVC1T1004

1-to-4 fan-out buffer

Rev. 2 — 1 March 2021

Product data sheet

## 1. General description

The 74AVC1T1004 is a translating 1-to-4 fan-out buffer suitable for use in clock distribution. It has dual supplies ( $V_{CC(A)}$  and  $V_{CC(B)}$ ) for voltage translation. It also has a data input (A), four data outputs (Yn) and an output enable input ( $\overline{OE}$ ).  $V_{CC(A)}$  and  $V_{CC(B)}$  can be independently supplied at any voltage between 0.8 V and 3.6 V. It makes the device suitable for low voltage translation between any of the following voltages: 0.8 V, 1.2 V, 1.5 V, 1.8 V, 2.5 V and 3.3 V. The levels of A and  $\overline{OE}$  are referenced to  $V_{CC(A)}$ , outputs Yn are referenced to  $V_{CC(B)}$ . This supply configuration ensures that the fanned out signals can be used in level shifting. A HIGH on  $\overline{OE}$  causes all outputs to be pulled LOW via pull-down resistors, a LOW on  $\overline{OE}$  disconnects the pull-down resistors and enables all outputs.

Schmitt trigger action at all inputs makes the circuit tolerant for slower input rise and fall time.

The  $I_{OFF}$  circuitry disables the output, preventing any damaging backflow current through the device when it is powered down.

## 2. Features and benefits

- Wide supply voltage range:
  - $V_{CC(A)}$ : 0.8 V to 3.6 V
  - $V_{CC(B)}$ : 0.8 V to 3.6 V
- Complies with JEDEC standards:
  - JESD8-12 (0.8 V to 1.3 V)
  - JESD8-11 (0.9 V to 1.65 V)
  - JESD8-7 (1.2 V to 1.95 V)
  - JESD8-5 (1.8 V to 2.7 V)
  - JESD8-B (2.7 V to 3.6 V)
- ESD protection:
  - HBM ANSI/ESDA/JEDEC JS-001 Class 2 exceeds 2 kV
  - CDM JESD22-C101 exceeds 1 kV
- Maximum data rates:
  - 380 Mbit/s ( $\geq 1.8$  V to 3.3 V translation)
  - 200 Mbit/s ( $\geq 1.1$  V to 3.3 V translation)
  - 200 Mbit/s ( $\geq 1.1$  V to 2.5 V translation)
  - 200 Mbit/s ( $\geq 1.1$  V to 1.8 V translation)
  - 150 Mbit/s ( $\geq 1.1$  V to 1.5 V translation)
  - 100 Mbit/s ( $\geq 1.1$  V to 1.2 V translation)
- Latch-up performance exceeds 100 mA per JESD 78 Class II
- Inputs accept voltages up to 3.6 V
- Specified from -40 °C to +85 °C and -40 °C to +125 °C



## 6. Pinning information

### 6.1. Pinning

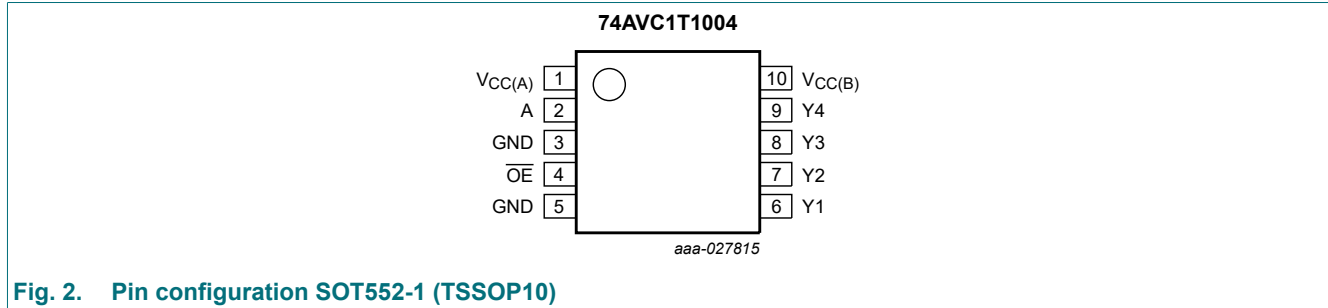

Fig. 2. Pin configuration SOT552-1 (TSSOP10)

### 6.2. Pin description

Table 3. Pin description

Symbol	Pin	Description
$V_{CC(A)}$	1	supply voltage A
A	2	data input (referenced to $V_{CC(A)}$ )
GND[1]	3, 5	ground (0 V)
$\overline{OE}$	4	output enable input (active LOW) (referenced to $V_{CC(A)}$ )
Y1, Y2, Y3, Y4	6, 7, 8, 9	data outputs (referenced to $V_{CC(B)}$ )
$V_{CC(B)}$	10	supply voltage B

[1] All GND pins must be connected to ground (0 V).

## 7. Functional description

Table 4. Function table

H = HIGH voltage level; L = LOW voltage level; X = don't care.

Inputs		Output
OE	A	Yn
L	L	L
L	H	H
H	X	L

## 8. Limiting values

**Table 5. Limiting values**

In accordance with the Absolute Maximum Rating System (IEC 60134). Voltages are referenced to GND (ground = 0 V).

Symbol	Parameter	Conditions	Min	Max	Unit
$V_{CC(A)}$	supply voltage A		-0.5	+4.6	V
$V_{CC(B)}$	supply voltage B		-0.5	+4.6	V
$V_I$	input voltage		-0.5	+4.6	V
$V_O$	output voltage	$\overline{OE} = \text{LOW}$	-0.5	$V_{CC(B)} + 0.5$	V
		$\overline{OE} = \text{HIGH}$	-0.5	+4.6	V
$I_{IK}$	input clamping current	$V_I < 0 \text{ V}$	-50	-	mA
$I_{OK}$	output clamping current	$V_O < 0 \text{ V}$	-50	-	mA
$I_O$	output current	$V_O = 0 \text{ V to } V_{CC(B)}$	-	$\pm 50$	mA
$I_{CC}$	supply current	$I_{CC(A)}$ or $I_{CC(B)}$	-	100	mA
$I_{GND}$	ground current		-100	-	mA
$T_{stg}$	storage temperature		-65	+150	°C
$P_{tot}$	total power dissipation	$T_{amb} = -40 \text{ °C to } +125 \text{ °C}$	-	250	mW

[1] The minimum input voltage ratings and output voltage ratings may be exceeded if the input and output current ratings are observed.

[2]  $V_{CC(B)} + 0.5 \text{ V}$  should not exceed 4.6 V.

[3] For SOT552-1 (TSSOP10) packages:  $P_{tot}$  derates linearly with 8.3 mW/K above 120 °C.

## 9. Recommended operating conditions

**Table 6. Recommended operating conditions**

Symbol	Parameter	Conditions	Min	Max	Unit
$V_{CC(A)}$	supply voltage A		0.8	3.6	V
$V_{CC(B)}$	supply voltage B		0.8	3.6	V
$V_I$	input voltage		0	3.6	V
$V_O$	output voltage	$\overline{OE} = \text{LOW}$	0	$V_{CC(B)}$	V
		$\overline{OE} = \text{HIGH}$	0	3.6	V
$T_{amb}$	ambient temperature		-40	+125	°C
$\Delta t/\Delta V$	input transition rise and fall rate	$V_{CC(A)} = 0.8 \text{ V to } 3.6 \text{ V}$	0	200	ns/V

## 10. Static characteristics

**Table 7. Static characteristics**

At recommended operating conditions; voltages are referenced to GND (ground = 0 V).

Symbol	Parameter	Conditions	T <sub>amb</sub> = 25 °C			Unit
			Min	Typ	Max	
V <sub>OH</sub>	HIGH-level output voltage	V <sub>I</sub> = V <sub>IH</sub> or V <sub>IL</sub>				
		I <sub>O</sub> = -1.5 mA; V <sub>CC(B)</sub> = 0.8 V	-	0.69	-	V
V <sub>OL</sub>	LOW-level output voltage	V <sub>I</sub> = V <sub>IH</sub> or V <sub>IL</sub>				
		I <sub>O</sub> = 1.5 mA; V <sub>CC(B)</sub> = 0.8 V	-	0.07	-	V
I <sub>I</sub>	input leakage current	A, $\overline{OE}$ input; V <sub>I</sub> = 0 V or 3.6 V; V <sub>CC(A)</sub> = V <sub>CC(B)</sub> = 0.8 V to 3.6 V	-	±0.025	±0.25	µA
I <sub>OFF</sub>	power-off leakage current	V <sub>I</sub> or V <sub>O</sub> = 0 V to 3.6 V; V <sub>CC(A)</sub> or V <sub>CC(B)</sub> = 0 V	-	±0.1	±1	µA
R <sub>pd</sub>	pull-down resistance		-	50	-	kΩ
C <sub>I</sub>	input capacitance	A, $\overline{OE}$ input; V <sub>I</sub> = 0 V or 3.3 V; V <sub>CC(A)</sub> = 3.3 V	-	1.2	-	pF
C <sub>O</sub>	output capacitance	Yn; V <sub>O</sub> = 3.3 V or 0 V; V <sub>CC(B)</sub> = 3.3 V	-	4.7	-	pF

**Table 8. Static characteristics**

At recommended operating conditions; voltages are referenced to GND (ground = 0 V).

Symbol	Parameter	Conditions	T <sub>amb</sub> = -40 °C to +85 °C		T <sub>amb</sub> = -40 °C to +125 °C		Unit
			Min	Max	Min	Max	
V <sub>IH</sub>	HIGH-level input voltage	A, $\overline{OE}$ input					
		V <sub>CC(A)</sub> = 0.8 V	0.70V <sub>CC(A)</sub>	-	0.70V <sub>CC(A)</sub>	-	V
		V <sub>CC(A)</sub> = 1.1 V to 1.95 V	0.65V <sub>CC(A)</sub>	-	0.65V <sub>CC(A)</sub>	-	V
		V <sub>CC(A)</sub> = 2.3 V to 2.7 V	1.6	-	1.6	-	V
		V <sub>CC(A)</sub> = 3.0 V to 3.6 V	2	-	2	-	V
V <sub>IL</sub>	LOW-level input voltage	A, $\overline{OE}$ input					
		V <sub>CC(A)</sub> = 0.8 V	-	0.30V <sub>CC(A)</sub>	-	0.30V <sub>CC(A)</sub>	V
		V <sub>CC(A)</sub> = 1.1 V to 1.95 V	-	0.35V <sub>CC(A)</sub>	-	0.35V <sub>CC(A)</sub>	V
		V <sub>CC(A)</sub> = 2.3 V to 2.7 V	-	0.7	-	0.7	V
		V <sub>CC(A)</sub> = 3.0 V to 3.6 V	-	0.8	-	0.8	V
V <sub>OH</sub>	HIGH-level output voltage	V <sub>I</sub> = V <sub>IH</sub> or V <sub>IL</sub>					
		I <sub>O</sub> = -100 µA; V <sub>CC(B)</sub> = 0.8 V to 3.6 V	V <sub>CC(B)</sub> - 0.1	-	V <sub>CC(B)</sub> - 0.1	-	V
		I <sub>O</sub> = -3 mA; V <sub>CC(B)</sub> = 1.1 V	0.85	-	0.85	-	V
		I <sub>O</sub> = -6 mA; V <sub>CC(B)</sub> = 1.4 V	1.05	-	1.05	-	V
		I <sub>O</sub> = -8 mA; V <sub>CC(B)</sub> = 1.65 V	1.2	-	1.2	-	V
		I <sub>O</sub> = -9 mA; V <sub>CC(B)</sub> = 2.3 V	1.75	-	1.75	-	V
		I <sub>O</sub> = -12 mA; V <sub>CC(B)</sub> = 3.0 V	2.3	-	2.3	-	V

Symbol	Parameter	Conditions	T <sub>amb</sub> = -40 °C to +85 °C		T <sub>amb</sub> = -40 °C to +125 °C		Unit
			Min	Max	Min	Max	
V <sub>OL</sub>	LOW-level output voltage	V <sub>I</sub> = V <sub>IH</sub> or V <sub>IL</sub>					
		I <sub>O</sub> = 100 μA; V <sub>CC(B)</sub> = 0.8 V to 3.6 V	-	0.1	-	0.1	V
		I <sub>O</sub> = 3 mA; V <sub>CC(B)</sub> = 1.1 V	-	0.25	-	0.25	V
		I <sub>O</sub> = 6 mA; V <sub>CC(B)</sub> = 1.4 V	-	0.35	-	0.35	V
		I <sub>O</sub> = 8 mA; V <sub>CC(B)</sub> = 1.65 V	-	0.45	-	0.45	V
		I <sub>O</sub> = 9 mA; V <sub>CC(B)</sub> = 2.3 V	-	0.55	-	0.55	V
		I <sub>O</sub> = 12 mA; V <sub>CC(B)</sub> = 3.0 V	-	0.7	-	0.7	V
I <sub>I</sub>	input leakage current	A, $\overline{OE}$ input; V <sub>I</sub> = 0 V or 3.6 V; V <sub>CC(A)</sub> = V <sub>CC(B)</sub> = 0.8 V to 3.6 V	-	±1	-	±5	μA
I <sub>OFF</sub>	power-off leakage current	V <sub>I</sub> or V <sub>O</sub> = 0 V to 3.6 V; V <sub>CC(B)</sub> = 0 V; V <sub>CC(A)</sub> = 0.8 V to 3.6 V	-	±5	-	±30	μA
I <sub>CC(A)</sub>	supply current A	V <sub>I</sub> = 0 V or V <sub>CC(A)</sub> ; I <sub>O</sub> = 0 A; V <sub>CC(A)</sub> = 0.8 V to 3.6 V; V <sub>CC(B)</sub> = 0.8 V to 3.6 V	-	8	-	50	μA
I <sub>CC(B)</sub>	supply current B	V <sub>I</sub> = 0 V or V <sub>CC(A)</sub> ; I <sub>O</sub> = 0 A; V <sub>CC(A)</sub> = 0.8 V to 3.6 V; V <sub>CC(B)</sub> = 0.8 V to 3.6 V	-	8	-	50	μA

## 11. Dynamic characteristics

**Table 9. Typical dynamic characteristics at V<sub>CC(A)</sub> = 0.8 V and T<sub>amb</sub> = 25 °C**

Voltages are referenced to GND (ground = 0 V); for test circuit, see Fig. 5; for waveforms, see Fig. 3 and Fig. 4.

Symbol [1]	Parameter	Conditions	V <sub>CC(B)</sub>						Unit
			0.8 V	1.2 V	1.5 V	1.8 V	2.5 V	3.3 V	
t <sub>pd</sub>	propagation delay	A to Yn	29	16	15	15	14	14	ns
t <sub>dis</sub>	disable time	$\overline{OE}$ to Yn	25	15	14	14	14	15	ns
t <sub>en</sub>	enable time	$\overline{OE}$ to Yn	33	18	16	16	15	15	ns

- [1] t<sub>pd</sub> is the same as t<sub>PLH</sub> and t<sub>P<sub>HL</sub></sub>;  
t<sub>dis</sub> is the same as t<sub>PLZ</sub> and t<sub>P<sub>HZ</sub></sub>;  
t<sub>en</sub> is the same as t<sub>P<sub>ZL</sub></sub> and t<sub>P<sub>ZH</sub></sub>.

**Table 10. Typical dynamic characteristics at V<sub>CC(B)</sub> = 0.8 V and T<sub>amb</sub> = 25 °C**

Voltages are referenced to GND (ground = 0 V); for test circuit, see Fig. 5; for waveforms, see Fig. 3 and Fig. 4.

Symbol [1]	Parameter	Conditions	V <sub>CC(A)</sub>						Unit
			0.8 V	1.2 V	1.5 V	1.8 V	2.5 V	3.3 V	
t <sub>pd</sub>	propagation delay	A to Yn	29	20	20	19	19	18	ns
t <sub>dis</sub>	disable time	$\overline{OE}$ to Yn	25	17	16	16	15	15	ns
t <sub>en</sub>	enable time	$\overline{OE}$ to Yn	33	24	23	23	22	22	ns

- [1] t<sub>pd</sub> is the same as t<sub>PLH</sub> and t<sub>P<sub>HL</sub></sub>;  
t<sub>dis</sub> is the same as t<sub>PLZ</sub> and t<sub>P<sub>HZ</sub></sub>;  
t<sub>en</sub> is the same as t<sub>P<sub>ZL</sub></sub> and t<sub>P<sub>ZH</sub></sub>.

Table 11. Dynamic characteristics for temperature range -40 °C to +85 °C

Voltages are referenced to GND (ground = 0 V); for test circuit, see Fig. 5; for waveforms, see Fig. 3 and Fig. 4.

Symbol [1]	Parameter	Conditions	$V_{CC(B)}$										Unit
			1.2 V ± 0.1 V		1.5 V ± 0.1 V		1.8 V ± 0.15 V		2.5 V ± 0.2 V		3.3 V ± 0.3 V		
			Min	Max	Min	Max	Min	Max	Min	Max	Min	Max	
<b><math>V_{CC(A)} = 1.1 \text{ V to } 1.3 \text{ V}</math></b>													
$t_{pd}$	propagation delay	A to Yn	0.9	14.7	0.8	11.2	0.7	9.9	0.6	8.8	0.6	8.5	ns
$t_{dis}$	disable time	$\overline{OE}$ to Yn	1.0	14.7	0.9	12.2	0.9	12.1	0.8	10.8	1.0	11.7	ns
$t_{en}$	enable time	$\overline{OE}$ to Yn	1.0	15.8	0.8	11.8	0.8	10.3	0.7	8.9	0.7	8.5	ns
<b><math>V_{CC(A)} = 1.4 \text{ V to } 1.6 \text{ V}</math></b>													
$t_{pd}$	propagation delay	A to Yn	0.8	13.2	0.7	9.5	0.6	8.2	0.5	6.7	0.5	6.2	ns
$t_{dis}$	disable time	$\overline{OE}$ to Yn	0.9	12.4	0.8	9.7	0.8	9.7	0.7	8.3	0.9	9.0	ns
$t_{en}$	enable time	$\overline{OE}$ to Yn	0.9	14.0	0.7	9.9	0.7	8.5	0.6	6.9	0.6	6.2	ns
<b><math>V_{CC(A)} = 1.65 \text{ V to } 1.95 \text{ V}</math></b>													
$t_{pd}$	propagation delay	A to Yn	0.8	12.5	0.7	8.9	0.6	7.6	0.5	6.1	0.5	5.4	ns
$t_{dis}$	disable time	$\overline{OE}$ to Yn	0.9	11.7	0.8	9.0	0.8	8.8	0.7	7.4	0.8	8.2	ns
$t_{en}$	enable time	$\overline{OE}$ to Yn	0.9	13.5	0.7	9.3	0.6	7.9	0.6	6.3	0.5	5.6	ns
<b><math>V_{CC(A)} = 2.3 \text{ V to } 2.7 \text{ V}</math></b>													
$t_{pd}$	propagation delay	A to Yn	0.8	12.0	0.6	8.3	0.6	6.9	0.5	5.4	0.4	4.7	ns
$t_{dis}$	disable time	$\overline{OE}$ to Yn	0.9	11.0	0.7	8.3	0.8	8.0	0.6	6.5	0.8	7.2	ns
$t_{en}$	enable time	$\overline{OE}$ to Yn	0.8	12.8	0.7	8.7	0.6	7.3	0.5	5.5	0.5	4.8	ns
<b><math>V_{CC(A)} = 3.0 \text{ V to } 3.6 \text{ V}</math></b>													
$t_{pd}$	propagation delay	A to Yn	0.8	11.6	0.6	8.0	0.5	6.5	0.5	5.1	0.4	4.4	ns
$t_{dis}$	disable time	$\overline{OE}$ to Yn	0.9	10.8	0.7	8.0	0.7	7.7	0.6	6.2	0.7	6.9	ns
$t_{en}$	enable time	$\overline{OE}$ to Yn	0.8	12.5	0.6	8.4	0.6	6.9	0.5	5.2	0.5	4.5	ns

- [1]  $t_{pd}$  is the same as  $t_{PLH}$  and  $t_{PHL}$ ;  
 $t_{dis}$  is the same as  $t_{PLZ}$  and  $t_{PHZ}$ ;  
 $t_{en}$  is the same as  $t_{PZL}$  and  $t_{PZH}$ .

Table 12. Dynamic characteristics for temperature range -40 °C to +125 °C

Voltages are referenced to GND (ground = 0 V); for test circuit, see Fig. 5; for waveforms, see Fig. 3 and Fig. 4.

Symbol [1]	Parameter	Conditions	$V_{CC(B)}$										Unit
			1.2 V $\pm$ 0.1 V		1.5 V $\pm$ 0.1 V		1.8 V $\pm$ 0.15 V		2.5 V $\pm$ 0.2 V		3.3 V $\pm$ 0.3 V		
			Min	Max	Min	Max	Min	Max	Min	Max	Min	Max	
<b><math>V_{CC(A)} = 1.1 \text{ V to } 1.3 \text{ V}</math></b>													
$t_{pd}$	propagation delay	A to Yn	0.9	15.7	0.8	12.1	0.7	10.8	0.6	9.7	0.6	9.3	ns
$t_{dis}$	disable time	$\overline{OE}$ to Yn	1.0	16.5	0.9	13.8	0.9	13.7	0.8	12.3	1.0	13.1	ns
$t_{en}$	enable time	$\overline{OE}$ to Yn	1.0	16.9	0.8	12.9	0.8	11.4	0.7	9.7	0.7	9.2	ns
<b><math>V_{CC(A)} = 1.4 \text{ V to } 1.6 \text{ V}</math></b>													
$t_{pd}$	propagation delay	A to Yn	0.8	14.1	0.7	10.4	0.6	9.0	0.5	7.3	0.5	6.8	ns
$t_{dis}$	disable time	$\overline{OE}$ to Yn	0.9	14.0	0.8	11.0	0.8	11.0	0.7	9.5	0.9	10.2	ns
$t_{en}$	enable time	$\overline{OE}$ to Yn	0.9	15.1	0.7	10.9	0.7	9.3	0.6	7.6	0.6	6.8	ns
<b><math>V_{CC(A)} = 1.65 \text{ V to } 1.95 \text{ V}</math></b>													
$t_{pd}$	propagation delay	A to Yn	0.8	13.6	0.7	9.7	0.6	8.3	0.5	6.7	0.5	6.0	ns
$t_{dis}$	disable time	$\overline{OE}$ to Yn	0.9	13.4	0.8	10.2	0.8	10.0	0.7	8.4	0.8	9.2	ns
$t_{en}$	enable time	$\overline{OE}$ to Yn	0.9	14.5	0.7	10.2	0.6	8.7	0.6	6.9	0.5	6.2	ns
<b><math>V_{CC(A)} = 2.3 \text{ V to } 2.7 \text{ V}</math></b>													
$t_{pd}$	propagation delay	A to Yn	0.8	12.9	0.6	9.1	0.6	7.6	0.5	5.9	0.4	5.2	ns
$t_{dis}$	disable time	$\overline{OE}$ to Yn	0.9	12.5	0.7	9.4	0.8	9.1	0.6	7.5	0.8	8.2	ns
$t_{en}$	enable time	$\overline{OE}$ to Yn	0.8	13.7	0.7	9.5	0.6	8.0	0.5	6.1	0.5	5.3	ns
<b><math>V_{CC(A)} = 3.0 \text{ V to } 3.6 \text{ V}</math></b>													
$t_{pd}$	propagation delay	A to Yn	0.8	12.5	0.6	8.7	0.5	7.2	0.5	5.6	0.4	4.9	ns
$t_{dis}$	disable time	$\overline{OE}$ to Yn	0.9	12.1	0.7	9.1	0.7	8.8	0.6	7.1	0.7	7.7	ns
$t_{en}$	enable time	$\overline{OE}$ to Yn	0.8	13.4	0.6	9.2	0.6	7.6	0.5	5.7	0.5	4.9	ns

- [1]  $t_{pd}$  is the same as  $t_{PLH}$  and  $t_{PHL}$ ;  
 $t_{dis}$  is the same as  $t_{PLZ}$  and  $t_{PHZ}$ ;  
 $t_{en}$  is the same as  $t_{PZL}$  and  $t_{PZH}$ .

**Table 13. Dynamic characteristics for temperature range -40 °C to +85 °C and -40 °C to +125 °C**

Voltages are referenced to GND (ground = 0 V); for test circuit, see Fig. 5.

Symbol	Parameter	Conditions	$V_{CC(A)} = V_{CC(B)}$					Unit
			1.2 V ± 0.1 V	1.5 V ± 0.1 V	1.8 V ± 0.15 V	2.5 V ± 0.2 V	3.3 V ± 0.3 V	
			Max	Max	Max	Max	Max	
<b><math>T_{amb} = -40\text{ °C to }+85\text{ °C}</math></b>								
$t_{sk(o)}$	output skew time	between any output	0.7	0.4	0.3	0.2	0.2	ns
<b><math>T_{amb} = -40\text{ °C to }+125\text{ °C}</math></b>								
$t_{sk(o)}$	output skew time	between any output	0.9	0.5	0.4	0.3	0.2	ns

**Table 14. Typical power dissipation capacitance at  $T_{amb} = 25\text{ °C}$**

Symbol [1] [2]	Parameter	Conditions	$V_{CC(A)} = V_{CC(B)}$						Unit
			0.8 V	1.2 V	1.5 V	1.8 V	2.5 V	3.3 V	
$C_{PD}$	power dissipation capacitance	Yn; outputs enabled	36	36	37	37	41	46	pF
		Yn; outputs disabled	2.9	3.2	3.4	3.5	3.7	3.9	pF

[1]  $C_{PD}$  is used to determine the dynamic power dissipation ( $P_D$  in  $\mu W$ ).

$$P_D = C_{PD} \times V_{CC}^2 \times f_i + \sum(C_L \times V_{CC}^2 \times f_o) \text{ where:}$$

$f_i$  = input frequency in MHz;

$f_o$  = output frequency in MHz;

$C_L$  = load capacitance in pF;

$V_{CC}$  = supply voltage in V;

$\sum(C_L \times V_{CC}^2 \times f_o)$  = sum of the outputs.

[2]  $f_i = 10\text{ MHz}$ ;

$V_I = \text{GND to } V_{CC(A)}$ ;

$t_r = t_f = 1\text{ ns}$ ;

$C_L = 0\text{ pF}$ ;

$R_L = \infty\ \Omega$ .

11.1. Waveforms and test circuit

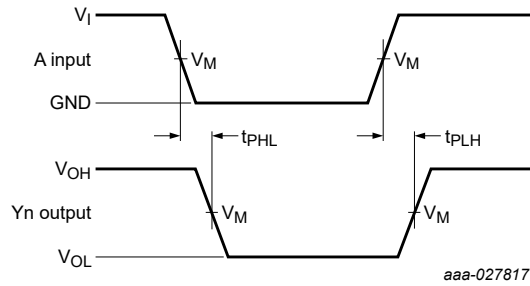

Measurement points are given in [Table 15](#).

$V_{OL}$  and  $V_{OH}$  are typical output voltage levels that occur with the output load.

**Fig. 3. The data input (A) to output (Yn) propagation delay times**

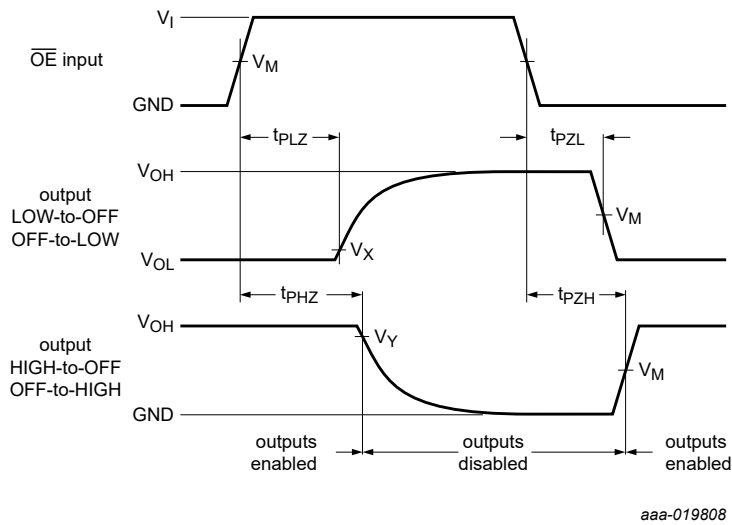

Measurement points are given in [Table 15](#).

$V_{OL}$  and  $V_{OH}$  are typical output voltage levels that occur with the output load.

**Fig. 4. Enable and disable times**

**Table 15. Measurement points**

Supply voltage	Input	Output		
$V_{CC(A)}, V_{CC(B)}$	$V_M$	$V_M$	$V_X$	$V_Y$
0.8 V to 1.6 V	$0.5V_{CC(A)}$	$0.5V_{CC(B)}$	$V_{OL} + 0.1\text{ V}$	$V_{OH} - 0.1\text{ V}$
1.65 V to 2.7 V	$0.5V_{CC(A)}$	$0.5V_{CC(B)}$	$V_{OL} + 0.15\text{ V}$	$V_{OH} - 0.15\text{ V}$
3.0 V to 3.6 V	$0.5V_{CC(A)}$	$0.5V_{CC(B)}$	$V_{OL} + 0.3\text{ V}$	$V_{OH} - 0.3\text{ V}$

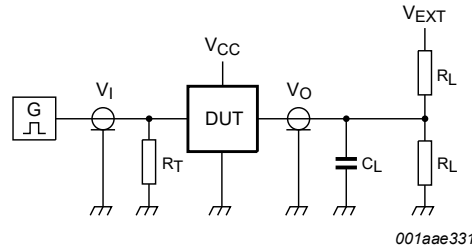
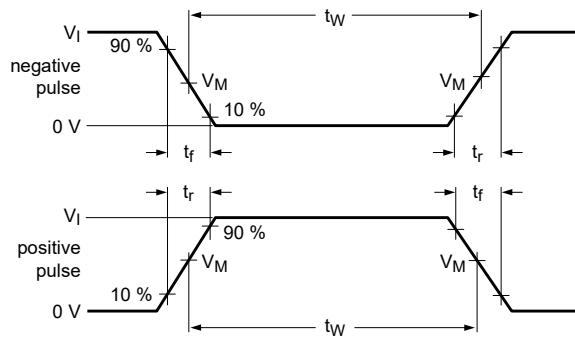

001aae331

Test data is given in [Table 16](#)

$R_L$  = Load resistance.

$C_L$  = Load capacitance including jig and probe capacitance.

$R_T$  = Termination resistance.

$V_{EXT}$  = External voltage for measuring switching times.

**Fig. 5. Test circuit for measuring switching times**

**Table 16. Test data**

Supply voltage	Input		Load		$V_{EXT}$		
$V_{CC(A)}, V_{CC(B)}$	$V_I$	$\Delta t/\Delta V$ [1]	$C_L$	$R_L$	$t_{PLH}, t_{PHL}$	$t_{PZH}, t_{PHZ}$	$t_{PZL}, t_{PLZ}$
0.8 V to 1.6 V	$V_{CC(A)}$	$\leq 1.0$ ns/V	15 pF	2 k $\Omega$	open	GND	$2V_{CC(B)}$
1.65 V to 2.7 V	$V_{CC(A)}$	$\leq 1.0$ ns/V	15 pF	2 k $\Omega$	open	GND	$2V_{CC(B)}$
3.0 V to 3.6 V	$V_{CC(A)}$	$\leq 1.0$ ns/V	15 pF	2 k $\Omega$	open	GND	$2V_{CC(B)}$

[1]  $dV/dt \geq 1.0$  V/ns

11.2. Typical propagation delay characteristics

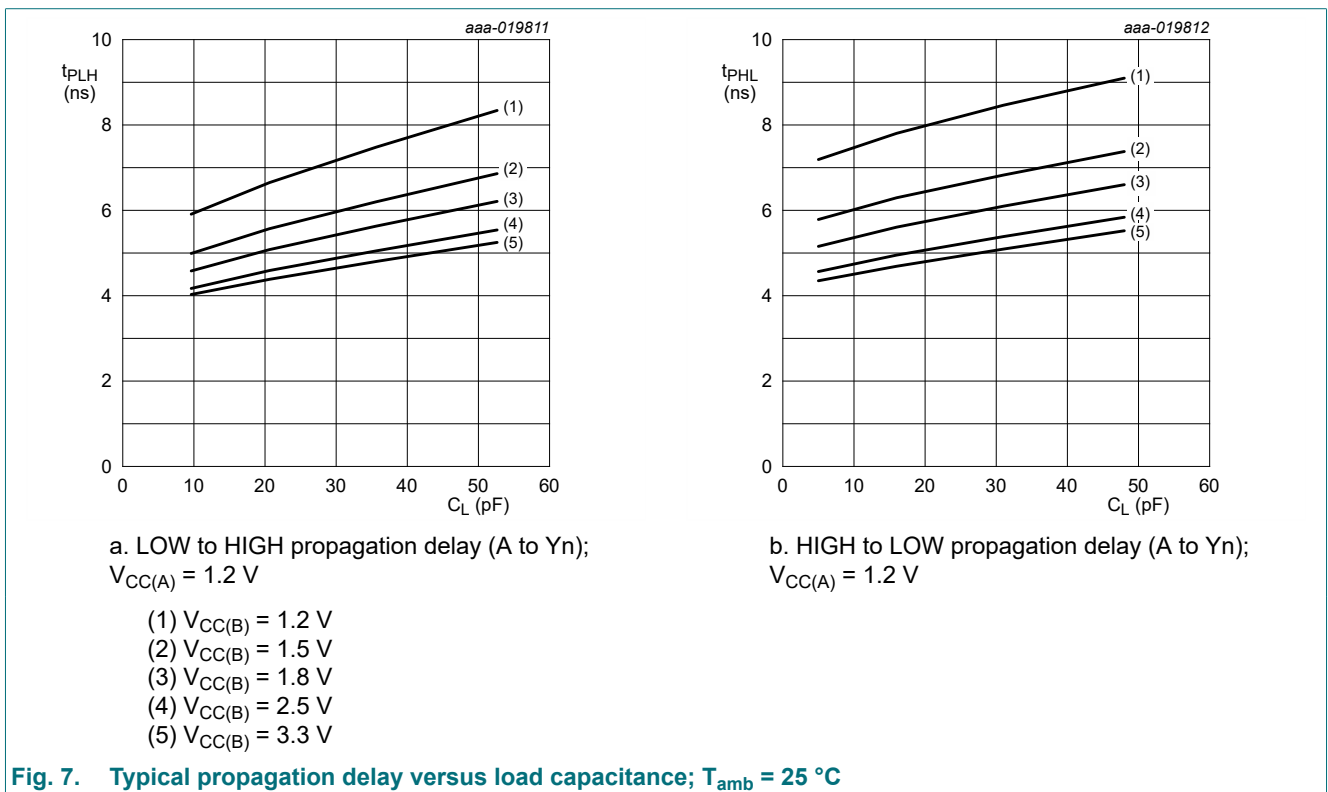
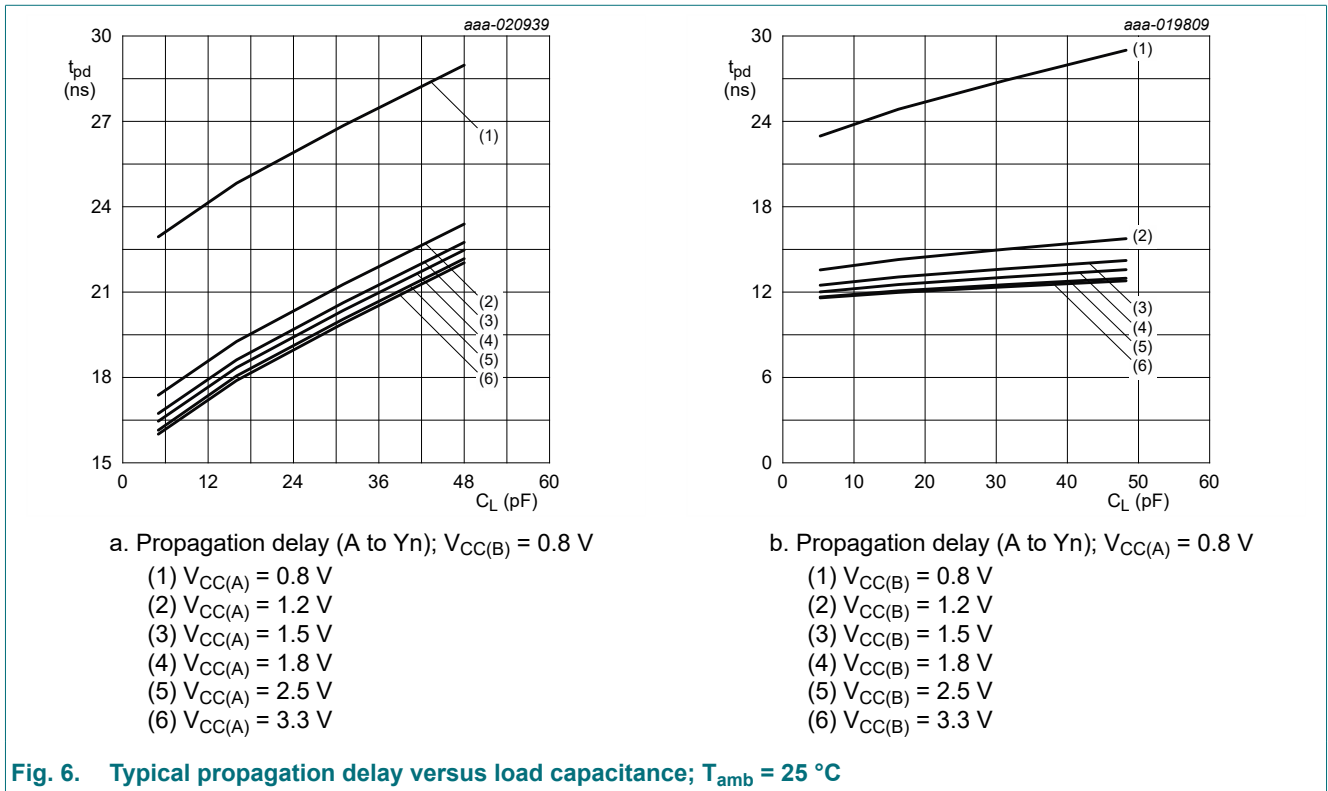

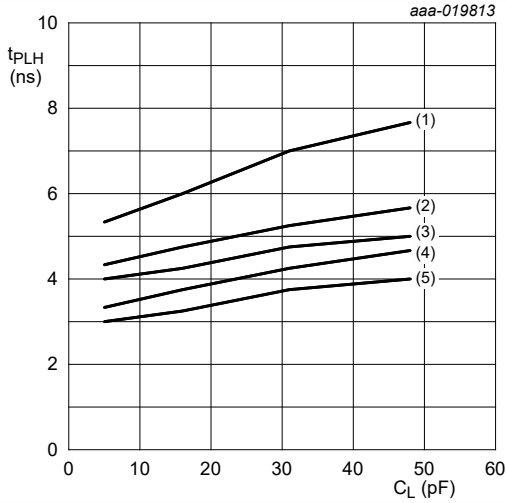

a. LOW to HIGH propagation delay (A to Yn);  
 $V_{CC(A)} = 1.5 \text{ V}$

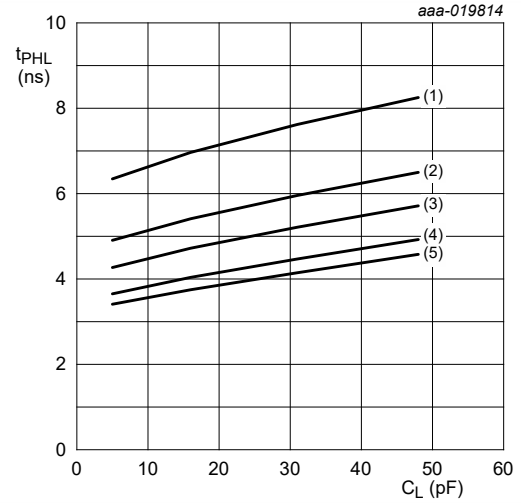

b. HIGH to LOW propagation delay (A to Yn);  
 $V_{CC(A)} = 1.5 \text{ V}$

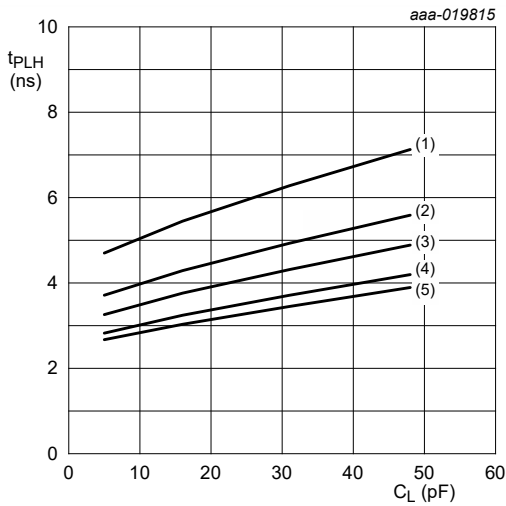

c. LOW to HIGH propagation delay (A to Yn);  
 $V_{CC(A)} = 1.8 \text{ V}$

- (1)  $V_{CC(B)} = 1.2 \text{ V}$
- (2)  $V_{CC(B)} = 1.5 \text{ V}$
- (3)  $V_{CC(B)} = 1.8 \text{ V}$
- (4)  $V_{CC(B)} = 2.5 \text{ V}$
- (5)  $V_{CC(B)} = 3.3 \text{ V}$

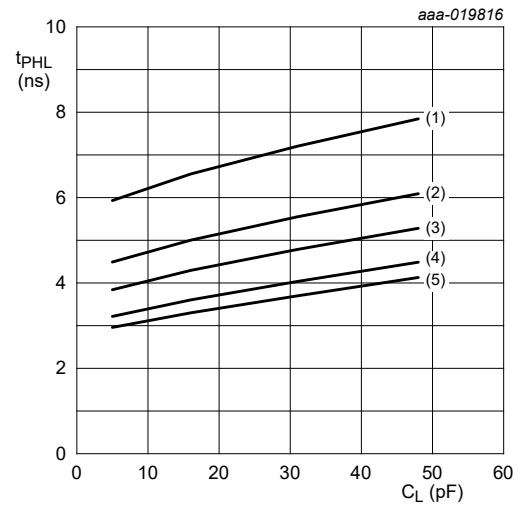

d. HIGH to LOW propagation delay (A to Yn);  
 $V_{CC(A)} = 1.8 \text{ V}$

Fig. 8. Typical propagation delay versus load capacitance;  $T_{amb} = 25 \text{ }^\circ\text{C}$

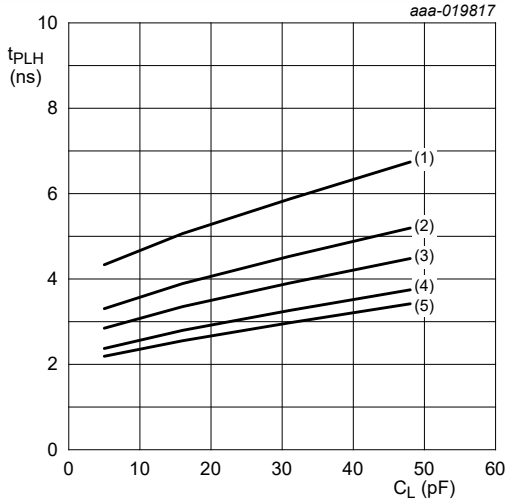

a. LOW to HIGH propagation delay (A to Yn);  
 $V_{CC(A)} = 2.5\text{ V}$

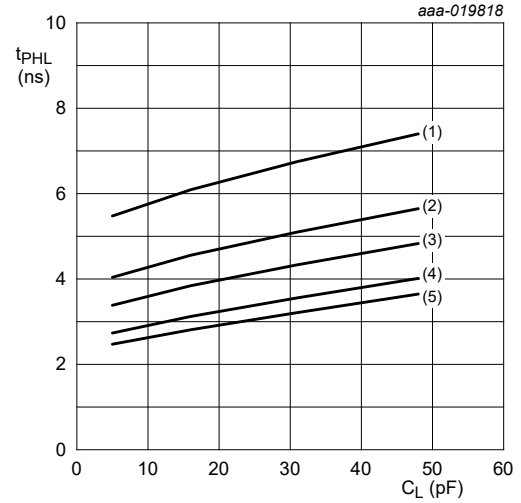

b. HIGH to LOW propagation delay (A to Yn);  
 $V_{CC(A)} = 2.5\text{ V}$

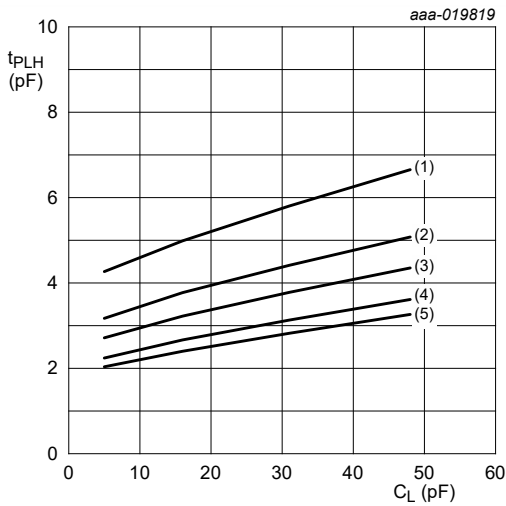

c. LOW to HIGH propagation delay (A to Yn);  
 $V_{CC(A)} = 3.3\text{ V}$

- (1)  $V_{CC(B)} = 1.2\text{ V}$
- (2)  $V_{CC(B)} = 1.5\text{ V}$
- (3)  $V_{CC(B)} = 1.8\text{ V}$
- (4)  $V_{CC(B)} = 2.5\text{ V}$
- (5)  $V_{CC(B)} = 3.3\text{ V}$

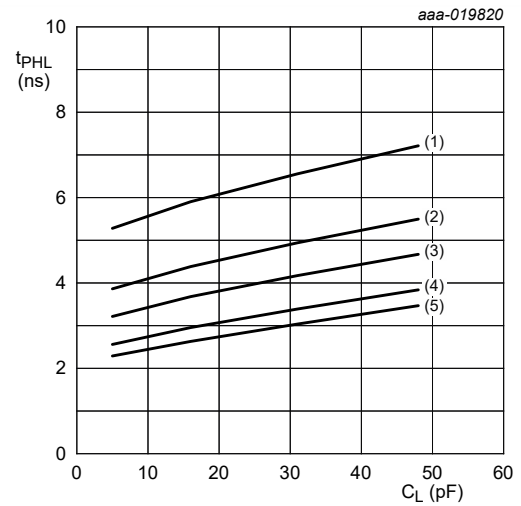

d. HIGH to LOW propagation delay (A to Yn);  
 $V_{CC(A)} = 3.3\text{ V}$

**Fig. 9. Typical propagation delay versus load capacitance;  $T_{amb} = 25\text{ }^{\circ}\text{C}$**

12. Package outline

TSSOP10: plastic thin shrink small outline package; 10 leads; body width 3 mm

SOT552-1

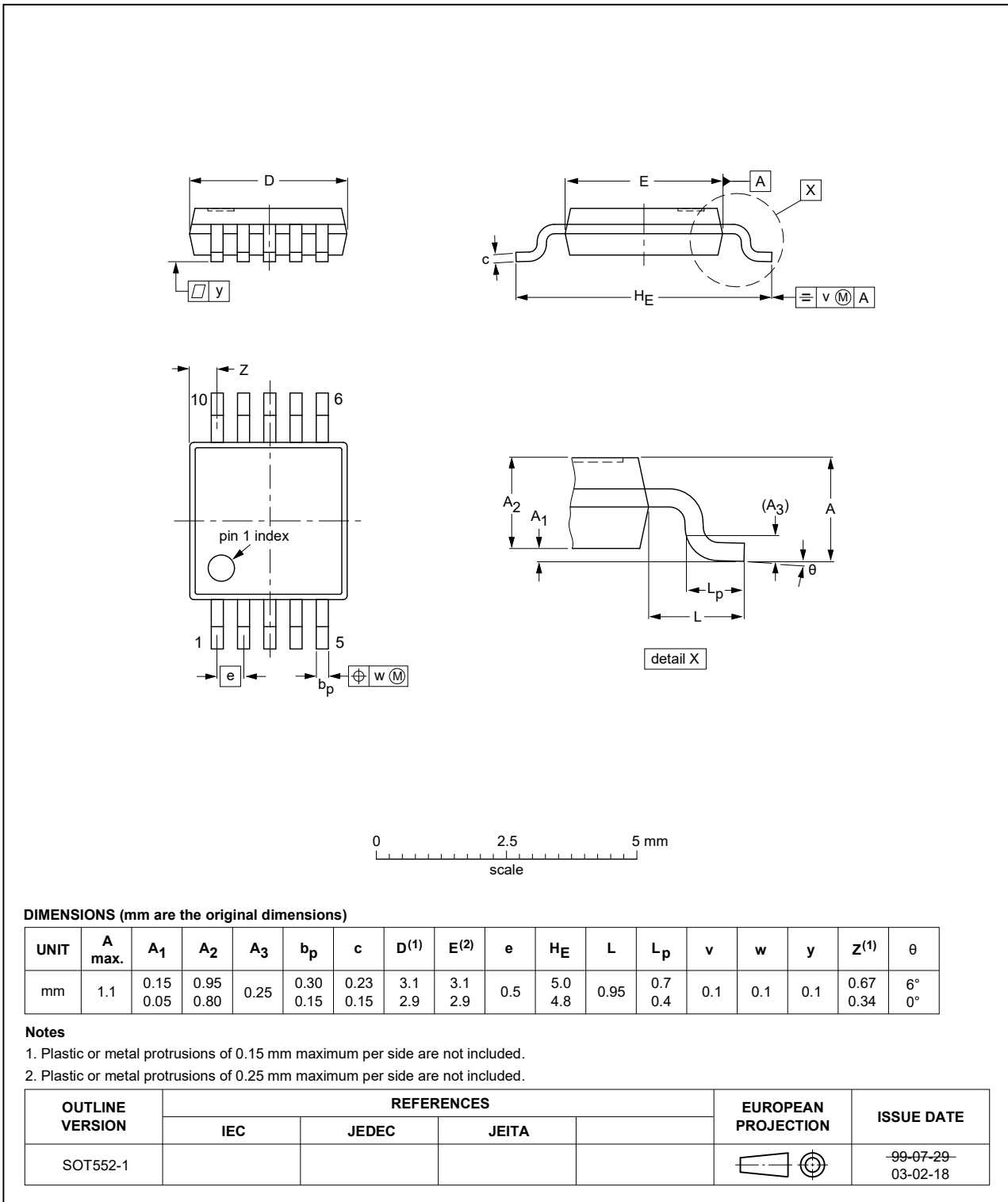

Fig. 10. Package outline SOT552-1 (TSSOP8)

## 13. Abbreviations

Table 17. Abbreviations

Acronym	Description
CDM	Charged Device Model
DUT	Device Under Test
ESD	ElectroStatic Discharge
HBM	Human Body Model

## 14. Revision history

Table 18. Revision history

Document ID	Release date	Data sheet status	Change notice	Supersedes
74AVC1T1004 v.2	20210301	Product data sheet	-	74AVC1T1004 v.1
Modifications:	<ul style="list-style-type: none"><li>Type number 74AVC1T1004GU33 (SOT1430-1) removed.</li><li><a href="#">Section 8</a>: Derating values for <math>P_{tot}</math> total power dissipation updated.</li></ul>			
74AVC1T1004 v.1	20180423	Product data sheet	-	-

## 15. Legal information

### Data sheet status

Document status [1][2]	Product status [3]	Definition
Objective [short] data sheet	Development	This document contains data from the objective specification for product development.
Preliminary [short] data sheet	Qualification	This document contains data from the preliminary specification.
Product [short] data sheet	Production	This document contains the product specification.

- [1] Please consult the most recently issued document before initiating or completing a design.
- [2] The term 'short data sheet' is explained in section "Definitions".
- [3] The product status of device(s) described in this document may have changed since this document was published and may differ in case of multiple devices. The latest product status information is available on the internet at <https://www.nexperia.com>.

### Definitions

**Draft** — The document is a draft version only. The content is still under internal review and subject to formal approval, which may result in modifications or additions. Nexperia does not give any representations or warranties as to the accuracy or completeness of information included herein and shall have no liability for the consequences of use of such information.

**Short data sheet** — A short data sheet is an extract from a full data sheet with the same product type number(s) and title. A short data sheet is intended for quick reference only and should not be relied upon to contain detailed and full information. For detailed and full information see the relevant full data sheet, which is available on request via the local Nexperia sales office. In case of any inconsistency or conflict with the short data sheet, the full data sheet shall prevail.

**Product specification** — The information and data provided in a Product data sheet shall define the specification of the product as agreed between Nexperia and its customer, unless Nexperia and customer have explicitly agreed otherwise in writing. In no event however, shall an agreement be valid in which the Nexperia product is deemed to offer functions and qualities beyond those described in the Product data sheet.

### Disclaimers

**Limited warranty and liability** — Information in this document is believed to be accurate and reliable. However, Nexperia does not give any representations or warranties, expressed or implied, as to the accuracy or completeness of such information and shall have no liability for the consequences of use of such information. Nexperia takes no responsibility for the content in this document if provided by an information source outside of Nexperia.

In no event shall Nexperia be liable for any indirect, incidental, punitive, special or consequential damages (including - without limitation - lost profits, lost savings, business interruption, costs related to the removal or replacement of any products or rework charges) whether or not such damages are based on tort (including negligence), warranty, breach of contract or any other legal theory.

Notwithstanding any damages that customer might incur for any reason whatsoever, Nexperia's aggregate and cumulative liability towards customer for the products described herein shall be limited in accordance with the Terms and conditions of commercial sale of Nexperia.

**Right to make changes** — Nexperia reserves the right to make changes to information published in this document, including without limitation specifications and product descriptions, at any time and without notice. This document supersedes and replaces all information supplied prior to the publication hereof.

**Suitability for use** — Nexperia products are not designed, authorized or warranted to be suitable for use in life support, life-critical or safety-critical systems or equipment, nor in applications where failure or malfunction of an Nexperia product can reasonably be expected to result in personal

injury, death or severe property or environmental damage. Nexperia and its suppliers accept no liability for inclusion and/or use of Nexperia products in such equipment or applications and therefore such inclusion and/or use is at the customer's own risk.

**Quick reference data** — The Quick reference data is an extract of the product data given in the Limiting values and Characteristics sections of this document, and as such is not complete, exhaustive or legally binding.

**Applications** — Applications that are described herein for any of these products are for illustrative purposes only. Nexperia makes no representation or warranty that such applications will be suitable for the specified use without further testing or modification.

Customers are responsible for the design and operation of their applications and products using Nexperia products, and Nexperia accepts no liability for any assistance with applications or customer product design. It is customer's sole responsibility to determine whether the Nexperia product is suitable and fit for the customer's applications and products planned, as well as for the planned application and use of customer's third party customer(s). Customers should provide appropriate design and operating safeguards to minimize the risks associated with their applications and products.

Nexperia does not accept any liability related to any default, damage, costs or problem which is based on any weakness or default in the customer's applications or products, or the application or use by customer's third party customer(s). Customer is responsible for doing all necessary testing for the customer's applications and products using Nexperia products in order to avoid a default of the applications and the products or of the application or use by customer's third party customer(s). Nexperia does not accept any liability in this respect.

**Limiting values** — Stress above one or more limiting values (as defined in the Absolute Maximum Ratings System of IEC 60134) will cause permanent damage to the device. Limiting values are stress ratings only and (proper) operation of the device at these or any other conditions above those given in the Recommended operating conditions section (if present) or the Characteristics sections of this document is not warranted. Constant or repeated exposure to limiting values will permanently and irreversibly affect the quality and reliability of the device.

**Terms and conditions of commercial sale** — Nexperia products are sold subject to the general terms and conditions of commercial sale, as published at <http://www.nexperia.com/profile/terms>, unless otherwise agreed in a valid written individual agreement. In case an individual agreement is concluded only the terms and conditions of the respective agreement shall apply. Nexperia hereby expressly objects to applying the customer's general terms and conditions with regard to the purchase of Nexperia products by customer.

**No offer to sell or license** — Nothing in this document may be interpreted or construed as an offer to sell products that is open for acceptance or the grant, conveyance or implication of any license under any copyrights, patents or other industrial or intellectual property rights.

**Export control** — This document as well as the item(s) described herein may be subject to export control regulations. Export might require a prior authorization from competent authorities.

**Non-automotive qualified products** — Unless this data sheet expressly states that this specific Nexperia product is automotive qualified, the product is not suitable for automotive use. It is neither qualified nor tested in accordance with automotive testing or application requirements. Nexperia accepts no liability for inclusion and/or use of non-automotive qualified products in automotive equipment or applications.

In the event that customer uses the product for design-in and use in automotive applications to automotive specifications and standards, customer (a) shall use the product without Nexperia's warranty of the product for such automotive applications, use and specifications, and (b) whenever customer uses the product for automotive applications beyond Nexperia's specifications such use shall be solely at customer's own risk, and (c) customer fully indemnifies Nexperia for any liability, damages or failed product claims resulting from customer design and use of the product for automotive applications beyond Nexperia's standard warranty and Nexperia's product specifications.

**Translations** — A non-English (translated) version of a document is for reference only. The English version shall prevail in case of any discrepancy between the translated and English versions.

### Trademarks

Notice: All referenced brands, product names, service names and trademarks are the property of their respective owners.

## Contents

<b>1. General description</b> .....	<b>1</b>
<b>2. Features and benefits</b> .....	<b>1</b>
<b>3. Ordering information</b> .....	<b>2</b>
<b>4. Marking</b> .....	<b>2</b>
<b>5. Functional diagram</b> .....	<b>2</b>
<b>6. Pinning information</b> .....	<b>3</b>
6.1. Pinning.....	3
6.2. Pin description.....	3
<b>7. Functional description</b> .....	<b>3</b>
<b>8. Limiting values</b> .....	<b>4</b>
<b>9. Recommended operating conditions</b> .....	<b>4</b>
<b>10. Static characteristics</b> .....	<b>5</b>
<b>11. Dynamic characteristics</b> .....	<b>6</b>
11.1. Waveforms and test circuit.....	10
11.2. Typical propagation delay characteristics.....	12
<b>12. Package outline</b> .....	<b>15</b>
<b>13. Abbreviations</b> .....	<b>16</b>
<b>14. Revision history</b> .....	<b>16</b>
<b>15. Legal information</b> .....	<b>17</b>

© Nexperia B.V. 2021. All rights reserved

For more information, please visit: <http://www.nexperia.com>  
For sales office addresses, please send an email to: [salesaddresses@nexperia.com](mailto:salesaddresses@nexperia.com)  
Date of release: 1 March 2021