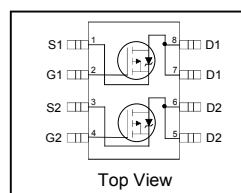
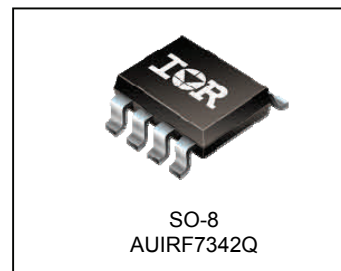


**Features**

- Advanced Planar Technology
- Low On-Resistance
- Logic Level Gate Drive
- Dual P Channel MOSFET
- Dynamic dv/dt Rating
- 150°C Operating Temperature
- Fast Switching
- Fully Avalanche Rated
- Lead-Free, RoHS Compliant
- Automotive Qualified \*



$V_{DSS}$		<b>-55V</b>
$R_{DS(on)}$ max.		<b>0.105Ω</b>
$I_D$		<b>-3.4A</b>



<b>G</b>	<b>D</b>	<b>S</b>
Gate	Drain	Source

**Description**

Specifically designed for Automotive applications, this cellular design of HEXFET® Power MOSFETs utilizes the latest processing techniques to achieve low on-resistance per silicon area. This benefit combined with the fast switching speed and ruggedized device design that HEXFET power MOSFETs are well known for, provides the designer with an extremely efficient and reliable device for use in Automotive and a wide variety of other applications.

Base part number	Package Type	Standard Pack		Orderable Part Number
		Form	Quantity	
AUIRF7342Q	SO-8	Tape and Reel	4000	AUIRF7342QTR

**Absolute Maximum Ratings**

Stresses beyond those listed under “Absolute Maximum Ratings” may cause permanent damage to the device. These are stress ratings only; and functional operation of the device at these or any other condition beyond those indicated in the specifications is not implied. Exposure to absolute-maximum-rated conditions for extended periods may affect device reliability. The thermal resistance and power dissipation ratings are measured under board mounted and still air conditions. Ambient temperature (TA) is 25°C, unless otherwise specified.

Symbol	Parameter	Max.	Units
$V_{DS}$	Drain-Source Voltage	-55	V
$I_D @ T_A = 25^\circ C$	Continuous Drain Current, $V_{GS} @ -10V$	-3.4	A
$I_D @ T_A = 70^\circ C$	Continuous Drain Current, $V_{GS} @ -10V$	-2.7	
$I_{DM}$	Pulsed Drain Current ①	-27	
$P_D @ T_A = 25^\circ C$	Maximum Power Dissipation ①	2.0	W
$P_D @ T_A = 70^\circ C$	Maximum Power Dissipation	1.3	
	Linear Dearing Factor	0.016	mW°/C
$V_{GS}$	Gate-to-Source Voltage	± 20	V
$V_{GSM}$	Gate-to-Source Voltage Single Pulse $t_p < 10\mu s$	30	
$E_{AS}$	Single Pulse Avalanche Energy (Thermally Limited) ②	114	mJ
dv/dt	Peak Diode Recovery dv/dt ③	5.0	V/ns
$T_J$ $T_{STG}$	Operating Junction and Storage Temperature Range	-55 to + 150	°C

**Thermal Resistance**

Symbol	Parameter	Typ.	Max.	Units
$R_{\theta JA}$	Junction-to-Ambient ④	—	62.5	°C/W

HEXFET® is a registered trademark of Infineon.

\*Qualification standards can be found at [www.infineon.com](http://www.infineon.com)


**Static @  $T_J = 25^\circ\text{C}$  (unless otherwise specified)**

	Parameter	Min.	Typ.	Max.	Units	Conditions
$V_{(BR)DSS}$	Drain-to-Source Breakdown Voltage	-55	—	—	V	$V_{GS} = 0V, I_D = -250\mu A$
$\Delta V_{(BR)DSS}/\Delta T_J$	Breakdown Voltage Temp. Coefficient	—	-0.054	—	V/ $^\circ\text{C}$	Reference to $25^\circ\text{C}$ , $I_D = -1\text{mA}$
$R_{DS(on)}$	Static Drain-to-Source On-Resistance	—	0.095	0.105	$\Omega$	$V_{GS} = -10V, I_D = -3.4A$ ④
		—	0.150	0.170		$V_{GS} = -4.5V, I_D = -2.7A$ ④
$V_{GS(th)}$	Gate Threshold Voltage	-1.0	—	-3.0	V	$V_{DS} = V_{GS}, I_D = -250\mu A$
$g_{fs}$	Forward Trans conductance	3.3	—	—	S	$V_{DS} = -10V, I_D = -3.1A$
$I_{DSS}$	Drain-to-Source Leakage Current	—	—	-2.0	$\mu A$	$V_{DS} = -55V, V_{GS} = 0V$
		—	—	-25		$V_{DS} = -55V, V_{GS} = 0V, T_J = 55^\circ\text{C}$
$I_{GSS}$	Gate-to-Source Forward Leakage	—	—	-100	nA	$V_{GS} = -20V$
	Gate-to-Source Reverse Leakage	—	—	100		$V_{GS} = 20V$

**Dynamic Electrical Characteristics @  $T_J = 25^\circ\text{C}$  (unless otherwise specified)**

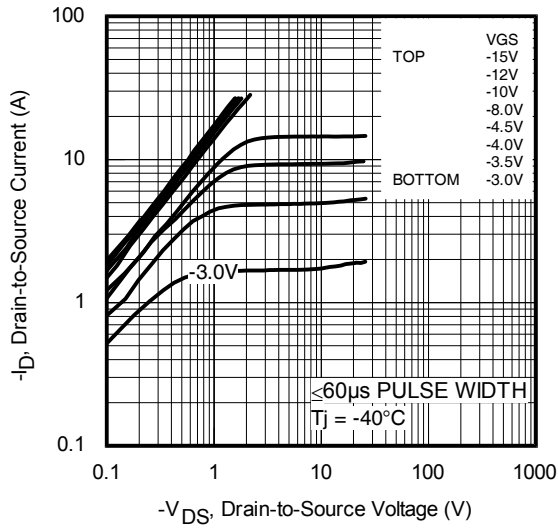
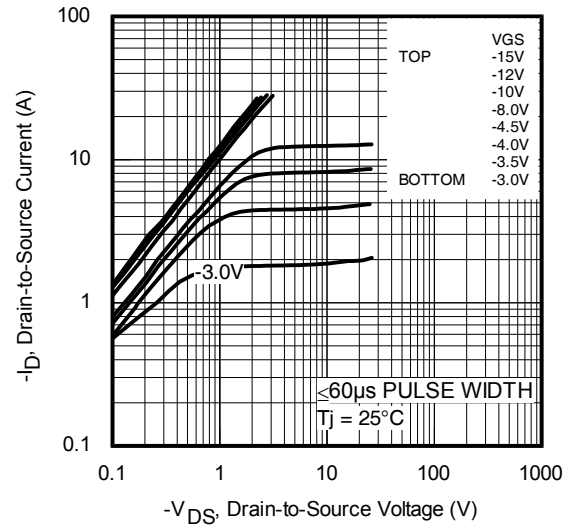
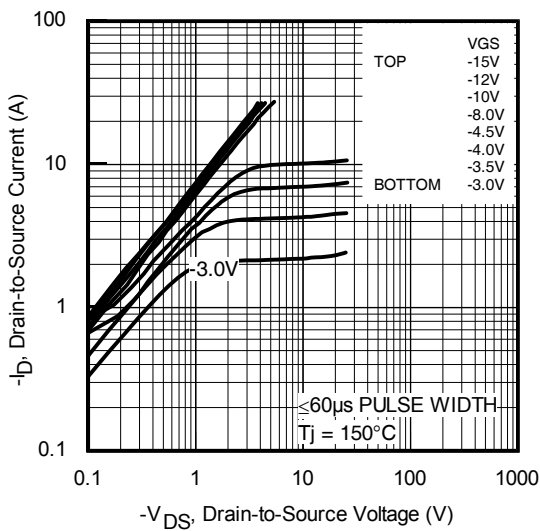
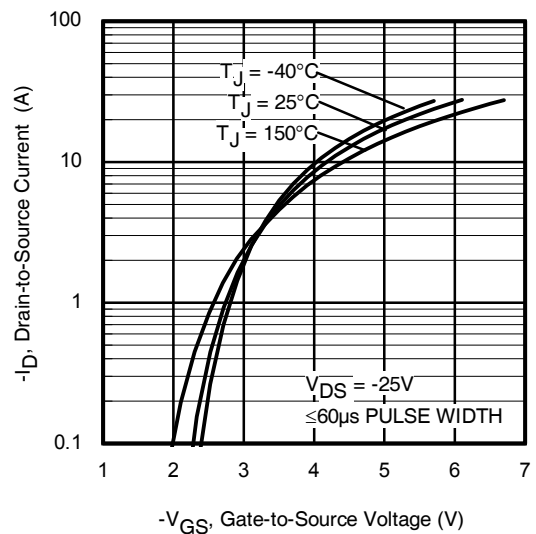
$Q_g$	Total Gate Charge	—	26	38	nC	$I_D = -3.1A$
$Q_{gs}$	Gate-to-Source Charge	—	3.0	4.5		$V_{DS} = -44V$
$Q_{gd}$	Gate-to-Drain Charge	—	8.4	13		$V_{GS} = -10V$ , See Fig.10 ④
$t_{d(on)}$	Turn-On Delay Time	—	14	22	ns	$V_{DD} = -28V$
$t_r$	Rise Time	—	10	15		$I_D = -1.0A$
$t_{d(off)}$	Turn-Off Delay Time	—	43	64		$R_G = 6.0\Omega$
$t_f$	Fall Time	—	22	32		$R_D = 16\Omega$ ④
$C_{iss}$	Input Capacitance	—	690	—	pF	$V_{GS} = 0V$
$C_{oss}$	Output Capacitance	—	210	—		$V_{DS} = -25V$
$C_{rss}$	Reverse Transfer Capacitance	—	86	—		$f = 1.0\text{MHz}$ , See Fig.9

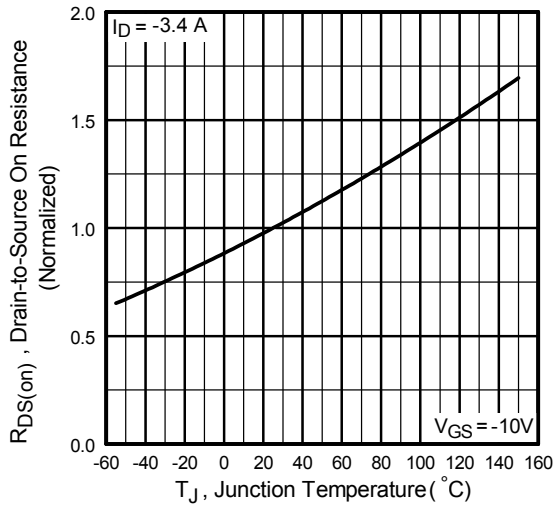
**Diode Characteristics**

	Parameter	Min.	Typ.	Max.	Units	Conditions
$I_S$	Continuous Source Current (Body Diode)	—	—	-2.0	A	MOSFET symbol showing the integral reverse p-n junction diode. 
$I_{SM}$	Pulsed Source Current (Body Diode) ①	—	—	-27		
$V_{SD}$	Diode Forward Voltage	—	—	-1.2	V	$T_J = 25^\circ\text{C}, I_S = -2.0A, V_{GS} = 0V$ ④
$t_{rr}$	Reverse Recovery Time	—	54	80	ns	$T_J = 25^\circ\text{C}, I_F = -2.0A$ ,
$Q_{rr}$	Reverse Recovery Charge	—	85	130	nC	$di/dt = 100A/\mu s$ ④

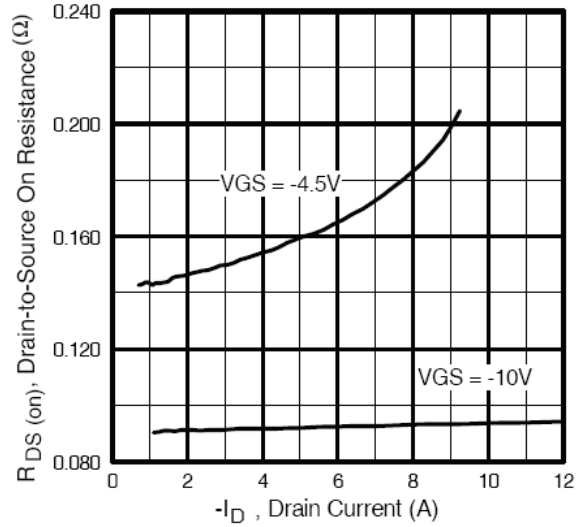
**Notes:**

- ① Repetitive rating; pulse width limited by max. junction temperature. (See Fig. 11)
- ② Starting  $T_J = 25^\circ\text{C}$ ,  $L = 20\text{mH}$ ,  $R_G = 25\Omega$ ,  $I_{AS} = -3.4A$ . (See Fig. 8)
- ③  $I_{SD} \leq -3.4A$ ,  $di/dt \leq 150A/\mu s$ ,  $V_{DD} \leq V_{(BR)DSS}$ ,  $T_J \leq 150^\circ\text{C}$ .
- ④ Pulse width  $\leq 300\mu s$ ; duty cycle  $\leq 2\%$ .
- ⑤ When mounted on 1" square copper board,  $t < 10\text{sec}$ .

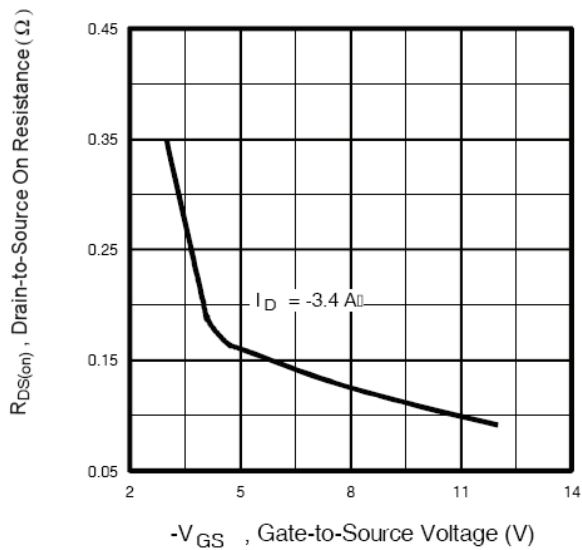

**Fig. 1** Typical Output Characteristics

**Fig. 2** Typical Output Characteristics

**Fig. 3** Typical Output Characteristics

**Fig. 4** Typical Transfer Characteristics



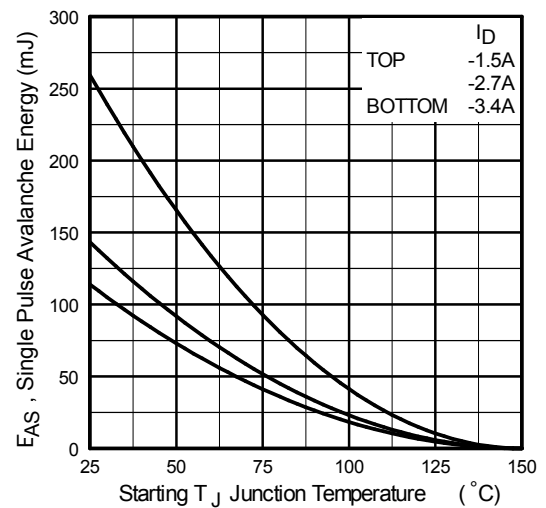
**Fig 5.** Normalized On-Resistance Vs. Temperature



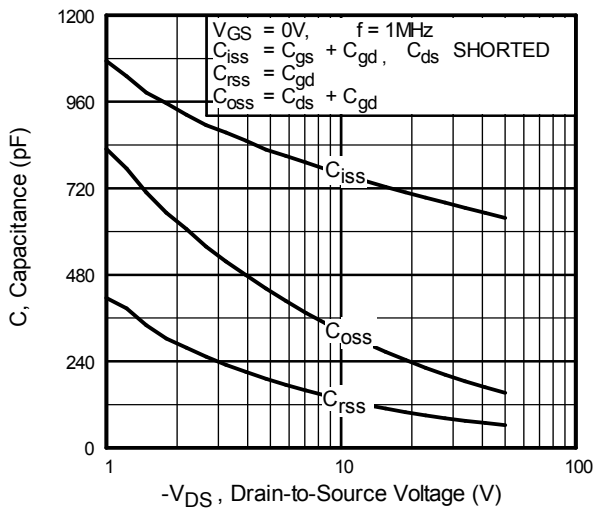
**Fig 6.** Typical On-Resistance Vs. Drain Current



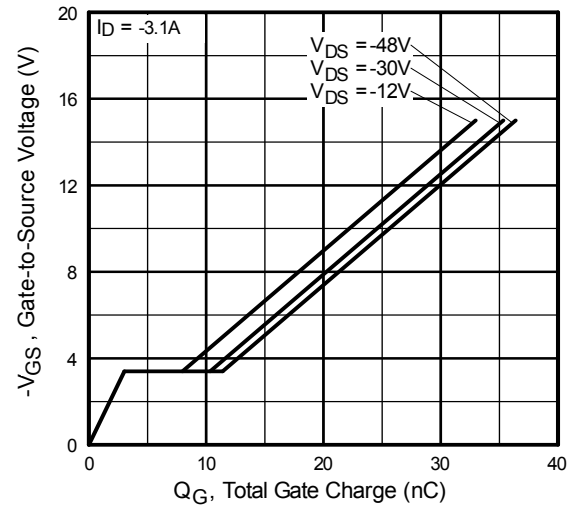
**Fig. 7** Typical On-Resistance Vs. Gate Voltage



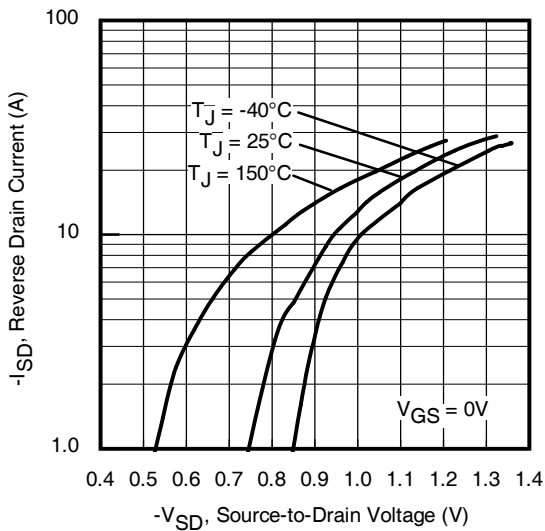
**Fig 8.** Maximum Avalanche Energy Vs. Drain Current



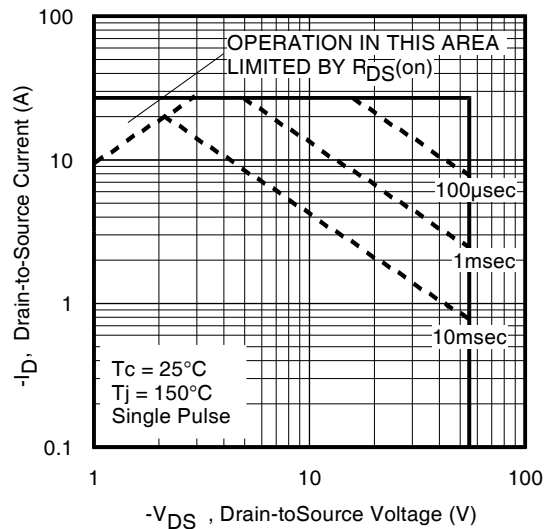
**Fig 9.** Typical Capacitance Vs. Drain-to-Source Voltage



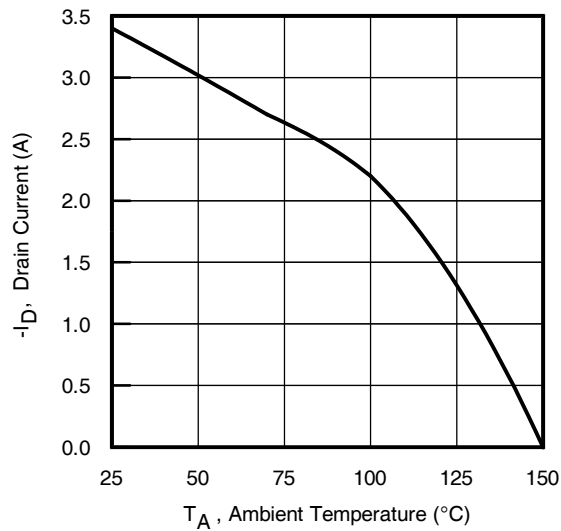
**Fig 10.** Typical Gate Charge Vs. Gate-to-Source Voltage



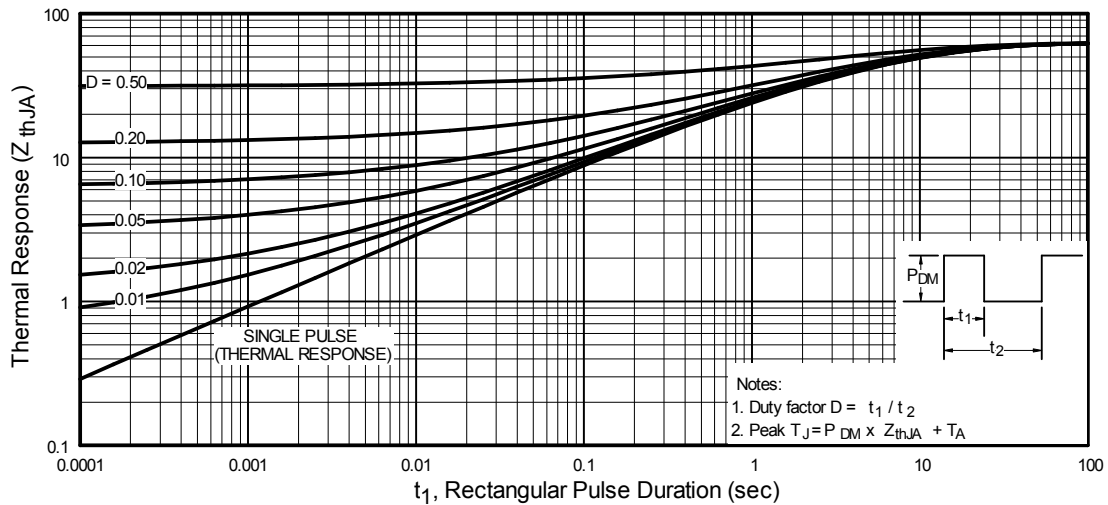
**Fig. 11** Typical Source-Drain Diode Forward Voltage



**Fig. 12** Maximum Safe Operating Area

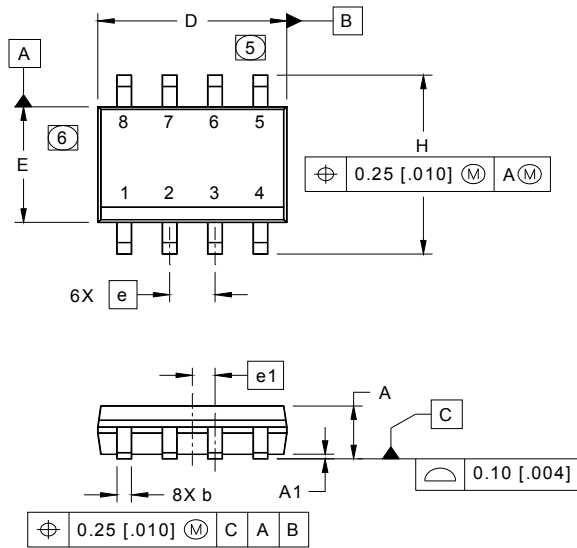


**Fig 13.** Maximum Drain Current vs. Ambient Temperature



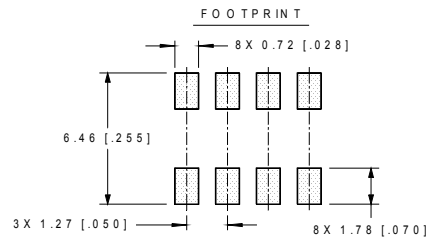
**Fig 14.** Maximum Effective Transient Thermal Impedance, Junction-to-Ambient

## SO-8 Package Outline (Dimensions are shown in millimeters (inches))

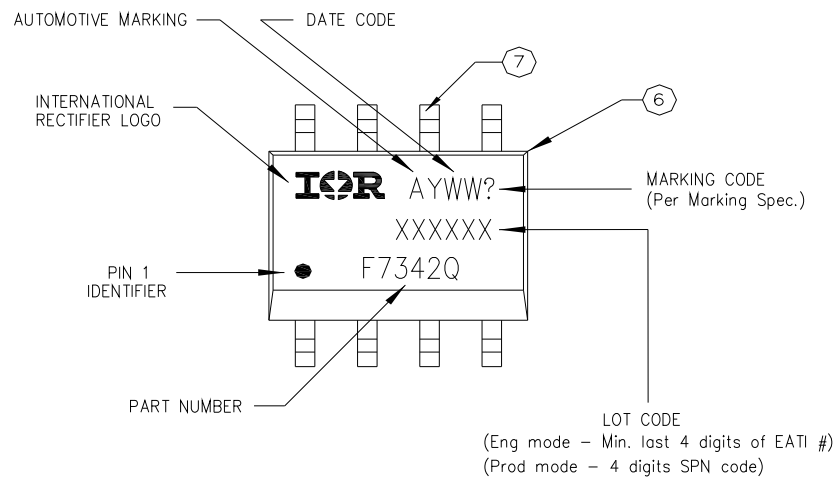


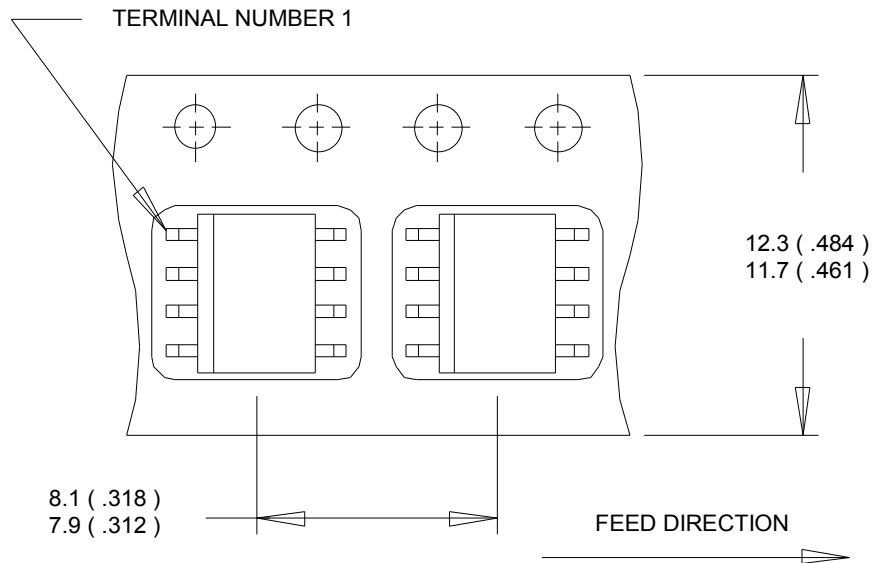
DIM	INCHES		MILLIMETERS	
	MIN	MAX	MIN	MAX
A	.0532	.0688	1.35	1.75
A1	.0040	.0098	0.10	0.25
b	.013	.020	0.33	0.51
c	.0075	.0098	0.19	0.25
D	.189	.1968	4.80	5.00
E	.1497	.1574	3.80	4.00
e	.050 BASIC		1.27 BASIC	
e 1	.025 BASIC		0.635 BASIC	
H	.2284	.2440	5.80	6.20
K	.0099	.0196	0.25	0.50
L	.016	.050	0.40	1.27
y	0°	8°	0°	8°

- NOTES:
1. DIMENSIONING & TOLERANCING PER ASME Y14.5M-1994.
  2. CONTROLLING DIMENSION: MILLIMETER
  3. DIMENSIONS ARE SHOWN IN MILLIMETERS [INCHES].
  4. OUTLINE CONFORMS TO JEDEC OUTLINE MS-012AA.
  5. DIMENSION DOES NOT INCLUDE MOLD PROTRUSIONS. MOLD PROTRUSIONS NOT TO EXCEED 0.15 [.006].
  6. DIMENSION DOES NOT INCLUDE MOLD PROTRUSIONS. MOLD PROTRUSIONS NOT TO EXCEED 0.25 [.010].
  7. DIMENSION IS THE LENGTH OF LEAD FOR SOLDERING TO A SUBSTRATE.

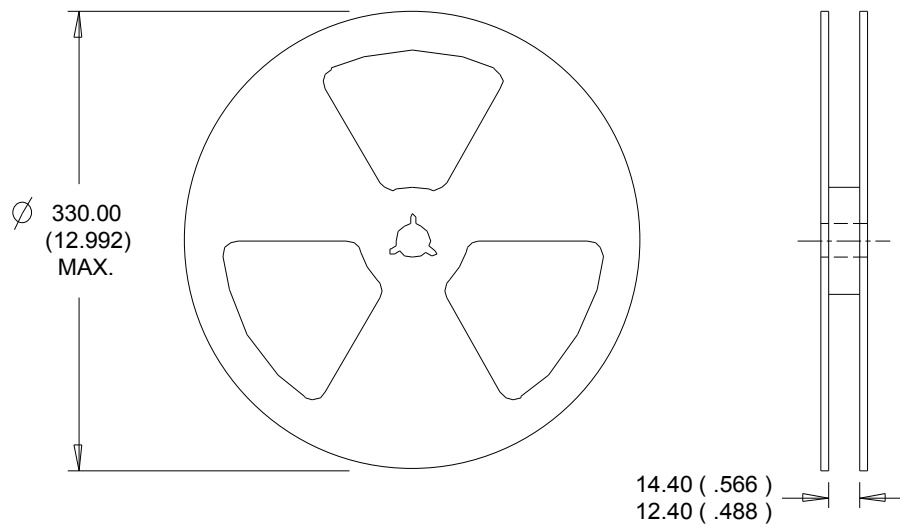


## SO-8 Part Marking Information



**SO-8 Tape and Reel** (Dimensions are shown in millimeters (inches))

**NOTES:**

1. CONTROLLING DIMENSION : MILLIMETER.
2. ALL DIMENSIONS ARE SHOWN IN MILLIMETERS(INCHES).
3. OUTLINE CONFORMS TO EIA-481 & EIA-541.


**NOTES :**

1. CONTROLLING DIMENSION : MILLIMETER.
2. OUTLINE CONFORMS TO EIA-481 & EIA-541.

**Qualification Information**

<b>Qualification Level</b>		Automotive (per AEC-Q101)	
		Comments: This part number(s) passed Automotive qualification. Infineon's Industrial and Consumer qualification level is granted by extension of the higher Automotive level.	
<b>Moisture Sensitivity Level</b>		SO-8	MSL1
<b>ESD</b>	Machine Model	Class M2 (+/- 200V) <sup>†</sup> AEC-Q101-002	
	Human Body Model	Class H1A (+/- 500V) <sup>†</sup> AEC-Q101-001	
	Charged Device Model	Class C5 (+/- 1125V) <sup>†</sup> AEC-Q101-005	
<b>RoHS Compliant</b>		Yes	

† Highest passing voltage.

**Revision History**

Date	Comments
3/27/2014	<ul style="list-style-type: none"> <li>Added "Logic Level Gate Drive" bullet in the features section on page 1</li> <li>Updated data sheet with new IR corporate template</li> </ul>
9/30/2015	<ul style="list-style-type: none"> <li>Updated datasheet with corporate template</li> <li>Corrected ordering table on page 1.</li> </ul>

**Published by**  
**Infineon Technologies AG**  
**81726 München, Germany**  
 © Infineon Technologies AG 2015  
**All Rights Reserved.**

**IMPORTANT NOTICE**

The information given in this document shall in no event be regarded as a guarantee of conditions or characteristics ("Beschaffenhheitsgarantie"). With respect to any examples, hints or any typical values stated herein and/or any information regarding the application of the product, Infineon Technologies hereby disclaims any and all warranties and liabilities of any kind, including without limitation warranties of non-infringement of intellectual property rights of any third party.

In addition, any information given in this document is subject to customer's compliance with its obligations stated in this document and any applicable legal requirements, norms and standards concerning customer's products and any use of the product of Infineon Technologies in customer's applications.

The data contained in this document is exclusively intended for technically trained staff. It is the responsibility of customer's technical departments to evaluate the suitability of the product for the intended application and the completeness of the product information given in this document with respect to such application.

For further information on the product, technology, delivery terms and conditions and prices please contact your nearest Infineon Technologies office ([www.infineon.com](http://www.infineon.com)).

**WARNINGS**

Due to technical requirements products may contain dangerous substances. For information on the types in question please contact your nearest Infineon Technologies office.

Except as otherwise explicitly approved by Infineon Technologies in a written document signed by authorized representatives of Infineon Technologies, Infineon Technologies' products may not be used in any applications where a failure of the product or any consequences of the use thereof can reasonably be expected to result in personal injury.