

HITFET - BTS3050EJ

Smart Low-Side Power Switch



1 Overview

Basic Features

- Single channel device
- Very low output leakage current in OFF state
- Electrostatic discharge protection (ESD)
- Embedded protection functions (see below)
- ELV compliant package
- Green Product (RoHS compliant)
- AEC Qualified

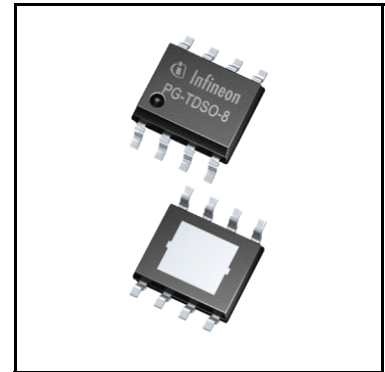

Applications

- Suitable for resistive, inductive and capacitive loads
- Replaces electromechanical relays, fuses and discrete circuits

Description

The BTS3050EJ is a 50 mΩ single channel Smart Low-Side Power Switch with in a PG-TDSO8-31 package providing embedded protective functions. The power transistor is built by an N-channel vertical power MOSFET.

The device is monolithically integrated. The BTS3050EJ is automotive qualified and is optimized for 12 V automotive applications.

Type	Package	Marking
BTS3050EJ	PG-TDSO8-31	S3050EJ

Table 1 Product Summary

Operating voltage range	V_{OUT}	0 .. 31 V
Maximum load voltage	$V_{BAT(LD)}$	40 V
Maximum input voltage	V_{IN}	5.5 V
Maximum On-State resistance at $T_J = 150^{\circ}\text{C}, V_{IN} = 5\text{ V}$	$R_{DS(ON)}$	100 mΩ
Nominal load current	$I_{L(NOM)}$	4 A
Minimum current limitation	$I_{L(LIM)}$	15 A
Maximum OFF state load current at $T_J \leq 85^{\circ}\text{C}$	$I_{L(OFF)}$	2 μA

Overview

Diagnostic Functions

- open-drain status output

Protection Functions

- Over temperature shut-down with automatic-restart
- Active clamp over voltage protection
- Current limitation

Detailed Description

The device is able to switch all kind of resistive, inductive and capacitive loads, limited by maximum clamping energy and maximum current capabilities.

The BTS3050EJ offers ESD protection on the IN pin which refers to the Source pin (Ground).

The over temperature protection prevents the device from overheating due to overload and/or bad cooling conditions. The temperature information is given by a temperature sensor in the power MOSFET.

The BTS3050EJ has an auto-restart thermal shut-down function. The device will turn on again, if input is still high, after the measured temperature has dropped below the thermal hysteresis.

The over voltage protection can be activated during load dump or inductive turn off conditions. The power MOSFET is limiting the drain-source voltage, if it rises above the $V_{OUT(CLAMP)}$.

Table of Contents

1	Overview	1
	Table of Contents	3
2	Block Diagram	5
3	Pin Configuration	6
3.1	Pin Assignment BTS3050EJ	6
3.2	Pin Definitions and Functions	6
3.3	Voltage and current definition	7
4	General Product Characteristics	8
4.1	Absolute Maximum Ratings	8
4.2	Functional Range	10
4.3	Thermal Resistance	11
4.3.1	PCB set up	11
4.3.2	Transient Thermal Impedance	12
5	Power Stage	14
5.1	Output On-state Resistance	14
5.2	Resistive Load Output Timing	14
5.3	Inductive Load	15
5.3.1	Output Clamping	15
5.3.1.1	Maximum Load Inductance	16
5.4	Reverse Current capability	16
5.5	Inverse Current capability	17
5.6	Characteristics	17
6	Protection Functions	18
6.1	Over Voltage Clamping on OUTput	18
6.2	Thermal Protection	18
6.3	Short Circuit Protection / Current limitation	18
6.4	Characteristics	19
7	Input Stage	20
7.1	Input Circuit	20
7.2	Characteristics	20
8	Diagnostics	21
9	Electrical Characteristics	22
9.1	Power Stage	22
9.2	Protection	24
9.3	Input Stage	25
9.4	Diagnostics (STATUS Pin)	25
10	Characterization Results	26
10.1	Power Stage	26
10.2	Protection	37
10.3	Input Stage	38
10.4	Diagnosis	40
11	Application Information	42

11.1	Application Diagram	42
12	Package Outlines	43
13	Revision History	44

Block Diagram

2 Block Diagram

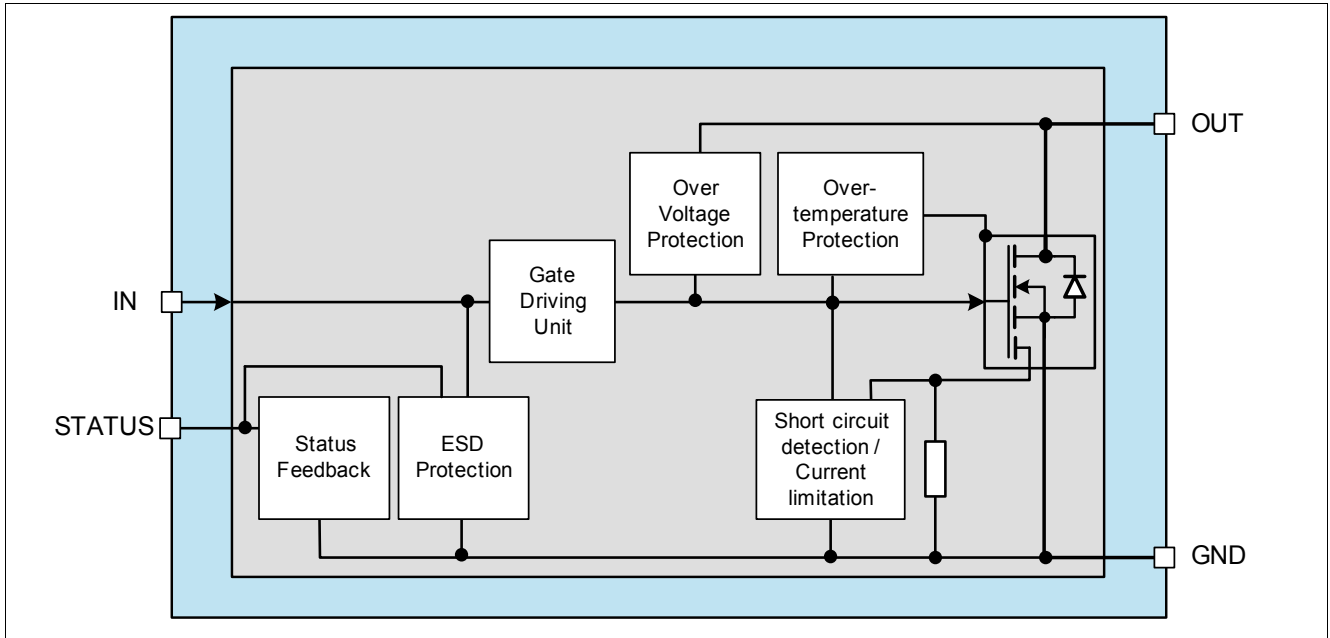

Figure 1 Block Diagram

Pin Configuration

3 Pin Configuration

3.1 Pin Assignment BTS3050EJ

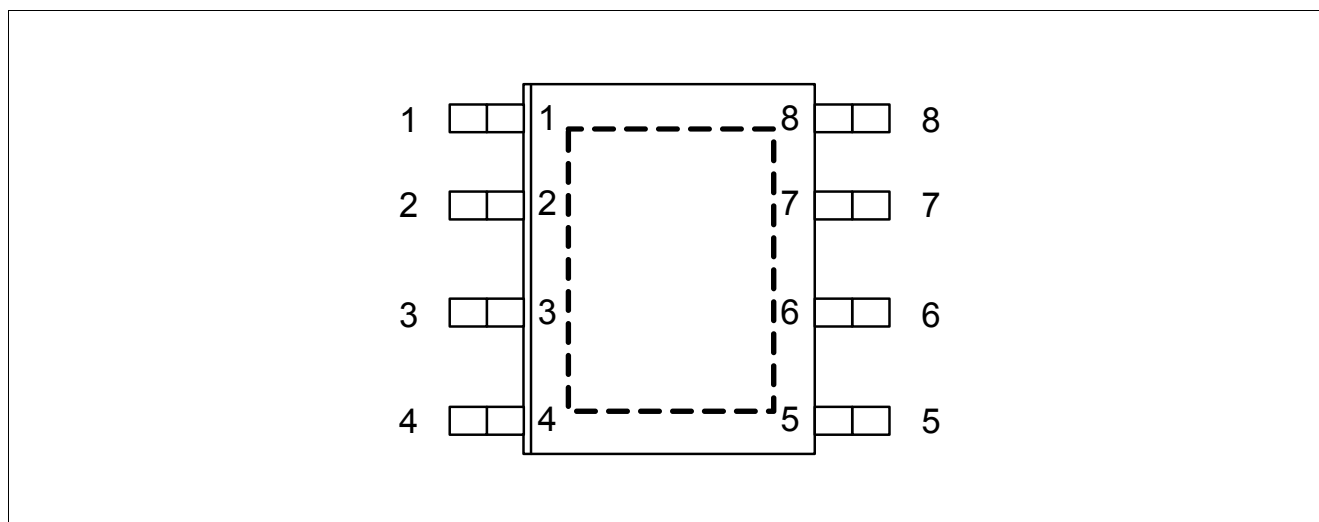

Figure 2 Pin Configuration

3.2 Pin Definitions and Functions

Pin	Symbol	Function
1	IN	Input pin
2	NC	not connected
3	STATUS	Open-drain status feedback (low active)
4	NC	not connected
5	NC	not connected
6, 7, 8	GND	Ground, Source of power DMOS ¹⁾
cooling tab	OUT	Drain, Load connection for power DMOS

1) All GND pins must be connected together.

Pin Configuration

3.3 Voltage and current definition

Figure 3 shows all external terms used in this datasheet, with associated convention for positive values.

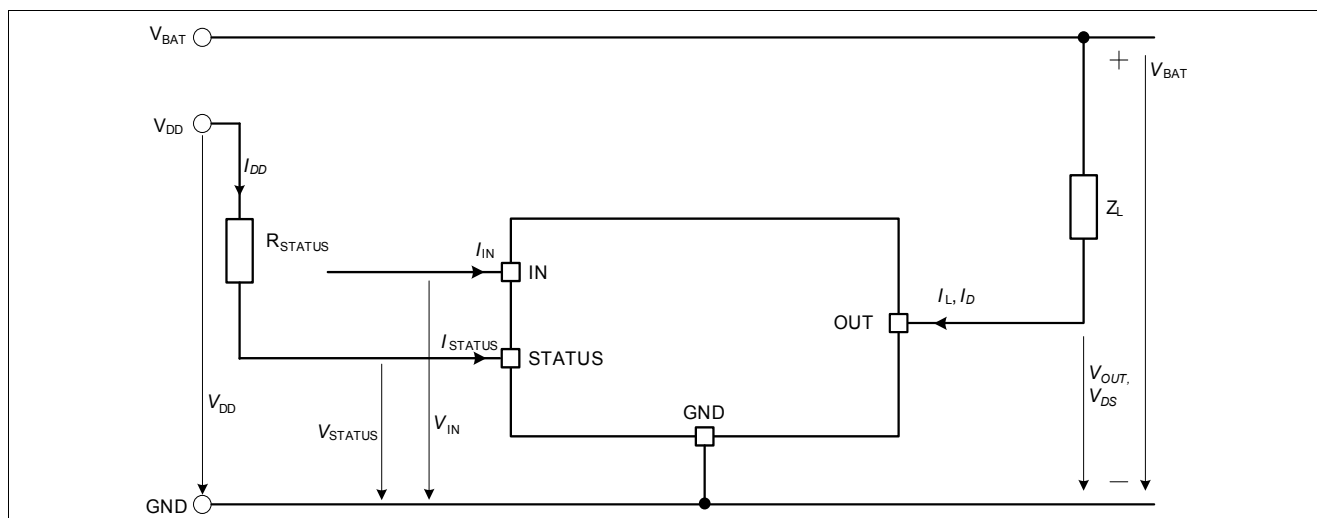

Figure 3 Naming definition of electrical parameters

General Product Characteristics

4 General Product Characteristics

4.1 Absolute Maximum Ratings

Table 2 Absolute Maximum Ratings¹⁾

$T_j = -40^\circ\text{C}$ to $+150^\circ\text{C}$; all voltages with respect to ground, positive current flowing into pin (unless otherwise specified)

Parameter	Symbol	Values			Unit	Note or Test Condition	Number
		Min.	Typ.	Max.			
Voltages							
Output voltage	V_{OUT}	–	–	40	V	internally clamped	P_4.1.1
Battery voltage for short circuit protection	$V_{\text{BAT(SC)}}$	–	–	31	V	$l = 0$ or 5 m $R_{\text{SC}} = 20 \text{ m}\Omega + R_{\text{Cable}}$ $R_{\text{Cable}} = l * 16 \text{ m}\Omega/\text{m}$ $L_{\text{SC}} = 5 \text{ }\mu\text{H} + L_{\text{Cable}}$ $L_{\text{Cable}} = l * 1 \text{ }\mu\text{H}/\text{m}$ $V_{\text{IN}} = 5 \text{ V}$	P_4.1.2
Battery voltage for load dump protection	$V_{\text{BAT(LD)}}$	–	–	40	V	²⁾ $R_I = 2 \text{ }\Omega$ $R_L = 4.5 \text{ }\Omega$ $t_D = 400 \text{ ms}$ suppressed pulse	P_4.1.4
Input Pin							
Input Voltage	V_{IN}	-0.3	–	5.5	V	–	P_4.1.7
Input current in inverse condition on OUT to GND)	I_{IN}	–	–	2	mA	³⁾ $V_{\text{OUT}} < -0.3 \text{ V}$	P_4.1.10
Status Pin							
Status Voltage	V_{STATUS}	-0.3	–	5.5	V	–	P_4.1.11
Status current	I_{STATUS}	–	–	5	mA	$-0.3 \text{ V} < V_{\text{STATUS}} < 5.5 \text{ V}$	P_4.1.12
Status current in inverse current condition on STATUS	$I_{\text{STATUS_L}}$	-1	–	–	mA	$V_{\text{STATUS}} < -0.3 \text{ V}$	P_4.1.13
Power Stage							
Load current	$ I_L $	–	–	$I_{\text{L(LIM)}}$	A	–	P_4.1.14
Energies							
Unclamped single inductive energy single pulse	E_{AS}	–	–	62	mJ	$I_{\text{L(0)}} = I_{\text{L(NOM)}}$ $V_{\text{BAT}} = 13.5 \text{ V}$ $T_{\text{J(0)}} = 150^\circ\text{C}$	P_4.1.19
Unclamped repetitive inductive energy pulse with 10k	$E_{\text{AR(10k)}}$	–	–	64	mJ	$I_{\text{L(0)}} = I_{\text{L(NOM)}}$ $V_{\text{BAT}} = 13.5 \text{ V}$ $T_{\text{J(0)}} = 105^\circ\text{C}$	P_4.1.31

General Product Characteristics

Table 2 Absolute Maximum Ratings¹⁾ (cont'd)

$T_j = -40^\circ\text{C}$ to $+150^\circ\text{C}$; all voltages with respect to ground, positive current flowing into pin (unless otherwise specified)

Parameter	Symbol	Values			Unit	Note or Test Condition	Number
		Min.	Typ.	Max.			
Unclamped repetitive inductive energy pulse with 100k cycles	$E_{AR(100k)}$	–	–	51	mJ	$I_{L(0)} = I_{L(NOM)}$ $V_{BAT} = 13.5\text{ V}$ $T_{J(0)} = 105^\circ\text{C}$	P_4.1.37
Unclamped repetitive inductive energy pulse with 1M	$E_{AR(1M)}$	–	–	40	mJ	$I_{L(0)} = I_{L(NOM)}$ $V_{BAT} = 13.5\text{ V}$ $T_{J(0)} = 105^\circ\text{C}$	P_4.1.43

Temperatures

Operating temperature	T_J	-40	–	+150	$^\circ\text{C}$	–	P_4.1.52
Storage temperature	T_{STG}	-55	–	+150	$^\circ\text{C}$	–	P_4.1.53

ESD Susceptibility

ESD susceptibility (all pins)	V_{ESD}	-3	–	3	kV	HBM ⁴⁾	P_4.1.54
ESD susceptibility OUT-pin to GND	V_{ESD}	-10	–	10	kV	HBM ⁵⁾	P_4.1.55
ESD susceptibility	V_{ESD}	-1	–	1	kV	CDM ⁶⁾	P_4.1.56
ESD susceptibility non-corner pins	V_{ESD}	-1	–	1	kV	CDM ⁷⁾	P_4.1.57

- 1) Not subject to production test, specified by design.
- 2) $V_{BAT(LD)}$ is setup without the DUT connected to the generator per ISO 7637-1;
 R_l is the internal resistance of the load dump test pulse generator;
 t_D is the pulse duration time for load dump pulse (pulse 5) according ISO 7637-1, -2.
- 3) Maximum allowed value. Consider also inverse input current in inverse condition $I_{IN(-VOUT)}$ in Chapter 9
- 4) ESD susceptibility, HBM according to ANSI/ESDA/JEDEC JS001 (1.5 kV, 100 pF)
- 5) ESD susceptibility, HBM according to ANSI/ESDA/JEDEC JS001 (1.5 kV, 100 pF)
- 6) ESD susceptibility, Charged Device Model “CDM” ESDA STM5.3.1 or ANSI/ESD S.5.3.1
- 7) ESD susceptibility, Charged Device Model “CDM” ESDA STM5.3.1 or ANSI/ESD S.5.3.1

Notes

1. Stresses above the ones listed here may cause permanent damage to the device. Exposure to absolute maximum rating conditions for extended periods may affect device reliability.
2. Integrated protection functions are designed to prevent IC destruction under fault conditions described in the data sheet. Fault conditions are considered as “outside” normal operating range. Protection functions are not designed for continuous repetitive operation.

General Product Characteristics

4.2 Functional Range

Table 3 Functional Range ¹⁾

Please refer to **“Electrical Characteristics” on Page 22** for test conditions

Parameter	Symbol	Values			Unit	Note or Test Condition	Number
		Min.	Typ.	Max.			
Battery Voltage Range for Nominal Operation	$V_{BAT(NOR)}$	6.0	13.5	18.0	V	–	P_4.2.1
Extended Battery Voltage Range for Operation	$V_{BAT(EXT)}$	0	–	31	V	parameter deviations possible	P_4.2.2
Input Voltage Range for Nominal Operation	$V_{IN(NOR)}$	3.0	–	5.5	V	–	P_4.2.3
Junction Temperature	T_J	-40	–	150	°C	–	P_4.2.5

1) Not subject to production test, specified by design

Note: Within the functional range the IC operates as described in the circuit description. The electrical characteristics are specified within the conditions given in the related electrical characteristics table.

General Product Characteristics

4.3 Thermal Resistance

Note: This thermal data was generated in accordance with JEDEC JESD51 standards.
 For more information, go to www.jedec.org.

Table 4 Thermal Resistance PG-TDS08-31

Parameter	Symbol	Values			Unit	Note or Test Condition	Number
		Min.	Typ.	Max.			
Junction to Soldering Point	R_{thJSP}	–	2.7	–	K/W	1) 2)	P_4.3.4
Junction to Ambient (2s2p)	$R_{thJA(2s2p)}$	–	36	–	K/W	1) 3)	P_4.3.10
Junction to Ambient (1s0p+600 mm ² Cu)	$R_{thJA(1s0p)}$	–	46	–	K/W	1) 4)	P_4.3.16
Junction to Ambient (1s0p+300 mm ² Cu)	$R_{thJA(1s0p)}$	–	56	–	K/W	1) 5)	P_4.3.22

- 1) Not subject to production test, specified by design
- 2) Specified R_{thJSP} value is simulated at natural convection on a cold plate setup (all pins are fixed to ambient temperature).
 $T_A = 85^\circ\text{C}$. Device is loaded with 1 W power.
- 3) Specified R_{thJA} value is according to Jedec JESD51-2,-5,-7 at natural convection on FR4 2s2p board; The product (Chip + Package) was simulated on a 76.2 x 114.3 x 1.5 mm board with 2 inner copper layers (2 x 70 μm Cu, 2 x 35 μm Cu). Where applicable a thermal via array under the exposed pad contacted the first inner copper layer.
 $T_A = 85^\circ\text{C}$, Device is loaded with 1 W power.
- 4) Specified R_{thJA} value is according to Jedec JESD51-2,-5,-7 at natural convection on FR4 1s0p board; The product (Chip + Package) was simulated on a 76.2 x 114.3 x 1.5 mm board with additional heatspreading copper area of 600 mm² and 70 μm thickness. $T_A = 85^\circ\text{C}$, Device is loaded with 1 W power.
- 5) Specified R_{thJA} value is according to Jedec JESD51-2,-5,-7 at natural convection on FR4 1s0p board; The product (Chip + Package) was simulated on a 76.2 x 114.3 x 1.5 mm board with additional heatspreading copper area of 300 mm² and 70 μm thickness. $T_A = 85^\circ\text{C}$, Device is loaded with 1 W power.

4.3.1 PCB set up

The following PCB set up was implemented to determine the transient thermal impedance¹⁾

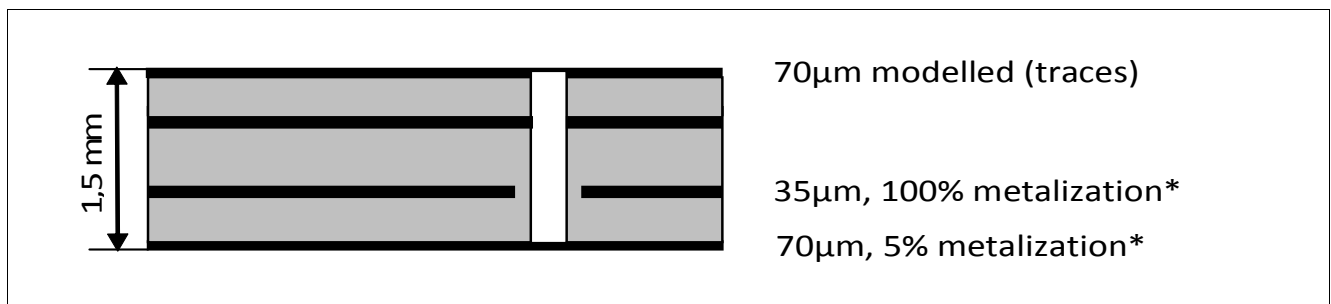

Figure 4 Cross section JEDEC2s2p

1) (*) means percentual Cu metalization on each layer

General Product Characteristics

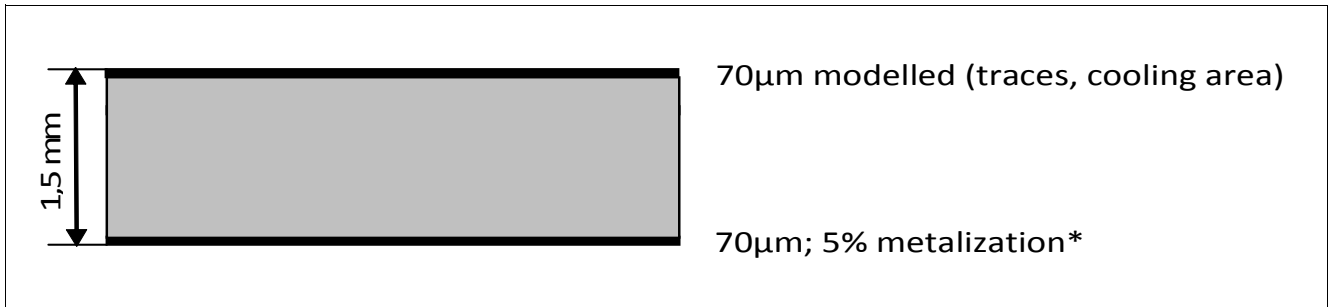

Figure 5 Cross section JEDEC1s0p

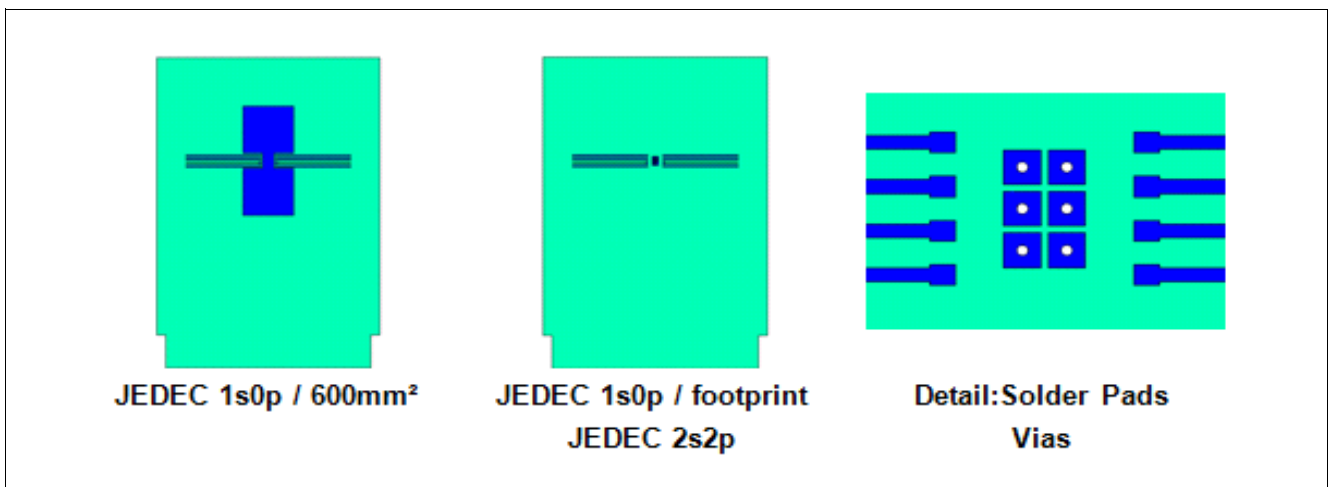

Figure 6 PCB layout

4.3.2 Transient Thermal Impedance

General Product Characteristics

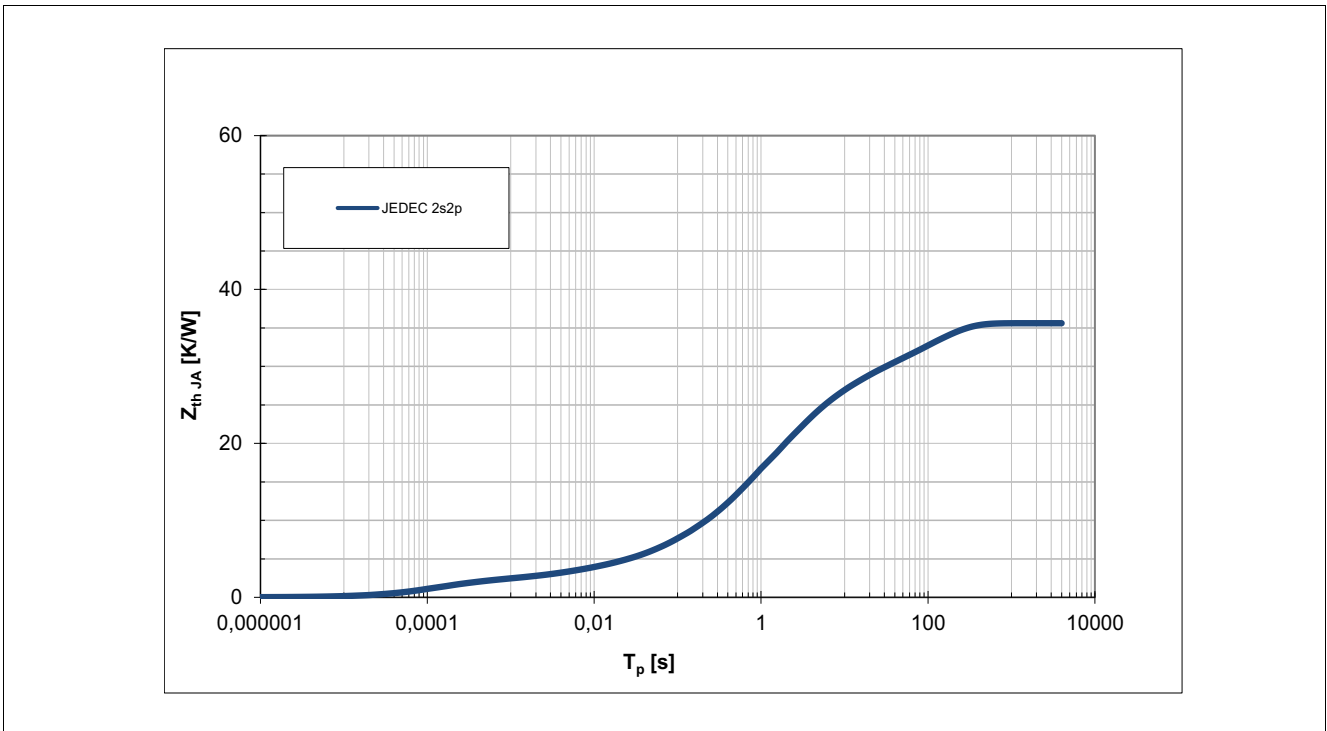

Figure 7 Typical transient thermal impedance $Z_{thJA} = f(t_p)$, $T_A = 85^\circ\text{C}$
Value is according to Jedec JESD51-2,-7 at natural convection on FR4 2s2p board; The product (Chip + Package) was simulated on a $76.2 \times 114.3 \times 1.5 \text{ mm}^3$ board with 2 inner copper layers (2 x $70 \mu\text{m}$ Cu, 2 x $35 \mu\text{m}$ Cu). Device is dissipating 1 W power.

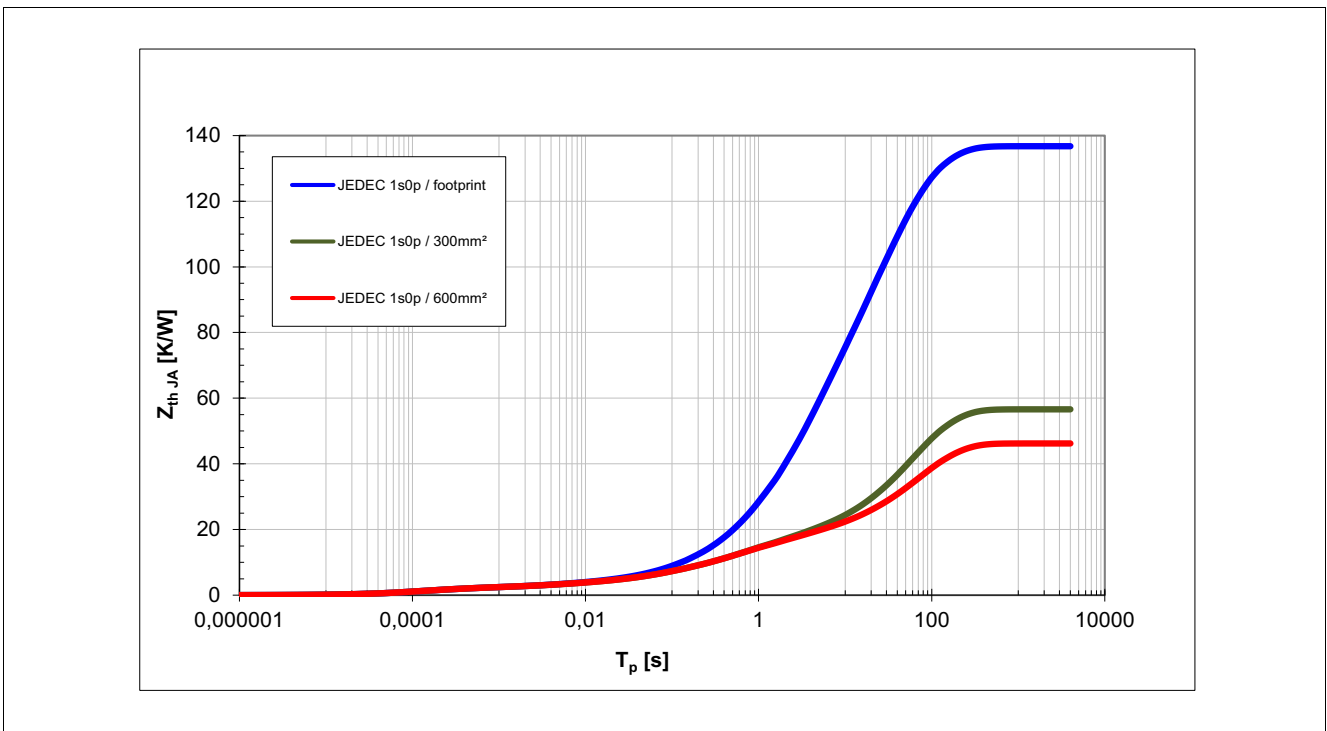

Figure 8 Typical transient thermal impedance $Z_{thJA} = f(t_p)$, $T_a = 85^\circ\text{C}$
Value is according to Jedec JESD51-3 at natural convection on FR4 1s0p board. Device is dissipating 1 W power.

Power Stage

5 Power Stage

5.1 Output On-state Resistance

The on-state resistance depends on the junction temperature T_J . The Figure below show this dependencies in terms of temperature and voltage for the typical on-state resistance $R_{DS(ON)}$. The behavior in reverse polarity is described in [“Reverse Current capability” on Page 16](#)

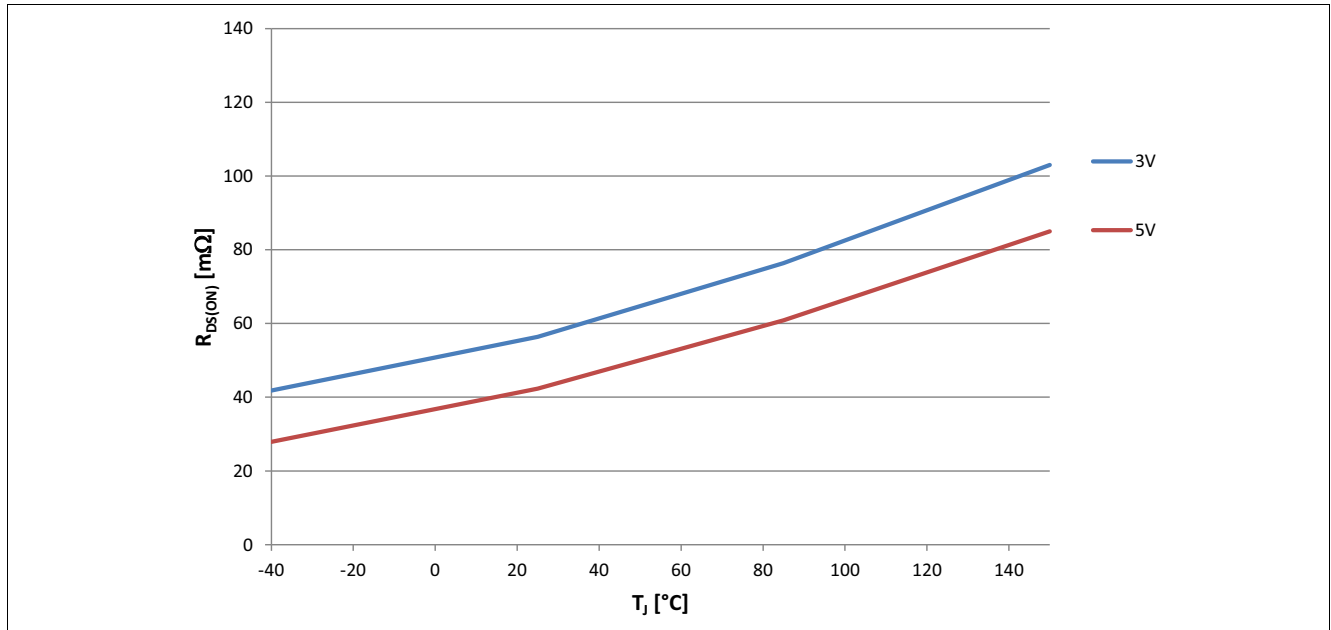

Figure 9 Typical On-State Resistance,
 $R_{DS(ON)} = f(T_J)$, $V_{IN} = 3V$; $V_{IN} = 5V$

5.2 Resistive Load Output Timing

Figure 10 shows the typical timing when switching a resistive load.

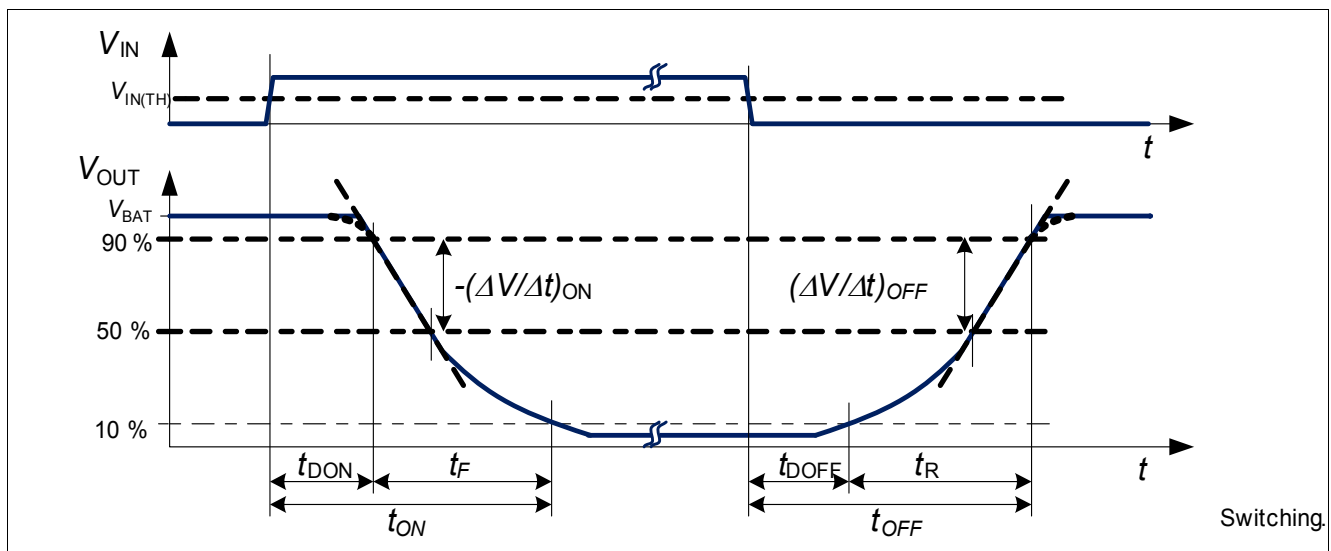

Figure 10 Definition of Power Output Timing for Resistive Load

Power Stage

5.3 Inductive Load

5.3.1 Output Clamping

When switching off inductive loads with low side switches, the Drain-Source voltage V_{OUT} rises above battery potential, because the inductance intends to continue driving the current. To prevent unwanted high voltages the device has a voltage clamping mechanism to keep the voltage at $V_{OUT(CLAMP)}$. During this clamping operation mode the device heats up as it dissipates the energy from the inductance. Therefore the maximum allowed load inductance is limited. See [Figure 11](#) and [Figure 12](#) for more details.

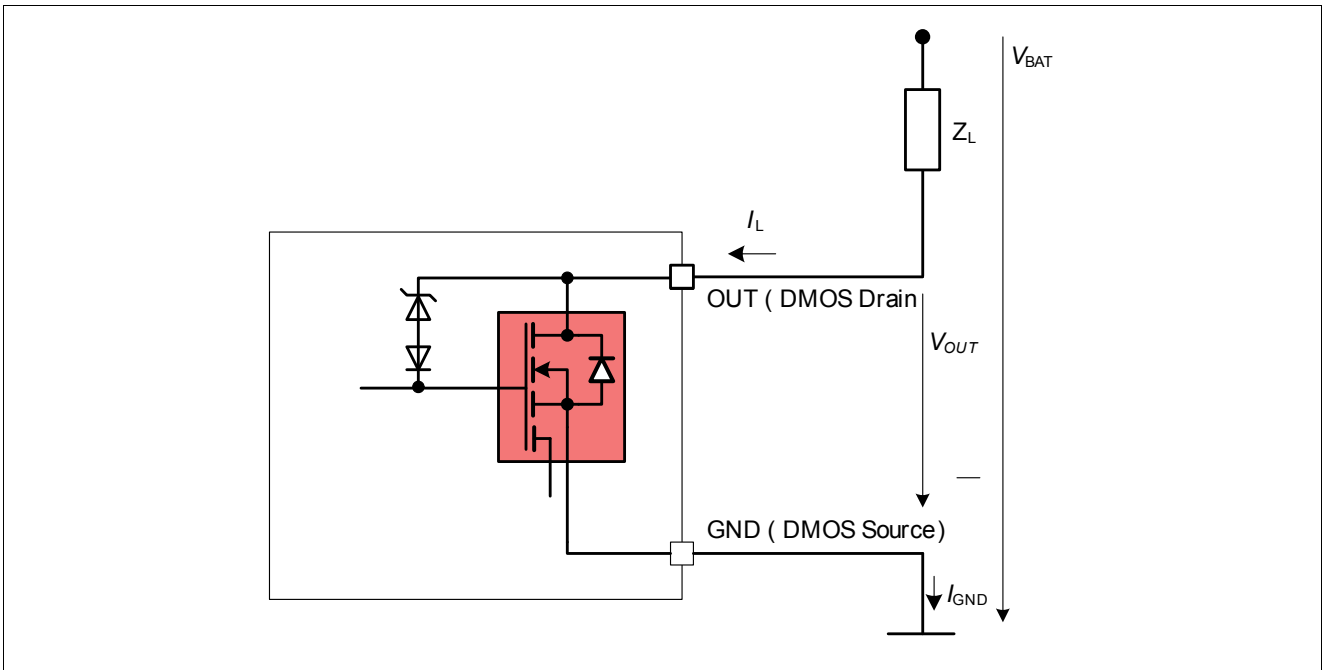

Figure 11 Output Clamp Circuitry

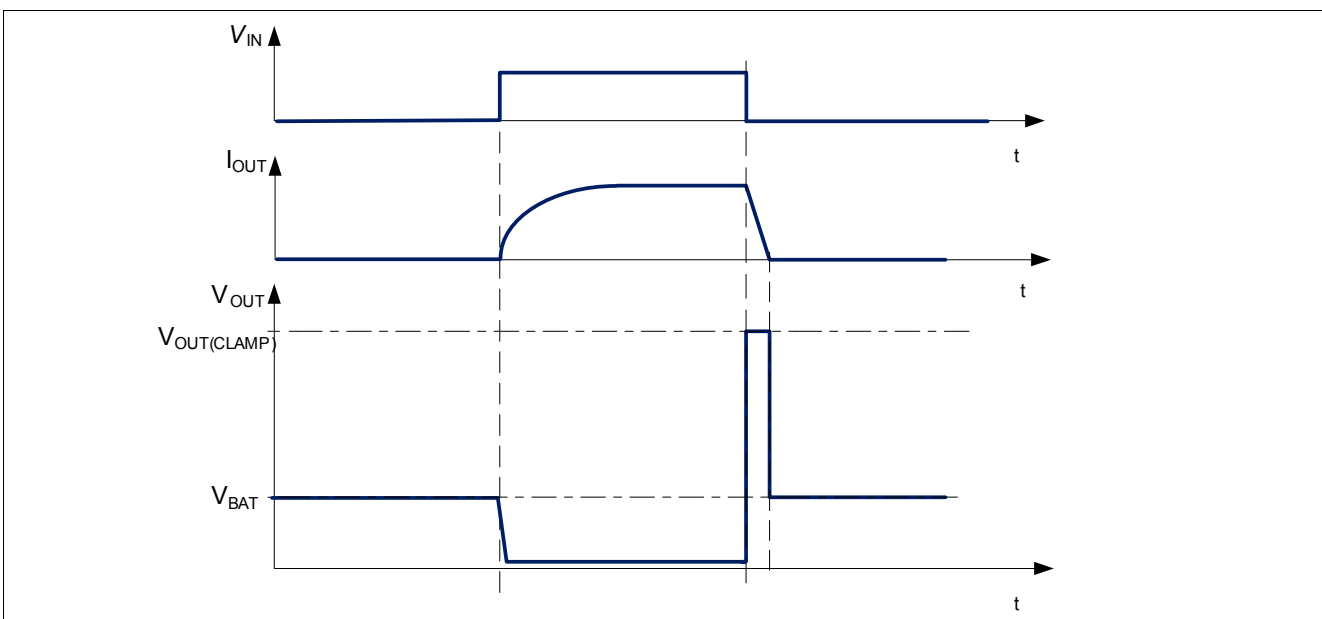

Figure 12 Switching an Inductive Load

Power Stage

5.3.1.1 Maximum Load Inductance

While demagnetization of inductive loads, energy has to be dissipated in the BTS3050EJ. This energy can be calculated by the following equation:

$$E = V_{OUT(CLAMP)} \times \left[\frac{V_{BAT} - V_{OUT(CLAMP)}}{R_L} \times \ln \left(1 - \frac{R_L \times I_L}{V_{BAT} - V_{OUT(CLAMP)}} \right) + I_L \right] \times \frac{L}{R_L} \quad (5.1)$$

Following equation simplifies under assumption of $R_L = 0$

$$E = \frac{1}{2} L I_L^2 \times \left(1 - \frac{V_{BAT}}{V_{BAT} - V_{OUT(CLAMP)}} \right) \quad (5.2)$$

For maximum single avalanche energy please also refer to EAS value in **“Energies” on Page 8**

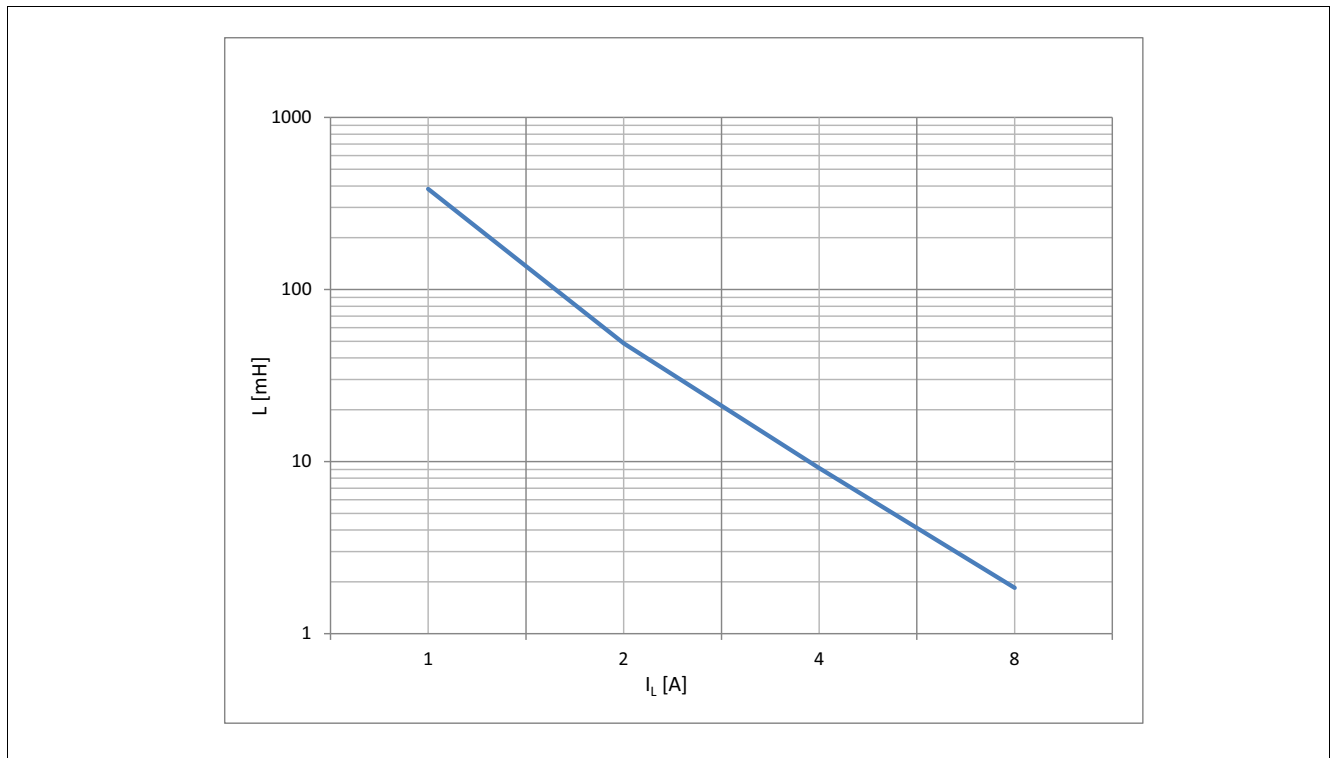

Figure 13 Maximum load inductance for single pulse
 $L = f(I_L), T_{J(0)} = T_{J,start} = 150^\circ\text{C}, V_{BAT} = 13.5\text{ V}$

5.4 Reverse Current capability

A reverse battery situation means the OUT pin is pulled below GND potentials to $-V_{BAT}$ via the load Z_L .

Power Stage

In this situation the load is driven by a current through the intrinsic body diode of the BTS3050EJ. During Reverse Battery all protection functions like current limitation, over temperature shut down and over voltage clamping are not available.

The device is dissipating a power loss which is defined by the driven current and the voltage drop on the DMOS reverse body diode “ $-V_{OUT}$ ”.

5.5 Inverse Current capability

An inverse current situation means the OUT pin is pulled below GND potential by a current flowing from GND to OUT (for example in half-bridge configuration and inductive load using freewheeling via the low side path). In this situation the load is driven by a current through the intrinsic body diode (device off) of the BTS3050EJ. During Inverse operation all protection functions like current limitation, over temperature shut down and over voltage clamping are not available.

The device is dissipating a power loss which is defined by the driven current and the voltage drop on the DMOS reverse body diode “ $-V_{OUT}$ ”.

Input current behavior during inverse condition on Output

Please note that during inverse current on drain an increased input current can flow ($I_{IN(-VOUT)}$). To limit this current it is needed to place a resistor (R_{IN}) in line with the input, also to prevent the microcontroller I/O pins from latching up in this case. The value of this resistor is a compromise of input voltage level in normal operation and maximum allowed device input current I_{IN} or I/O current (for example of microcontroller).

$$R_{IN(\min)} = \frac{V_{OH\mu C(\max)}}{I_{IN(\max)}} \quad (5.3)$$

with $I_{IN(\max)} = 2 \text{ mA}$ (see also **“Absolute Maximum Ratings” on Page 8**) allow for the device;
 $V_{OH\mu C(\max)}$ maximum high level voltage of the control signal (microcontroller I/O)
and assuming $-V_{OUT} = 1.1 \text{ V}$ (worst case) in inverse condition on the output

If inverse current occurs while the STATUS is active (LOW), the STATUS will be reset (HIGH) after the inverse current disappears.

5.6 Characteristics

Please see **“Power Stage” on Page 14** for electrical characteristic table.

Protection Functions

6 Protection Functions

The device provides embedded protection functions. Integrated protection functions are designed to prevent IC destruction under fault conditions described in the datasheet. Fault conditions are considered as “outside” normal operation. Protection functions are not designed for continuous repetitive operation.

6.1 Over Voltage Clamping on OUTPUT

The BTS3050EJ is equipped with a voltage clamp circuitry that keeps the drain-source (output to GND) voltage V_{DS} at a certain level $V_{OUT(CLAMP)}$. The over voltage clamping is overruling the other protection functions. Power dissipation has to be limited to not exceed the maximum allowed junction temperature.

This function is also used in terms of inductive clamping. Please see also [Chapter 5.3.1](#) for more details.

6.2 Thermal Protection

The device is protected against over temperature due to overload and / or bad cooling conditions. To ensure this a temperature sensor is located in the power MOSFET.

The BTS3050EJ has a thermal protection function with automatic restart. After the device has switched off due to over temperature the device will stay off until the junction temperature has dropped down below the thermal hysteresis **“Thermal Protection” on Page 18**.

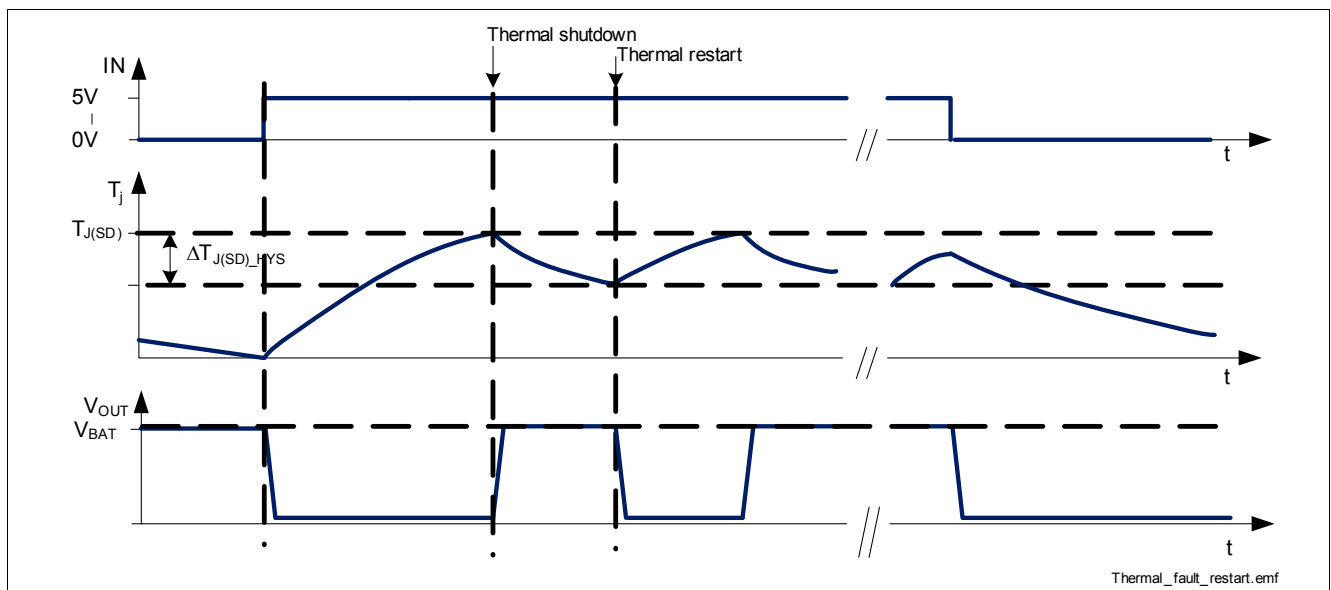

Figure 14 Thermal protective switch OFF scenario with thermal restart

The device also features a digital feedback on the dedicated status pin. This feedback is latched and can be read out easily by the microcontroller. Please see **“Diagnostics” on Page 21** for details on this feedback.

6.3 Short Circuit Protection / Current limitation

The condition short circuit is an overload condition to the device. If the load current reaches the limitation value of $I_{L(LIM)}$ the device limits the current and therefore will start heating up. When the thermal shutdown temperature is reached, the device turns off.

The time from the beginning of current limitation until the over temperature switch off depends strongly on the cooling conditions.

Protection Functions

If input is still high the device will turn on again after the measured temperature has dropped below the thermal hysteresis.

Figure 15 shows this simplified behavior.

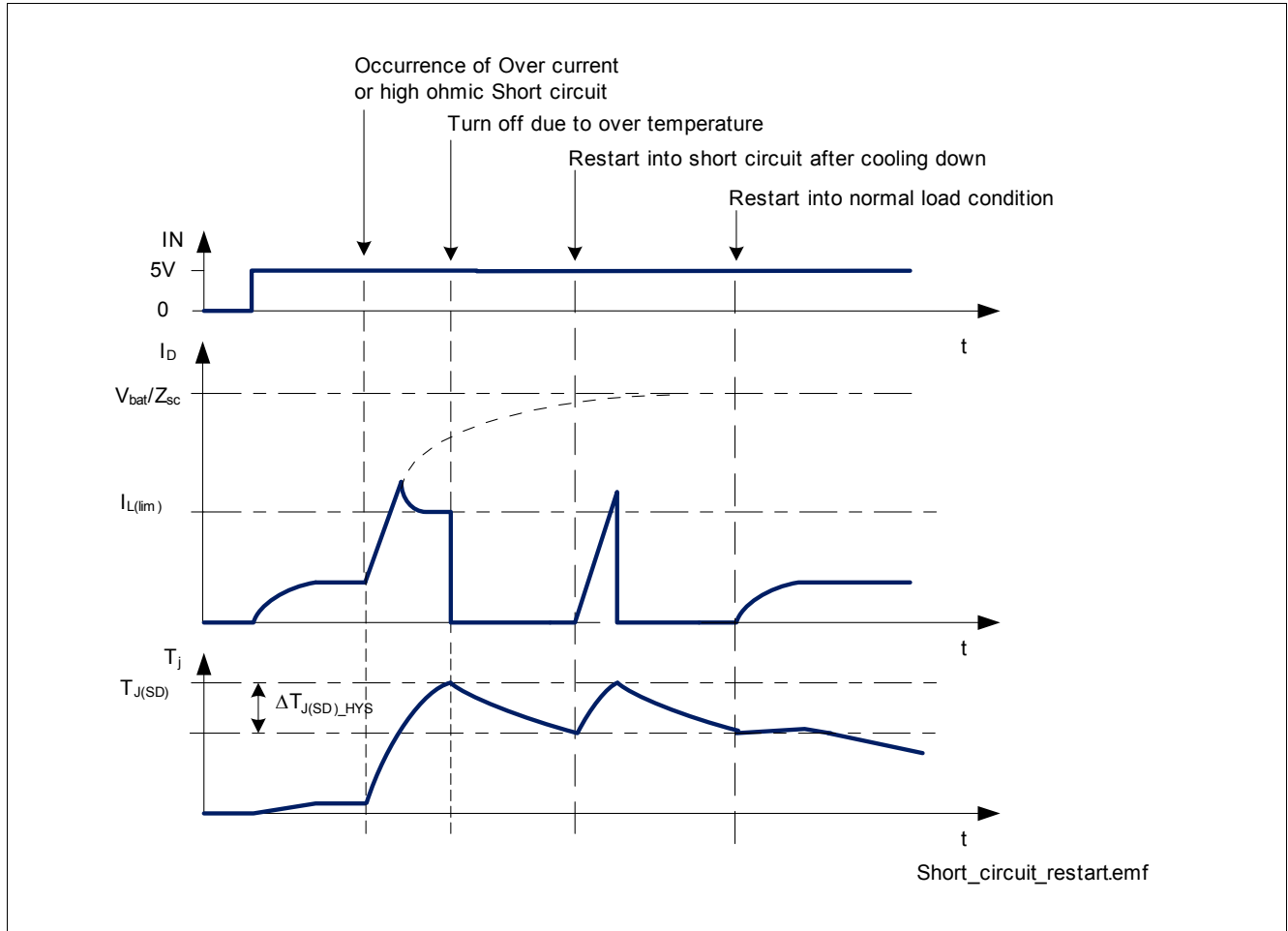

Figure 15 Short circuit protection via current limitation and over temperature switch off with auto-restart

6.4 Characteristics

Please see **“Protection Functions” on Page 18** for electrical characteristic table.

Input Stage

7 Input Stage

7.1 Input Circuit

Figure 16 shows the input circuit of the BTS3050EJ. In case of open or floating input pin the device will automatically switch off and remain off. An ESD Zener structure protects the input circuit against ESD pulses.

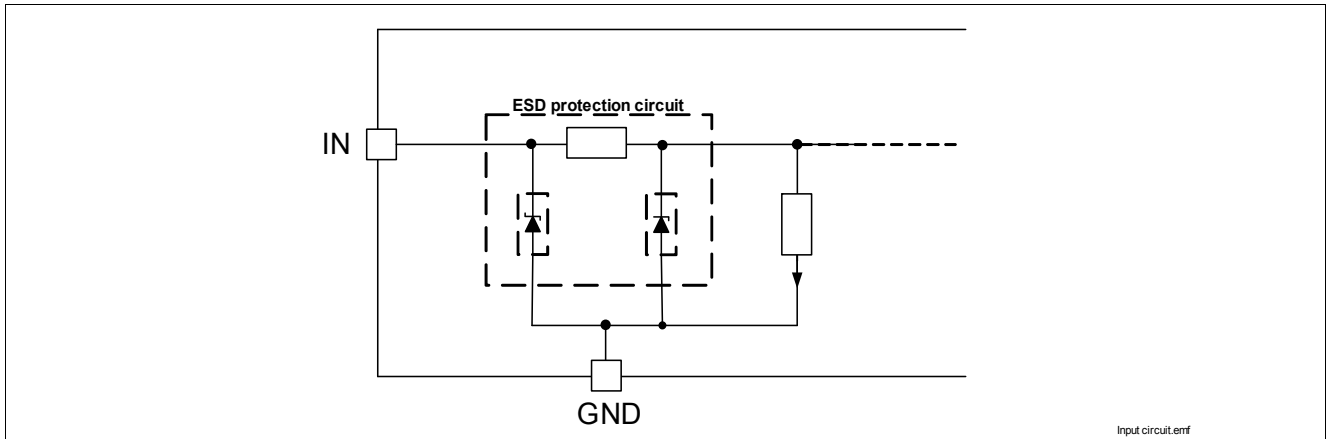

Figure 16 Simplified Input circuitry

7.2 Characteristics

Please see **“Input Stage” on Page 25** for electrical characteristic table.

Diagnostics

8 Diagnostics

The BTS3050EJ provides a latching digital status signal via an open drain style feedback on the STATUS pin. In case of a detected over temperature condition, the device pulls the STATUS pin down to GND (pin) by an internal pull-down intend to signal a low level to the micro controller. This pull-down signal stays active also during thermal restart until the input pin is pulled-down below the input threshold.

In normal operation the status needs to be externally pulled up to a 3 V/5 V supply to signal a high level.

Figure 17 shows this simplified behavior.

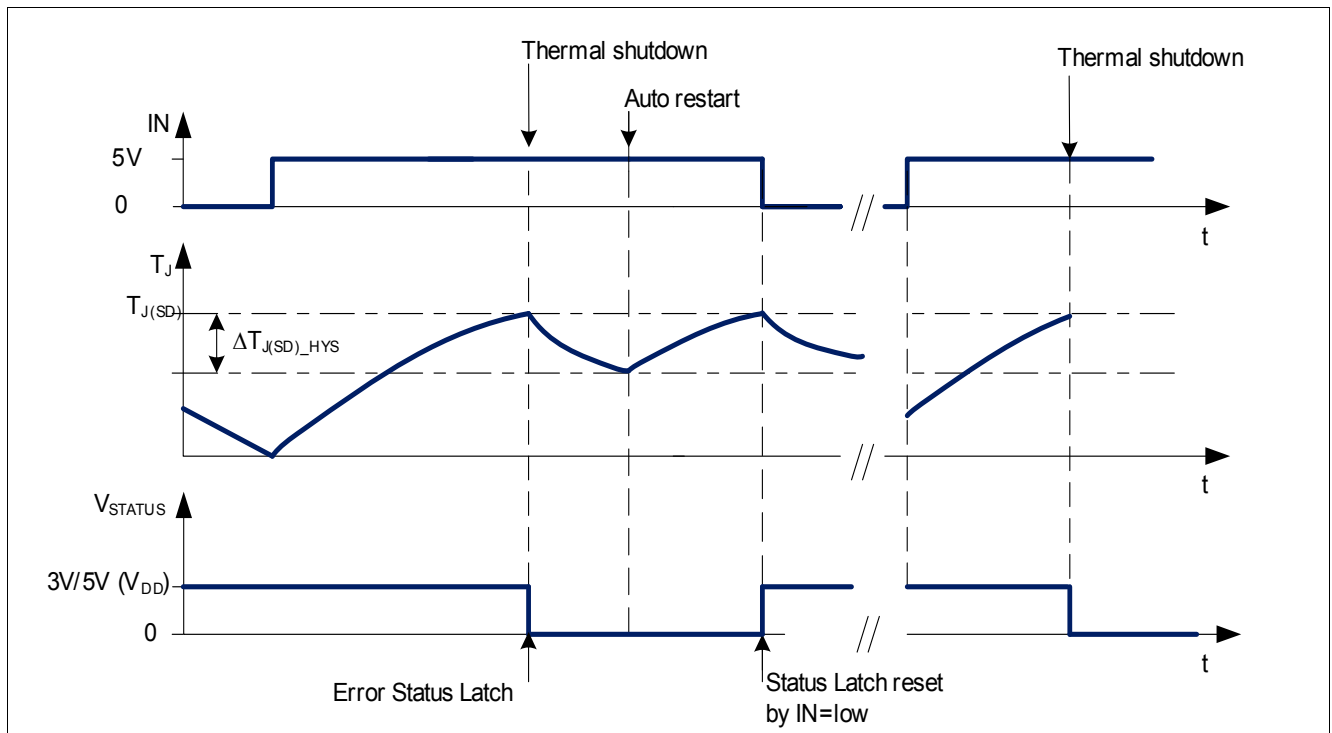

Figure 17 Short circuit protection via current limitation and over temperature switch off with auto-restart and signaling via STATUS pin

Electrical Characteristics

9 Electrical Characteristics

9.1 Power Stage

Please see Chapter **“Power Stage” on Page 14** for parameter description and further details.

Table 5 Electrical Characteristics: Power Stage

$T_j = -40^\circ\text{C}$ to $+150^\circ\text{C}$, $V_{\text{BAT}} = 6\text{ V}$ to 18 V , all voltages with respect to ground, positive current flowing into pin (unless otherwise specified)

Parameter	Symbol	Values			Unit	Note or Test Condition	Number
		Min.	Typ.	Max.			
Power Stage							
On-State resistance at hot temperature (150°C)	$R_{\text{DS(ON)}_{150}}$	–	85	100	mΩ	$T_j = 150^\circ\text{C}$; $V_{\text{IN}} = 5\text{ V}$; $I_L = I_{\text{L(NOM)}}$	P_9.1.4
On-State resistance at ambient temperature (25°C)	$R_{\text{DS(ON)}_{25}}$	–	44	–	mΩ	$T_j = 25^\circ\text{C}$; $V_{\text{IN}} = 5\text{ V}$; $I_L = I_{\text{L(NOM)}}$	P_9.1.10
Nominal load current	$I_{\text{L(NOM)}}$	–	4	–	A	¹⁾ $T_j < 150^\circ\text{C}$; $T_A = 85^\circ\text{C}$ $V_{\text{IN}} = 5\text{ V}$	P_9.1.40
OFF state load current, Output leakage current	$I_{\text{L(OFF)}_{85}}$	–	–	0.6	μA	²⁾ $V_{\text{BAT}} = 13.5\text{ V}$; $V_{\text{IN}} = 0\text{ V}$; $T_j \leq 85^\circ\text{C}$	P_9.1.46
OFF state load current, Output leakage current	$I_{\text{L(OFF)}_{150}}$	–	0.7	2.5	μA	$V_{\text{BAT}} = 18\text{ V}$; $V_{\text{IN}} = 0\text{ V}$; $T_j = 150^\circ\text{C}$	P_9.1.52
Reverse body diode forward voltage	$-V_{\text{OUT}}$	–	0.8	1.1	V	$I_L = -I_{\text{L(NOM)}}$; $V_{\text{IN}} = 0\text{ V}$	P_9.1.67

Electrical Characteristics

Table 5 Electrical Characteristics: Power Stage (cont'd)

$T_j = -40^\circ\text{C}$ to $+150^\circ\text{C}$, $V_{\text{BAT}} = 6\text{ V}$ to 18 V , all voltages with respect to ground, positive current flowing into pin (unless otherwise specified)

Parameter	Symbol	Values			Unit	Note or Test Condition	Number
		Min.	Typ.	Max.			
Dynamic characteristics - switching timesingle pulse $V_{\text{BAT}} = 13.5\text{ V}$, $R_L = 4.7\Omega$; for definition details see Figure 10 “Definition of Power Output Timing for Resistive Load” on Page 14							
Turn-on time	t_{ON}	35	75	115	μs	³⁾ $V_{\text{IN}} = 0\text{ V}$ to 5 V ; $V_{\text{OUT}} = 10\% V_{\text{BAT}}$	P_9.1.68
Turn-off time	t_{OFF}	70	135	210	μs	⁴⁾ $V_{\text{IN}} = 5\text{ V}$ to 0 V ; $V_{\text{OUT}} = 90\% V_{\text{BAT}}$	P_9.1.69
Turn-on delay time	t_{DON}	5	15	25	μs	$V_{\text{IN}} = 0\text{ V}$ to 5 V ; $V_{\text{OUT}} = 90\% V_{\text{BAT}}$	P_9.1.70
Turn-off delay time	t_{DOFF}	40	75	120	μs	$V_{\text{IN}} = 5\text{ V}$ to 0 V ; $V_{\text{OUT}} = 10\% V_{\text{BAT}}$	P_9.1.71
Fall time, Falling output voltage (turn-on)	t_{F}	30	60	90	μs	$V_{\text{IN}} = 0\text{ V}$ to 5 V ; $V_{\text{OUT}} = 90\% V_{\text{BAT}}$ to $V_{\text{OUT}} = 10\% V_{\text{BAT}}$	P_9.1.72
Rise time, Rising output voltage	t_{R}	30	60	90	μs	$V_{\text{IN}} = 5\text{ V}$ to 0 V ; $V_{\text{OUT}} = 10\% V_{\text{BAT}}$ to $V_{\text{OUT}} = 90\% V_{\text{BAT}}$	P_9.1.73
Turn-on Slew rate	$-(\Delta V/\Delta t)_{\text{ON}}$	0.22	0.45	0.65	$\text{V}/\mu\text{s}$	⁵⁾ $V_{\text{OUT}} = 90\% V_{\text{BAT}}$ to $V_{\text{OUT}} = 50\% V_{\text{BAT}}$	P_9.1.74
Turn-off Slew rate	$(\Delta V/\Delta t)_{\text{OFF}}$	0.22	0.45	0.65	$\text{V}/\mu\text{s}$	⁶⁾ $V_{\text{OUT}} = 50\% V_{\text{BAT}}$ to $V_{\text{OUT}} = 90\% V_{\text{BAT}}$	P_9.1.75

1) Not subject to production test, calculated by R_{thJA} (JEDEC 2s2p, PCB) and $R_{\text{DS(ON)}}$

2) Not subject to production test, specified by design;

3) Not subject to production test, calculated with delay time ON and fall time

4) Not subject to production test, calculated with delay time OFF and rise time

5) Not subject to production test, calculated slew rate between 90% and 50% V_{OUT}

6) Not subject to production test, calculated slew rate between 50% and 90% V_{OUT}

Electrical Characteristics

9.2 Protection

Please see Chapter “**Protection Functions**” on Page 18 for parameter description and further details.

Note: Integrated protection functions are designed to prevent IC destruction under fault conditions described in the data sheet. Fault conditions are considered as “outside” normal operating range. Protection functions are not designed for continuous repetitive operation

Table 6 Electrical Characteristics: Protection

$T_j = -40^{\circ}\text{C}$ to $+150^{\circ}\text{C}$, $V_{\text{BAT}} = 6\text{ V}$ to 18 V , all voltages with respect to ground, positive current flowing into pin (unless otherwise specified)

Parameter	Symbol	Values			Unit	Note or Test Condition	Number
		Min.	Typ.	Max.			
Thermal Protection							
Thermal shut down junction temperature	$T_{\text{J(SD)}}$	150	175	–	$^{\circ}\text{C}$	¹⁾ $3\text{ V} < V_{\text{IN}} < 5.5\text{ V}$	P_9.2.1
Thermal hysteresis	$\Delta T_{\text{J_HYS}}$	–	15	–	K	¹⁾	P_9.2.3
Minimum status latch reset time	t_{RESET}	50	–	–	μs	^{1) 2)} $V_{\text{IN}} < 0.8\text{ V};$	P_9.2.8
Overvoltage Protection							
Drain clamp voltage	$V_{\text{OUT(CLAMP)}}$	40	45	–	V	$V_{\text{IN}} = 0\text{ V};$ $I_{\text{L}} = 10\text{ mA}$	P_9.2.12
Current limitation (see also Figure 15)							
Current limitation	$I_{\text{L(LIM)}}$	15	22.5	30	A	$V_{\text{IN}} = 5\text{ V}$	P_9.2.18

1) Not subject to production test, specified by design.

2) Minimum time needed to reset the STATUS latch feedback signal

Electrical Characteristics

9.3 Input Stage

Please see Chapter “**Input Stage**” on **Page 20** for description and further details.

Table 7 Electrical Characteristics: Input

$T_j = -40^\circ\text{C}$ to $+150^\circ\text{C}$, $V_{\text{BAT}} = 6\text{ V}$ to 18 V , all voltages with respect to ground, positive current flowing into pin (unless otherwise specified)

Parameter	Symbol	Values			Unit	Note or Test Condition	Number
		Min.	Typ.	Max.			
Input							
Input Current, normal ON state	$I_{\text{IN(ON)}}$	–	82	120	μA	$V_{\text{IN}} = 5.0\text{ V}$;	P_9.3.1
Input Current, protection mode	$I_{\text{IN(PROT)}}$	–	184	240	μA	$V_{\text{IN}} = 5.0\text{ V}$;	P_9.3.6
Input current, inverse condition on OUT to GND	$I_{\text{IN(-VOUT)}}$	–	15	–	mA	1) 2) $V_{\text{OUT}} < -0.3\text{ V}$; $-0.3\text{ V} \leq V_{\text{IN}} < 5.5\text{ V}$	P_9.3.9
Input pull down current	$I_{\text{IN-GND}}$	10	–	–	μA	3) $V_{\text{IN}} = V_{\text{IN(TH)}}$	P_9.3.10
Input Voltage on-threshold	$V_{\text{IN(TH)}}$	0.8	2.3	3	V	$I_{\text{L}} = 1.0\text{ mA}$; Power DMOS active	P_9.3.11

- 1) Not subject to production test, specified by design
- 2) Input current must not exceed the maximum ratings in Chapter 4, P_4.1.10
- 3) Not subject to production test, specified by design

9.4 Diagnostics (STATUS Pin)

Please see Chapter “**Diagnostics**” on **Page 21** for description and further details.

Table 8 Electrical Characteristics: Diagnostics

$T_j = -40^\circ\text{C}$ to $+150^\circ\text{C}$, $V_{\text{BAT}} = 6\text{ V}$ to 18 V , all voltages with respect to ground, positive current flowing into pin (unless otherwise specified)

Parameter	Symbol	Values			Unit	Note or Test Condition	Number
		Min.	Typ.	Max.			
Status pin voltage drop	$V_{\text{STATUS(ON)}}$	–	–	0.65	V	$I_{\text{STATUS}} = 1\text{ mA}$; latched fault; $3\text{ V} \leq V_{\text{IN}} < 5.5\text{ V}$	P_9.4.1
Status pin leakage current (85°C)	$I_{\text{STATUS(OFF)_85}}$	–	1.5	6	μA	1) $V_{\text{STATUS}} \leq 5.5\text{ V}$; $T_j \leq 85^\circ\text{C}$; $3\text{ V} \leq V_{\text{IN}} < 5.5\text{ V}$	P_9.4.2
Status pin leakage current (150°C)	$I_{\text{STATUS(OFF)_150}}$	–	6	12	μA	$V_{\text{STATUS}} \leq 5.0\text{ V}$; $T_j = 150^\circ\text{C}$; $3\text{ V} \leq V_{\text{IN}} < 5.5\text{ V}$	P_9.4.3

- 1) Not subject to production test, specified by design.

Characterization Results

10 Characterization Results

Typical performance characteristics.

10.1 Power Stage

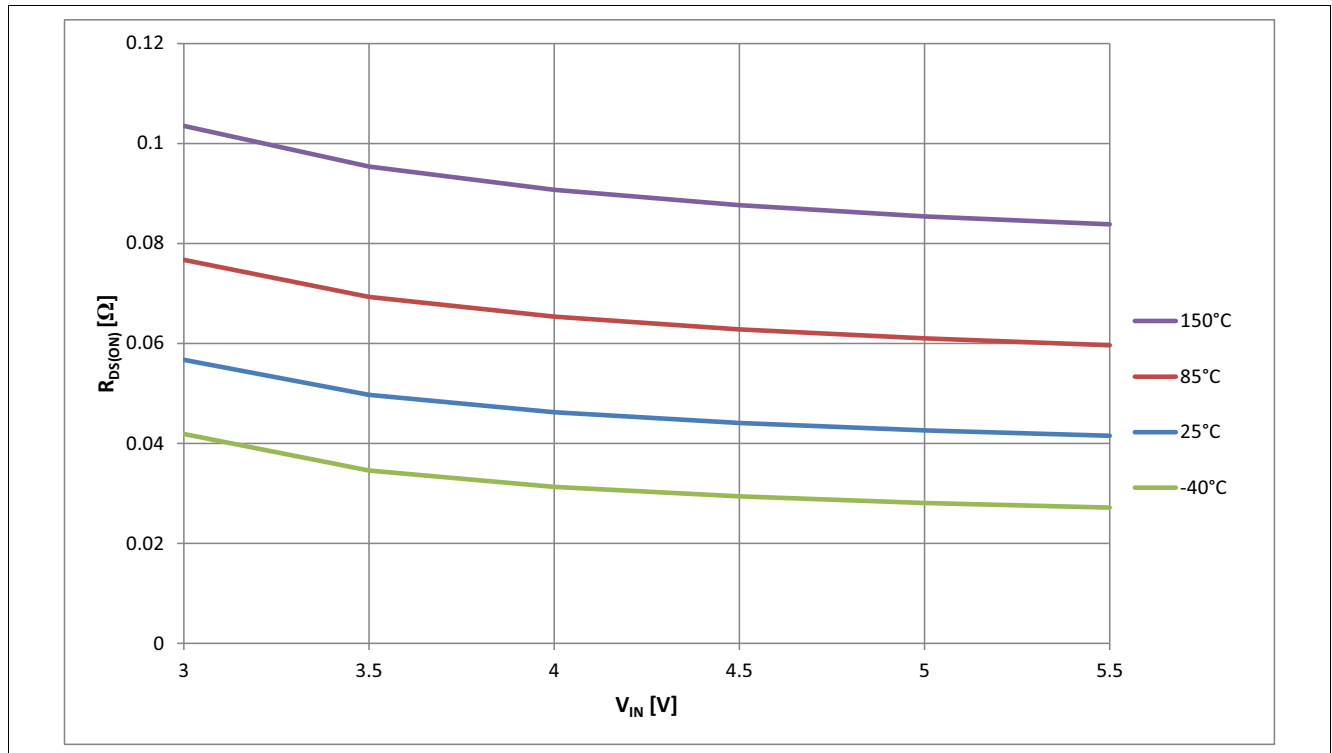

Figure 18 Typical $R_{DS(ON)}$ vs. V_{IN} @ $T_J = -40 \dots 150^\circ\text{C}$, $I_L = I_{L(NOM)}$

Characterization Results

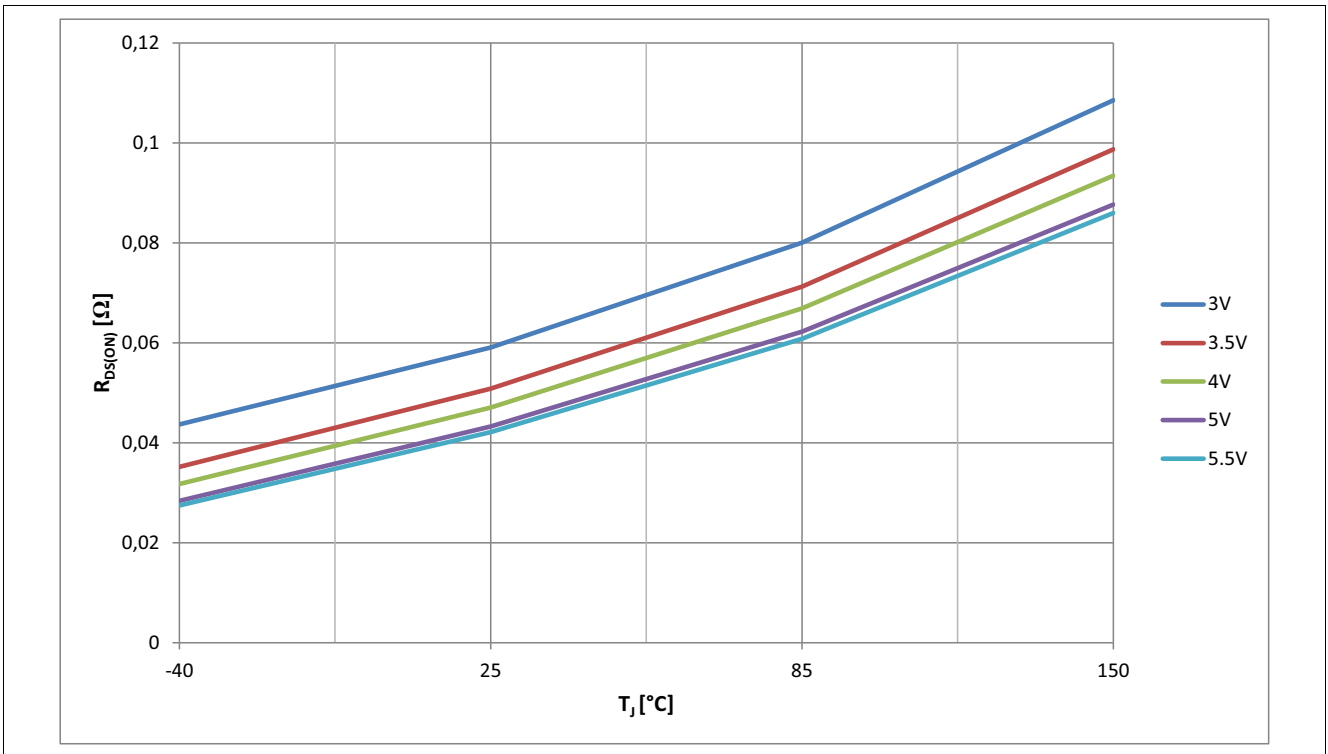

Figure 19 Typical $R_{DS(ON)}$ vs. T_J @ $V_{IN} = 3 \dots 5.5 \text{ V}$; $I_L = I_{L(NOM)}$

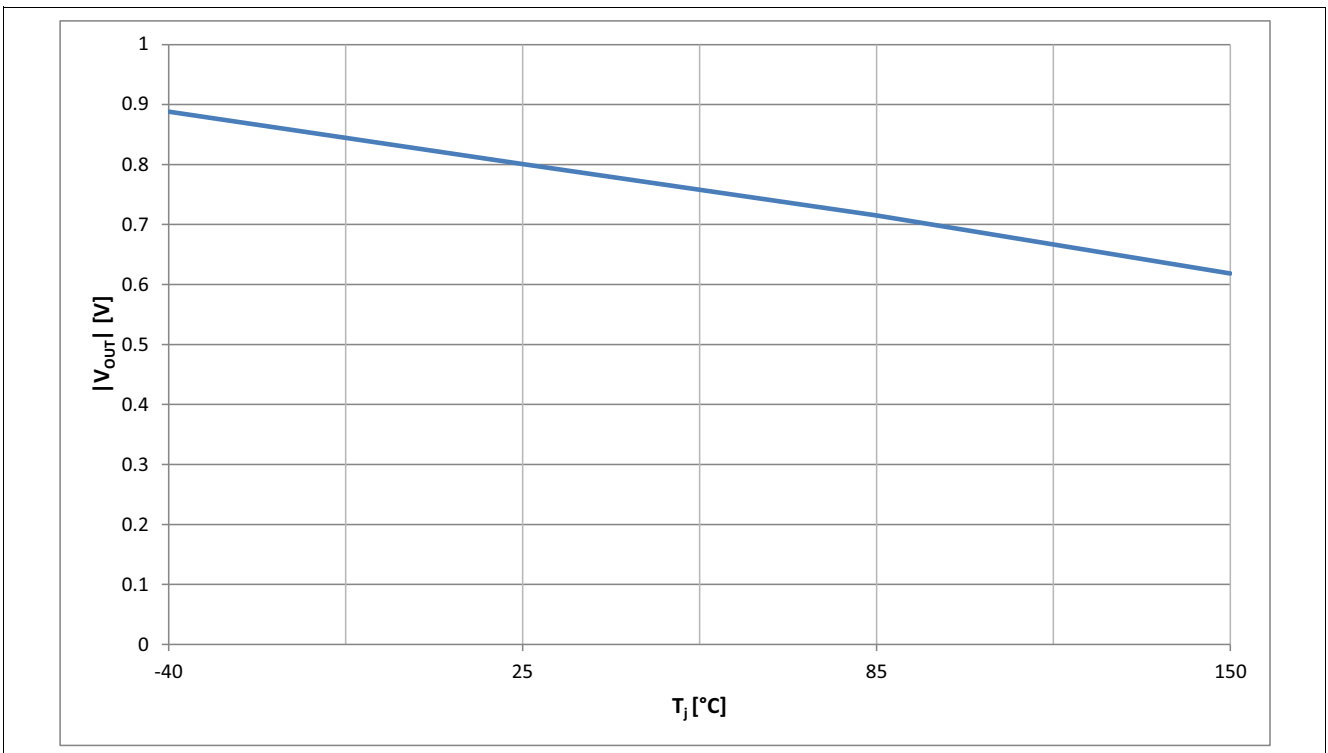

Figure 20 Typical Reverse Diode $|V_{OUT}|$ vs. T_J @ $I_L = -I_{L(NOM)}$

Characterization Results

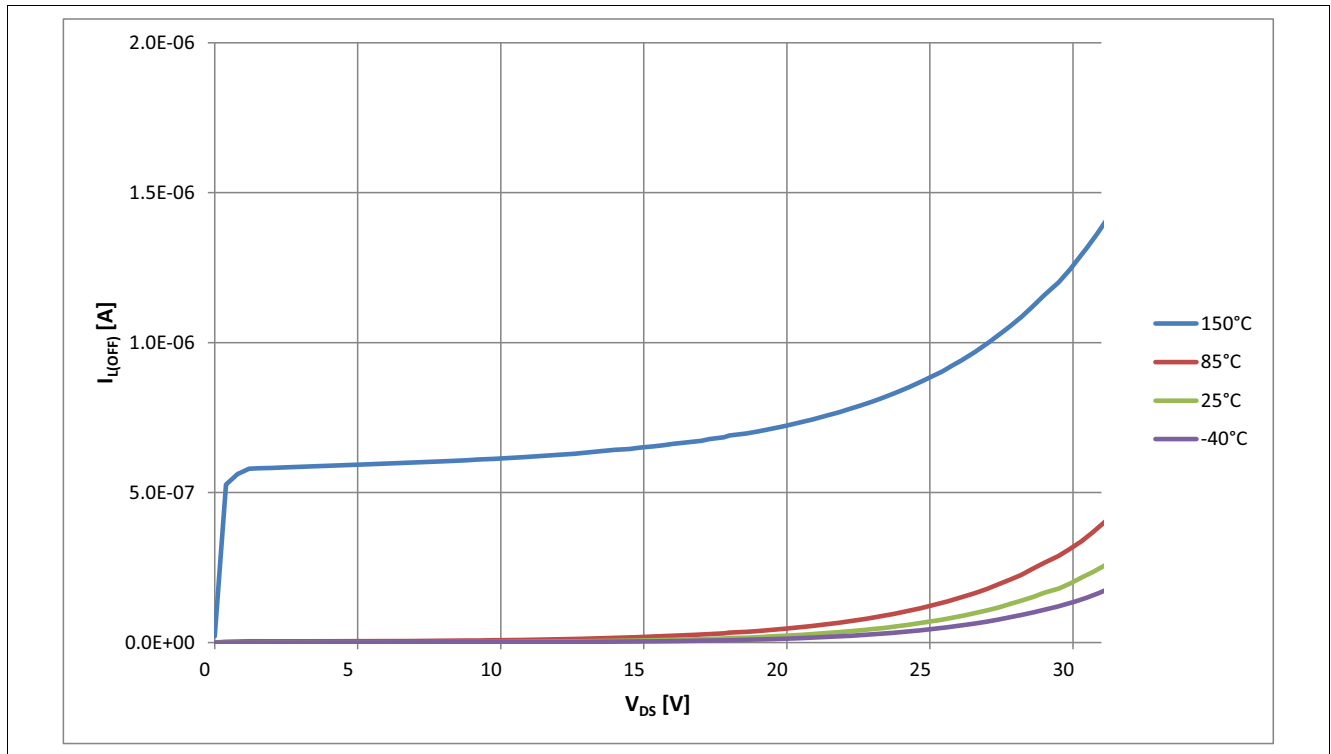

Figure 21 Typical $I_{L(OFF)}$ vs. V_{DS} @ $T_J = -40 \dots 150^\circ\text{C}$, $V_{IN} = 0\text{ V}$

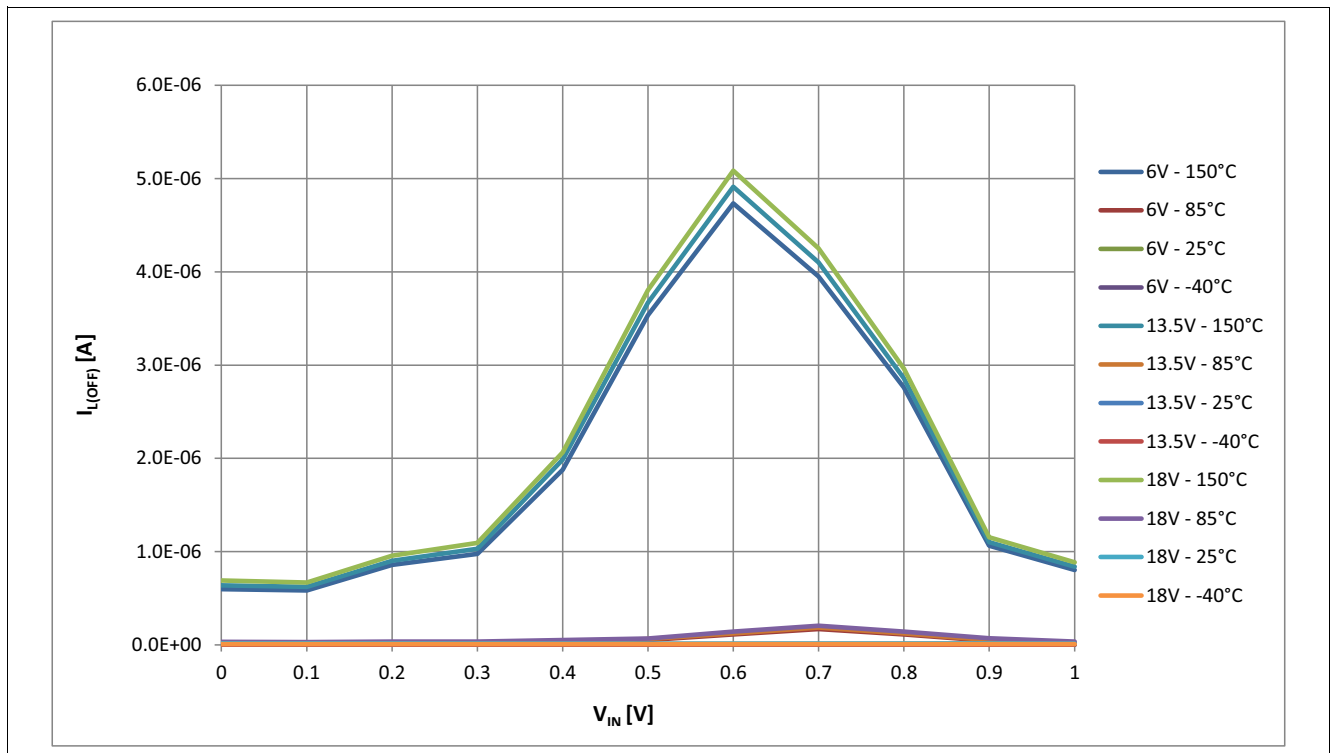

Figure 22 Typical $I_{L(OFF)}$ vs. V_{IN} @ $T_J = -40 \dots 150^\circ\text{C}$, $V_{BAT} = 6 \dots 18\text{ V}$

Characterization Results

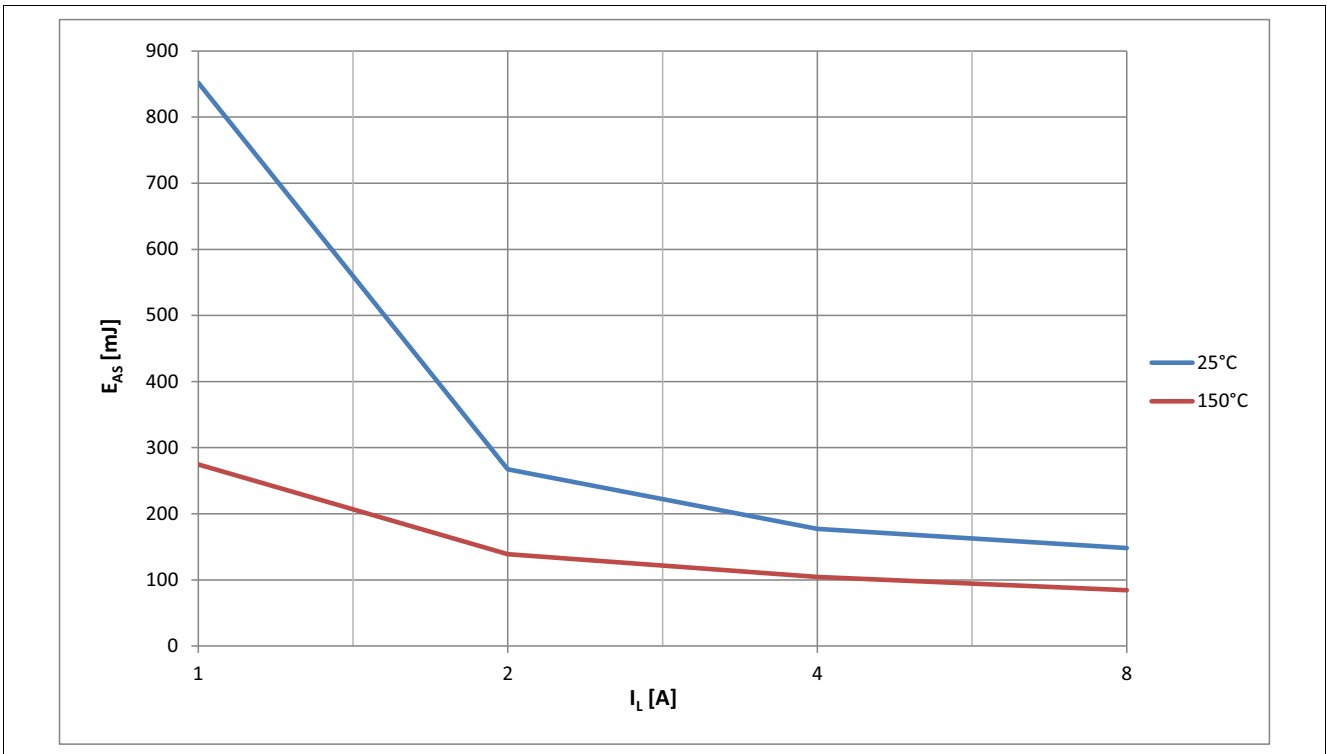

Figure 23 Typical destruction point. E_{AS} vs. I_L @ $T_{J(0)} = 25^\circ\text{C}$ and 150°C , $V_{BAT} = 13.5\text{ V}$

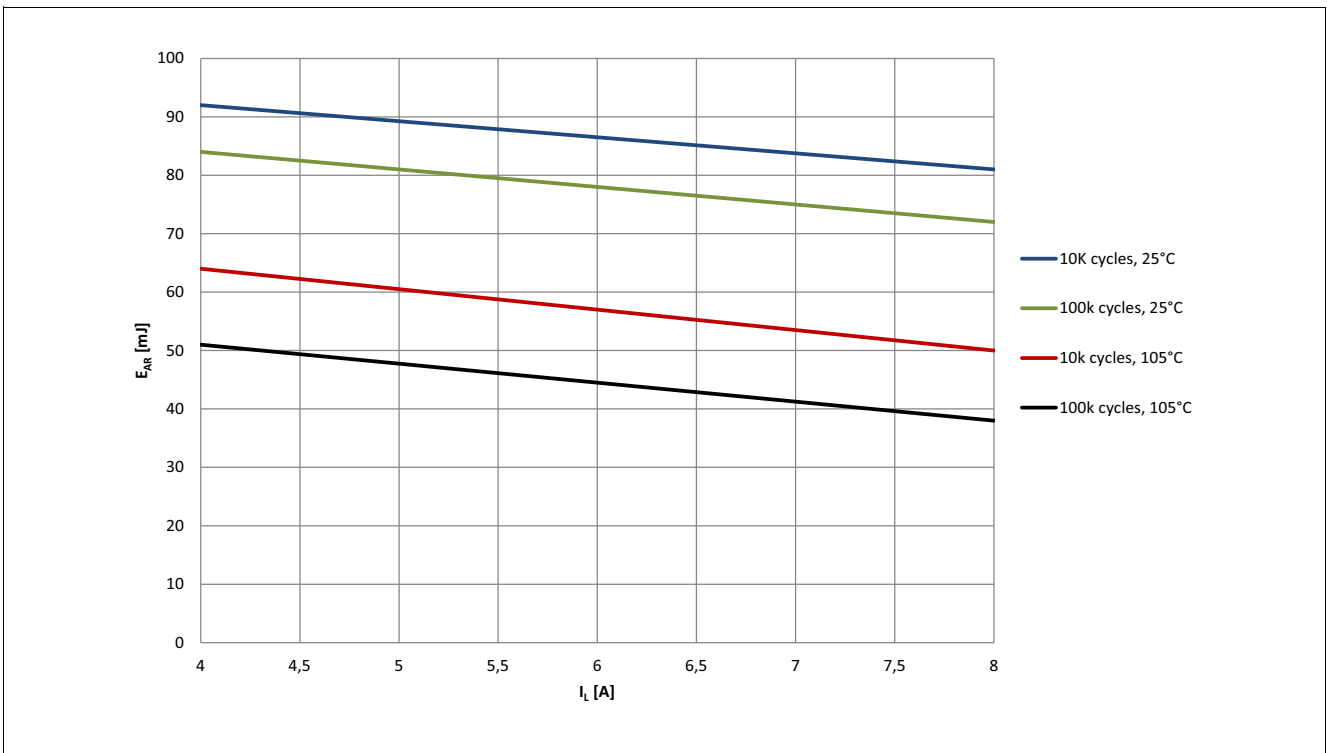

Figure 24 Typical E_{AR} vs. I_L @ $T_{J(0)} = 25^\circ\text{C}$ and 105°C , $V_{BAT} = 13.5\text{ V}$

Characterization Results

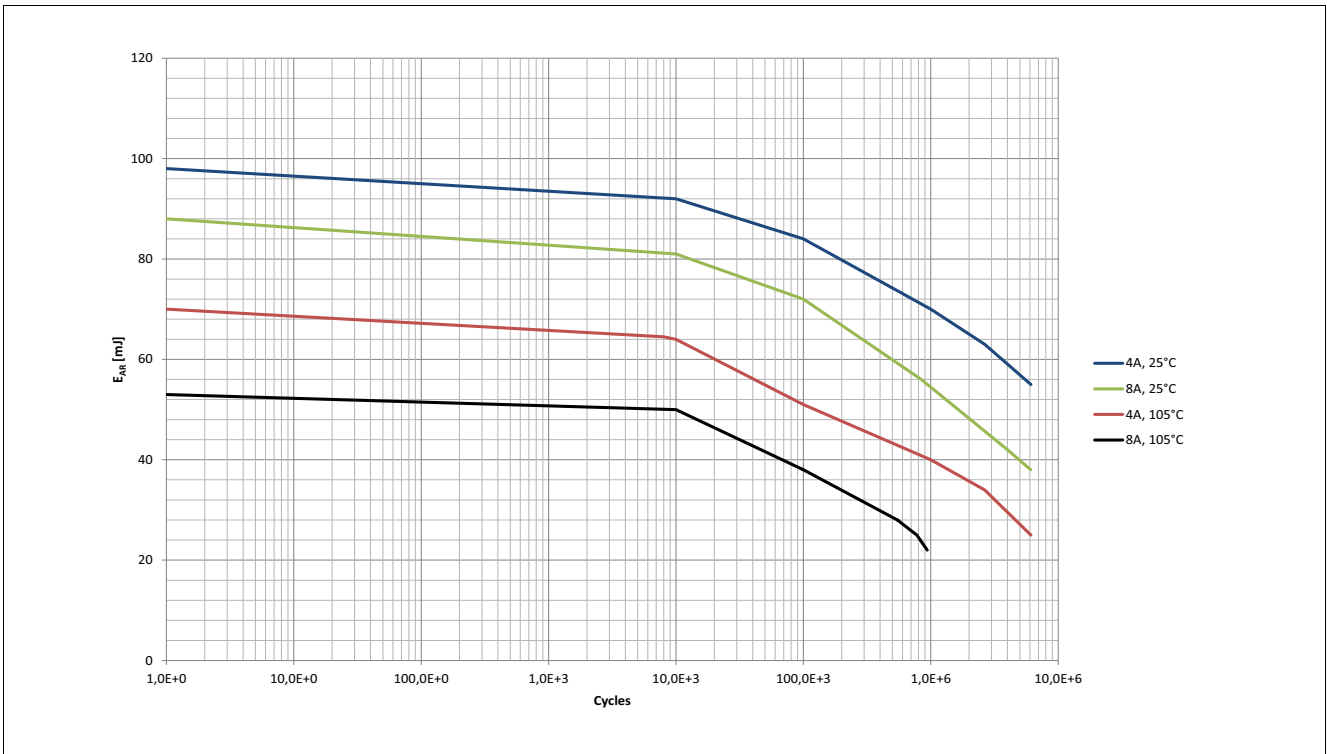

Figure 25 Typical E_{AR} vs. Nr of cycles @ $T_{J(0)} = 25^{\circ}\text{C}$ and 105°C , $V_{BAT} = 13.5\text{ V}$

Dynamic characteristics (switching times):

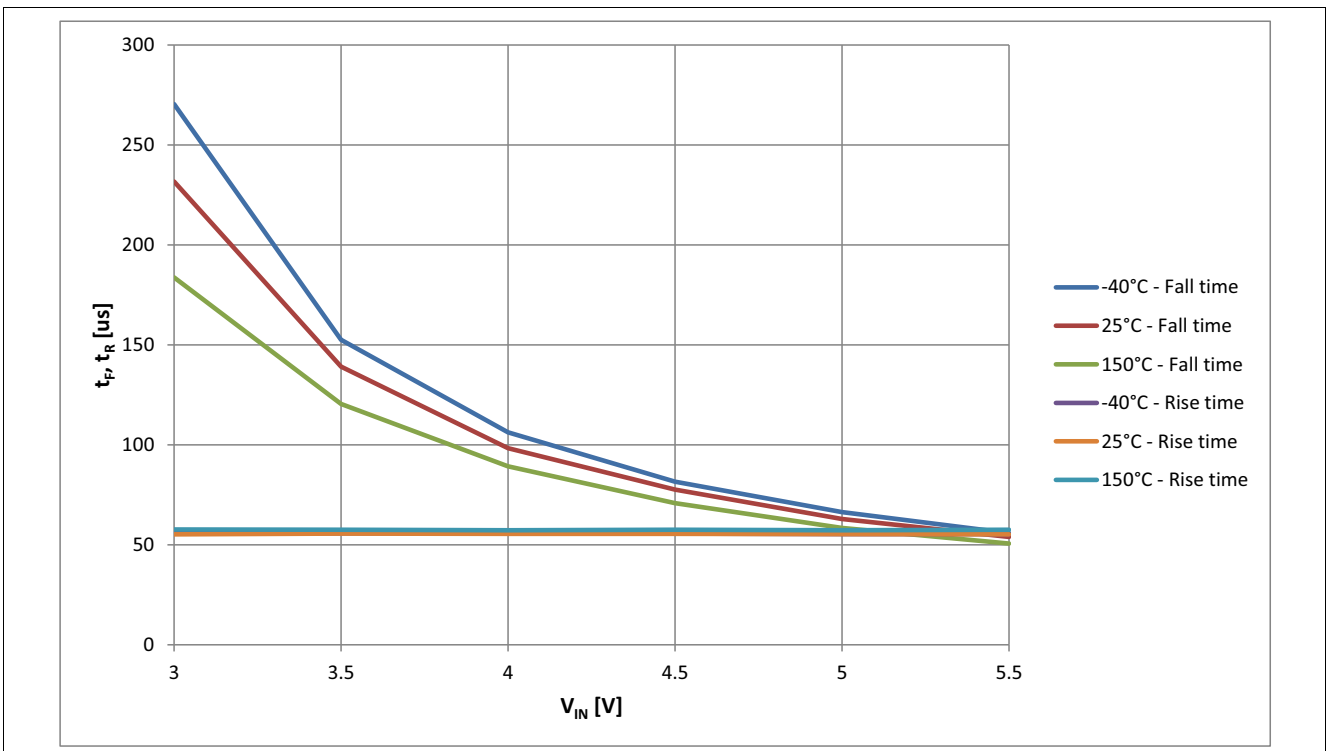

Figure 26 Typical t_F , t_R vs V_{IN} @ $T_J = -40 \dots 150^{\circ}\text{C}$

Characterization Results

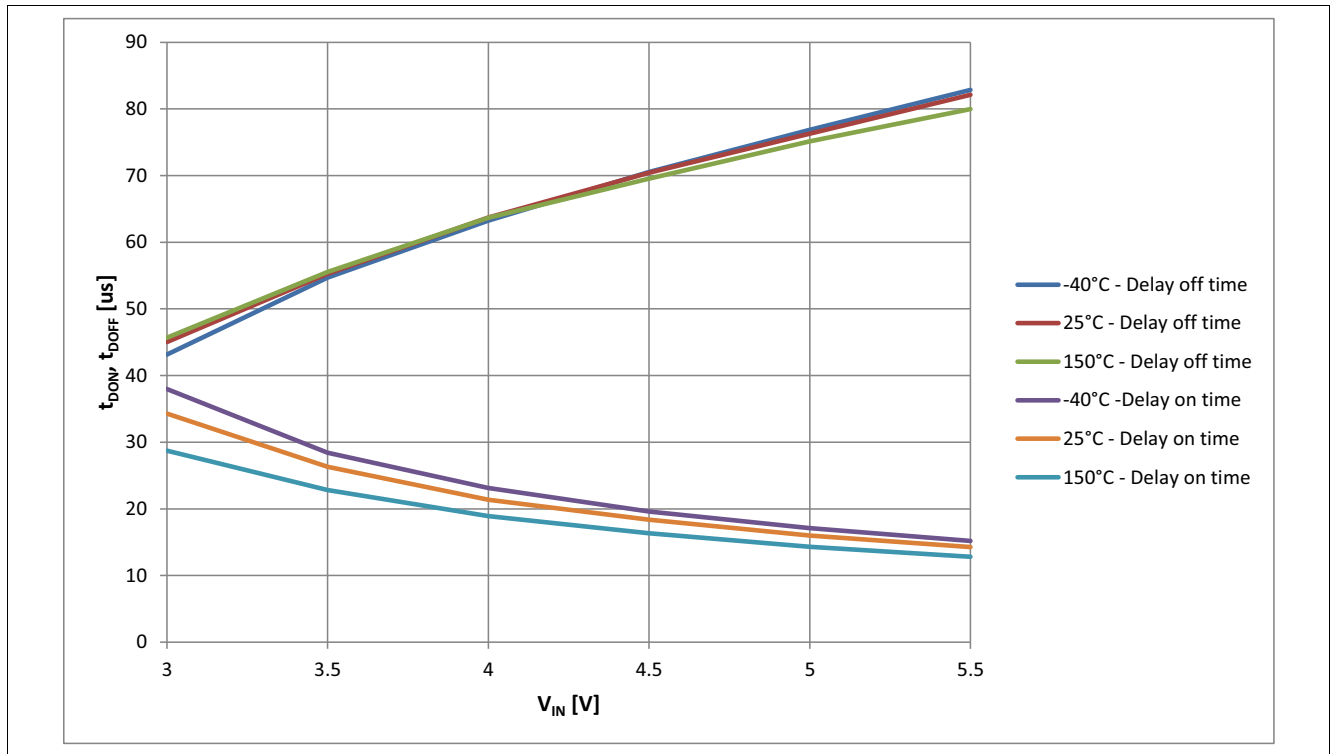

Figure 27 Typical t_{DON} , t_{DOFF} vs V_{IN} @ $T_J = -40 \dots 150^\circ\text{C}$

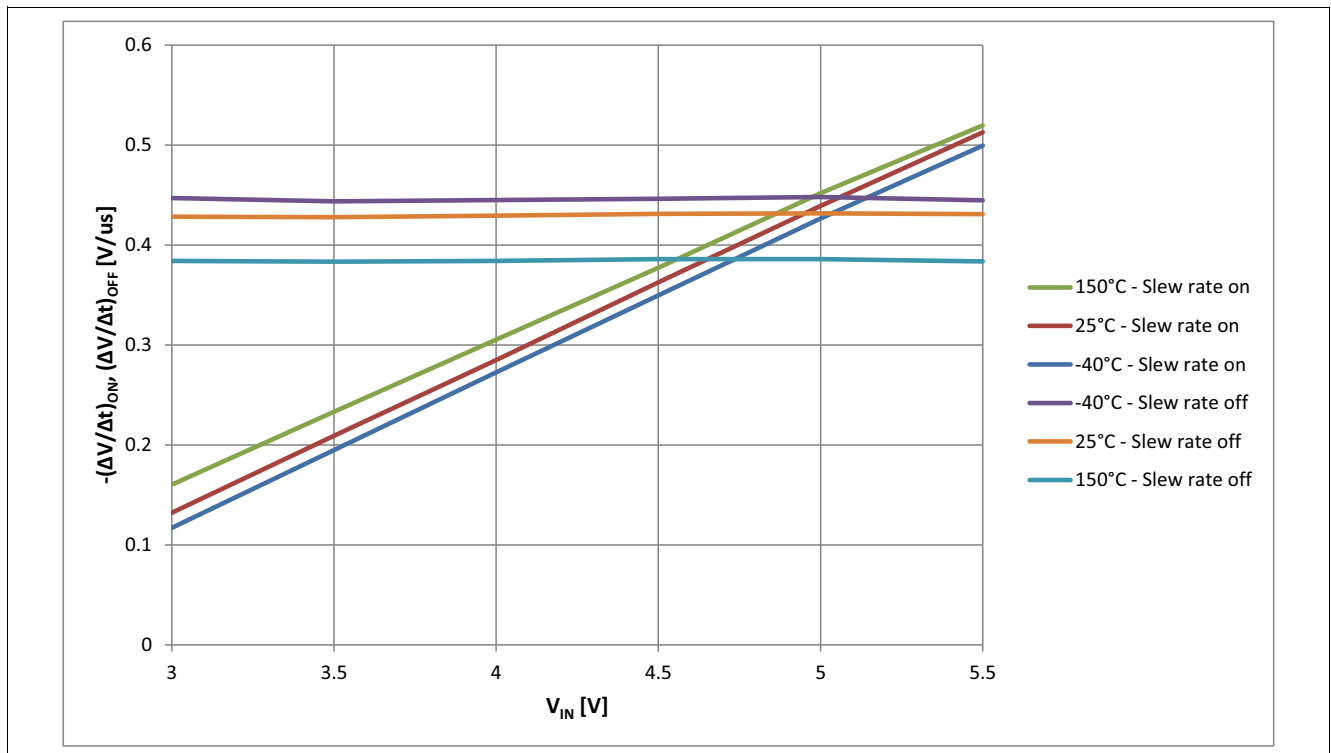

Figure 28 Typical $-(\Delta V/\Delta t)_{ON}$, $(\Delta V/\Delta t)_{OFF}$ vs V_{IN} @ $T_J = -40 \dots 150^\circ\text{C}$

Characterization Results

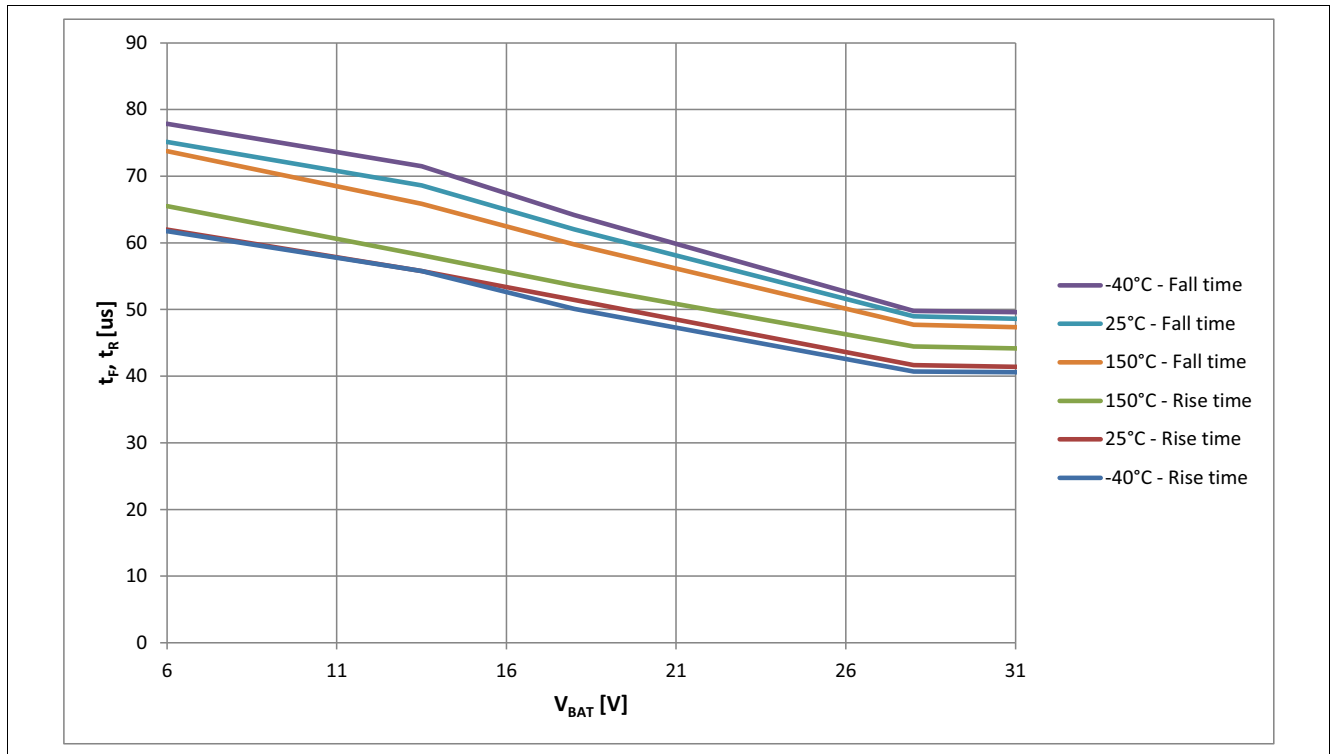

Figure 29 Typical t_F , t_R vs V_{BAT} @ $V_{IN} = 5\text{ V}$, $T_J = -40 \dots 150^\circ\text{C}$

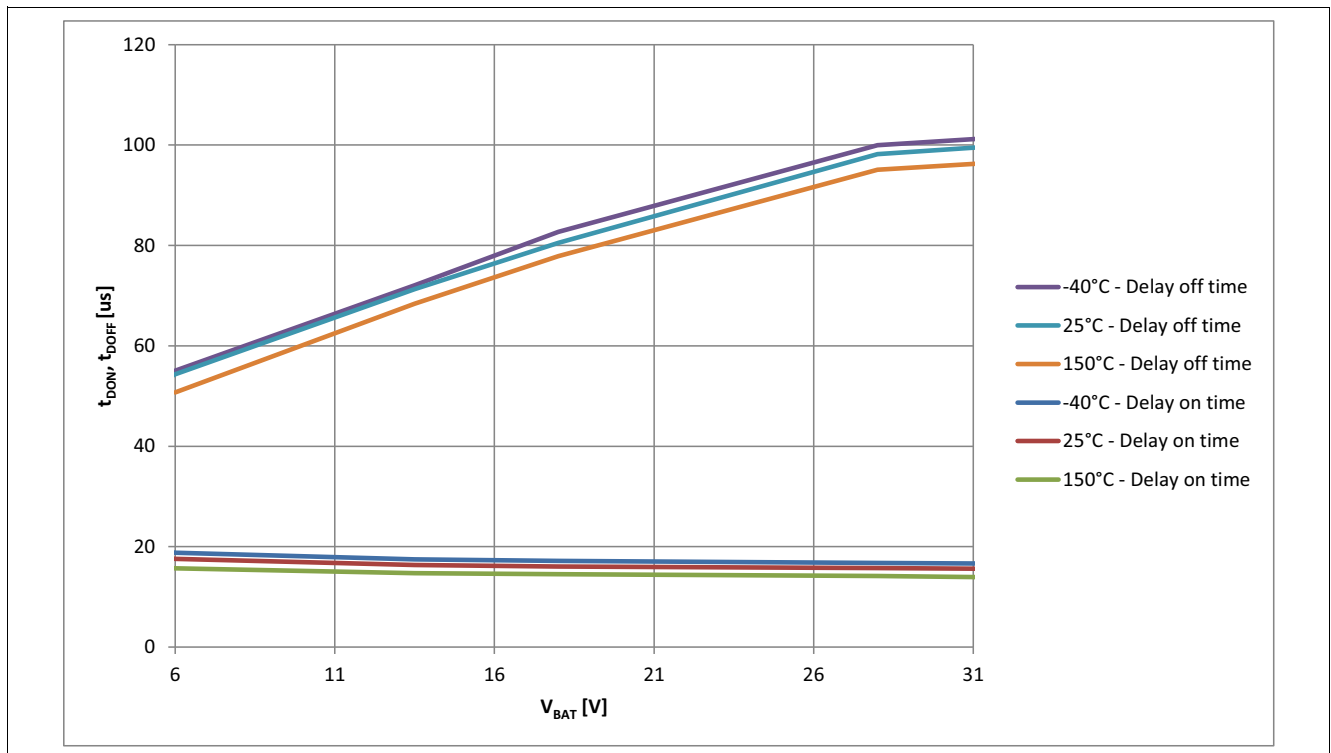

Figure 30 Typical t_{DON} , t_{DOFF} vs V_{BAT} @ $V_{IN} = 5\text{ V}$, $T_J = -40 \dots 150^\circ\text{C}$

Characterization Results

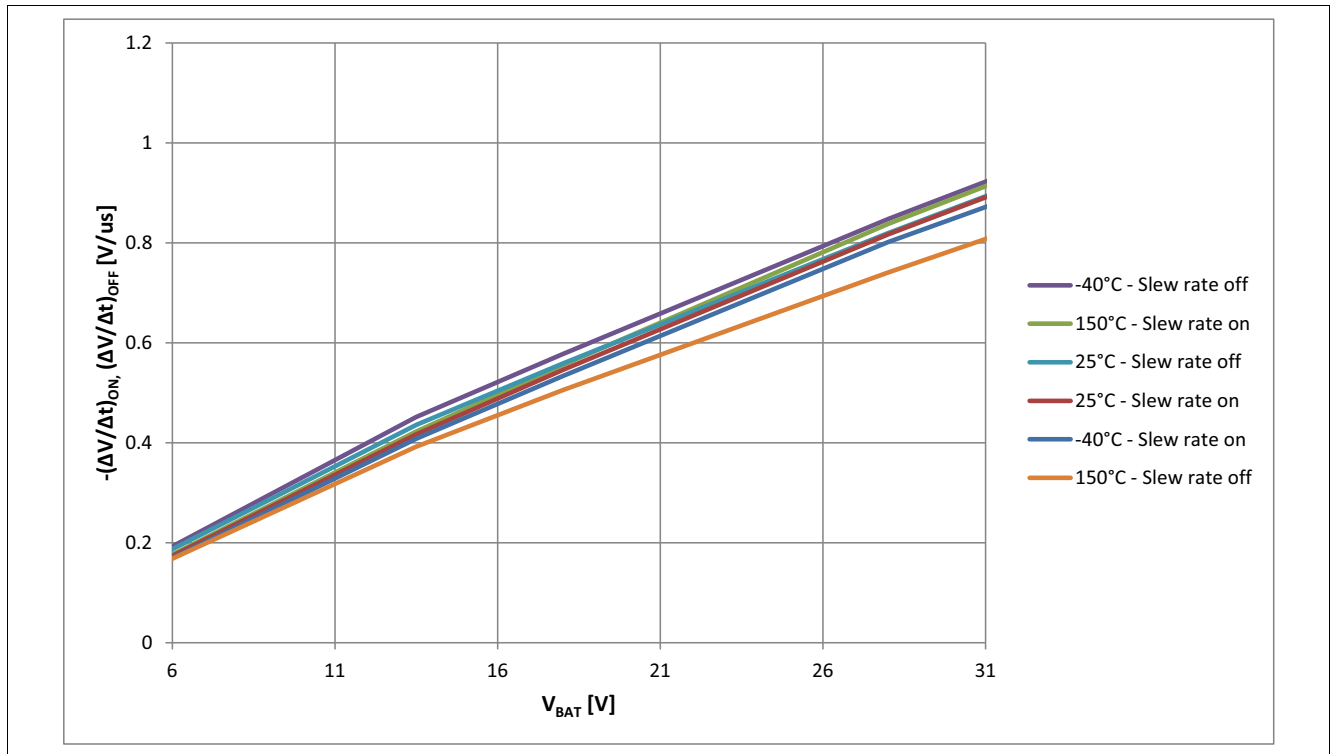

Figure 31 Typical $-(\Delta V/\Delta t)_{ON}$, $(\Delta V/\Delta t)_{OFF}$ vs V_{BAT} @ $V_{IN} = 5\text{ V}$, $T_J = -40 \dots 150^\circ\text{C}$

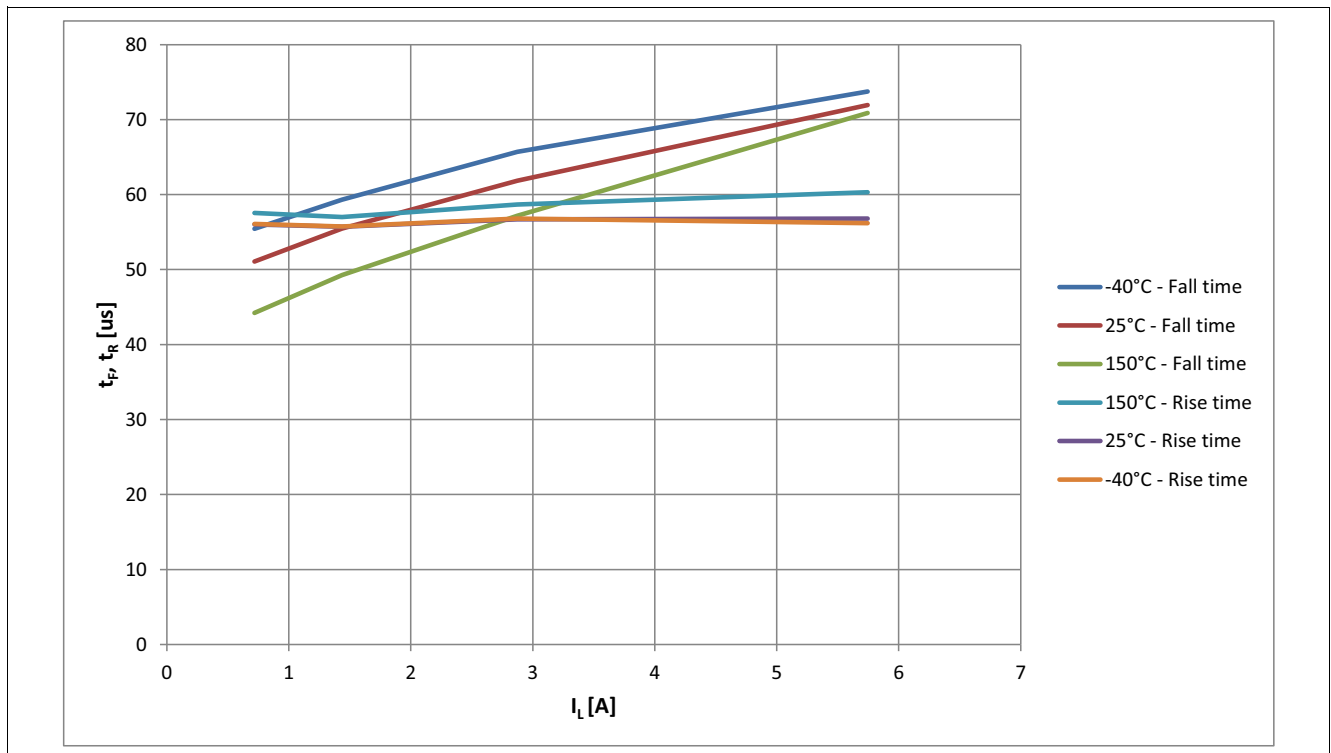

Figure 32 Typical t_F , t_R vs I_L @ $V_{IN} = 5\text{ V}$, $T_J = -40 \dots 150^\circ\text{C}$

Characterization Results

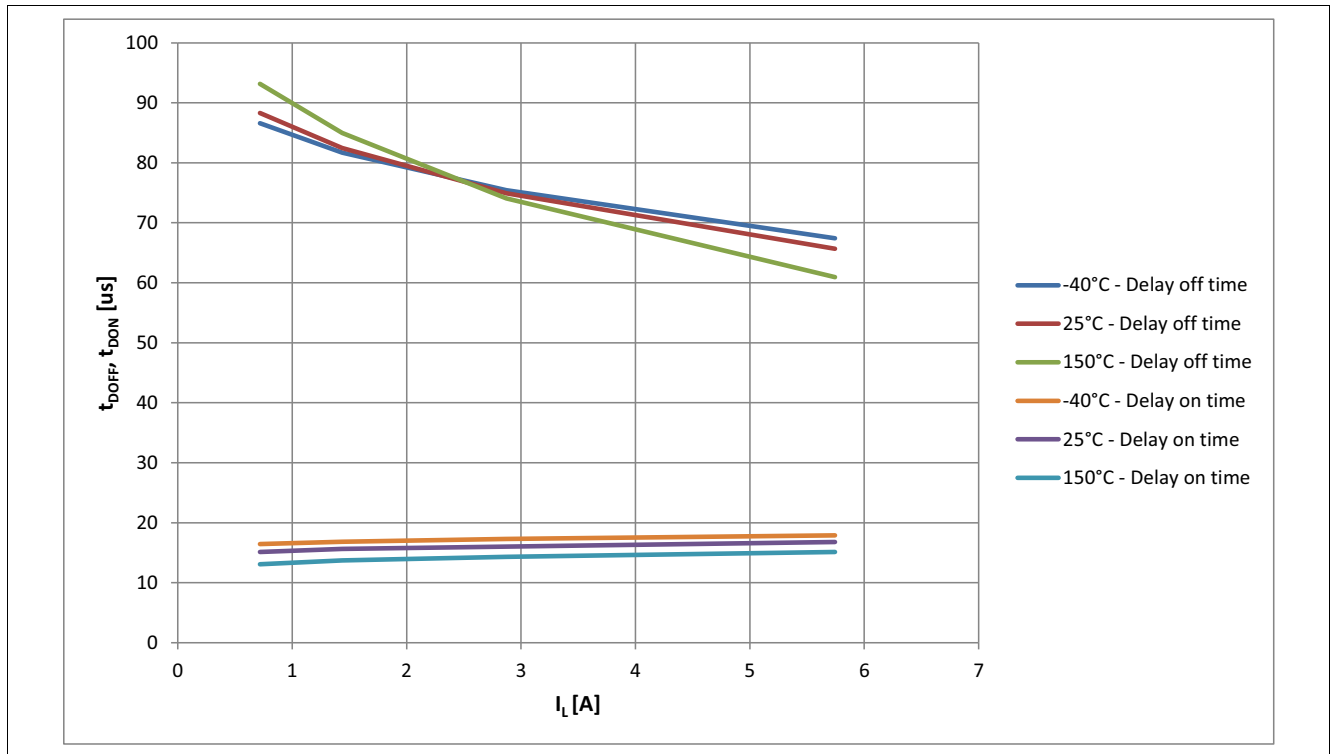

Figure 33 Typical t_{DON} , t_{DOFF} vs I_L @ $V_{\text{IN}} = 5 \text{ V}$, $T_J = -40 \dots 150^\circ\text{C}$

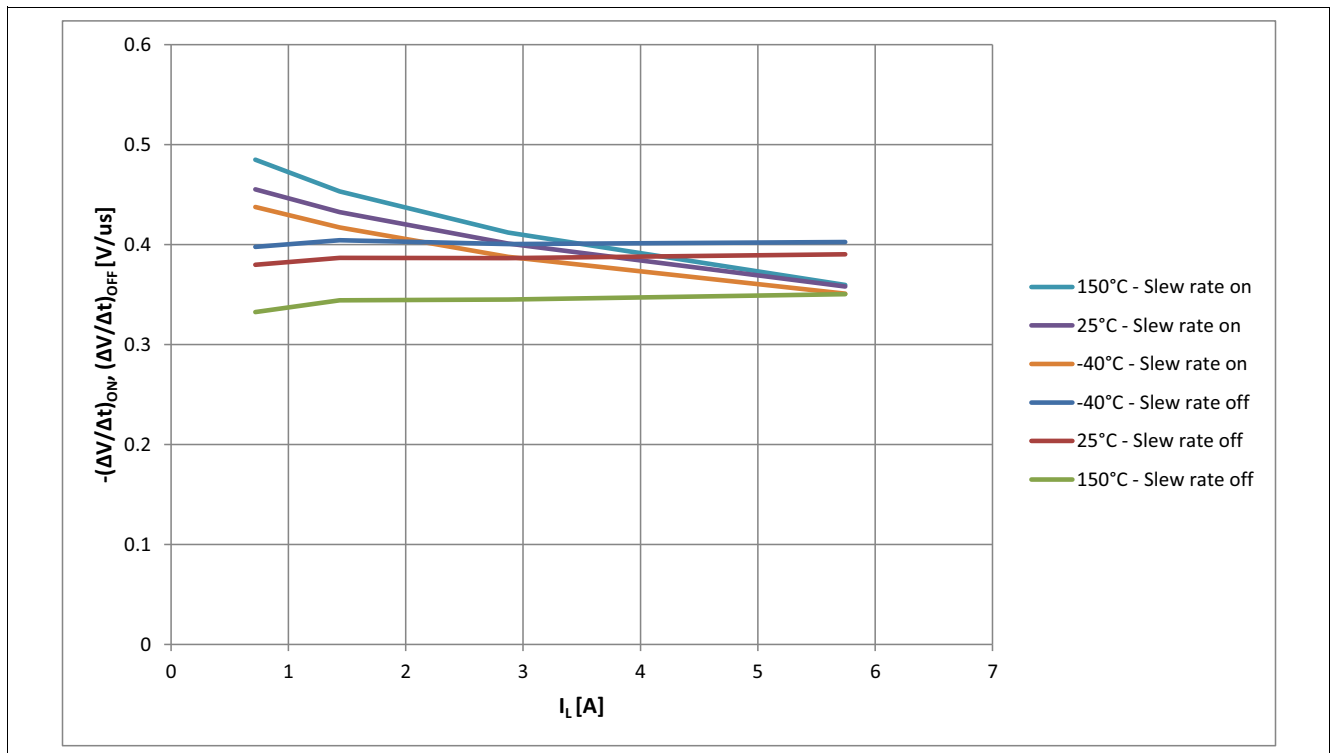

Figure 34 Typical $-(\Delta V/\Delta t)_{\text{ON}}$, $(\Delta V/\Delta t)_{\text{OFF}}$ vs I_L @ $V_{\text{IN}} = 5 \text{ V}$, $T_J = -40 \dots 150^\circ\text{C}$

Characterization Results

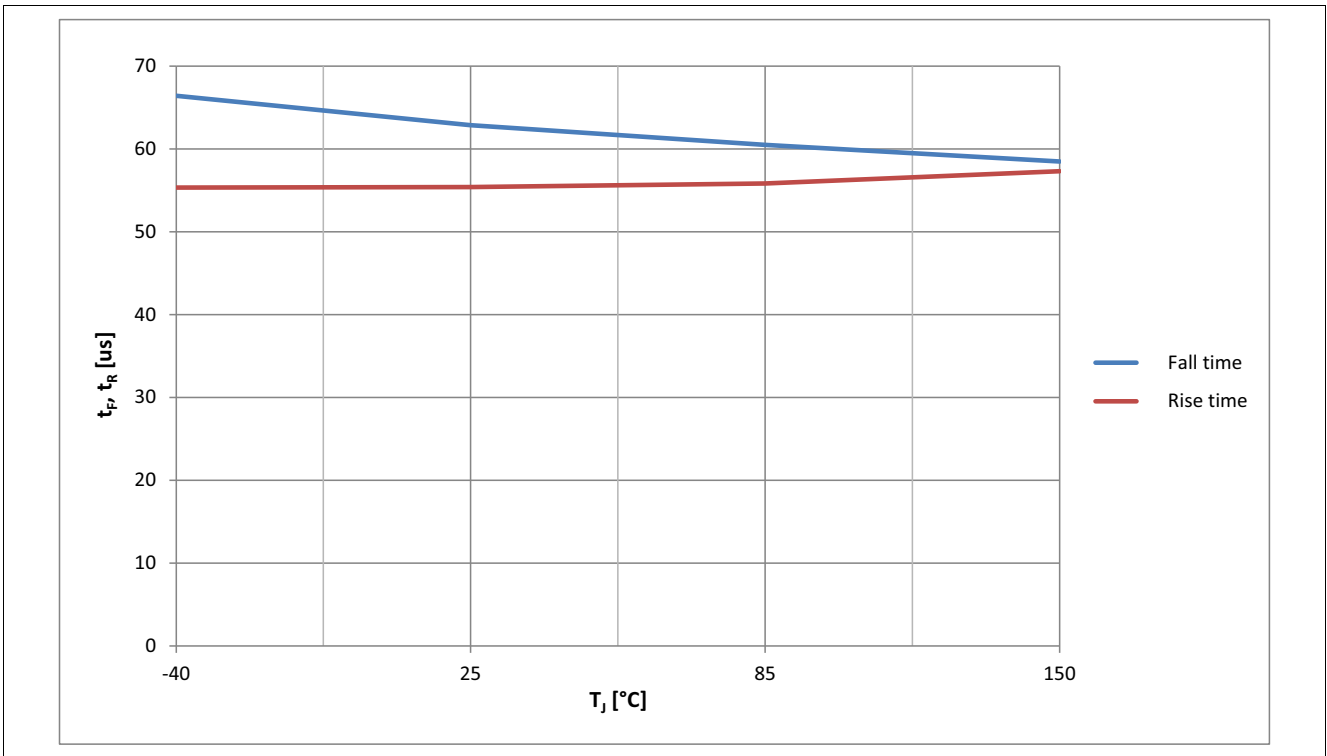

Figure 35 Typical t_F , t_R vs T_J @ $V_{IN} = 5\text{ V}$

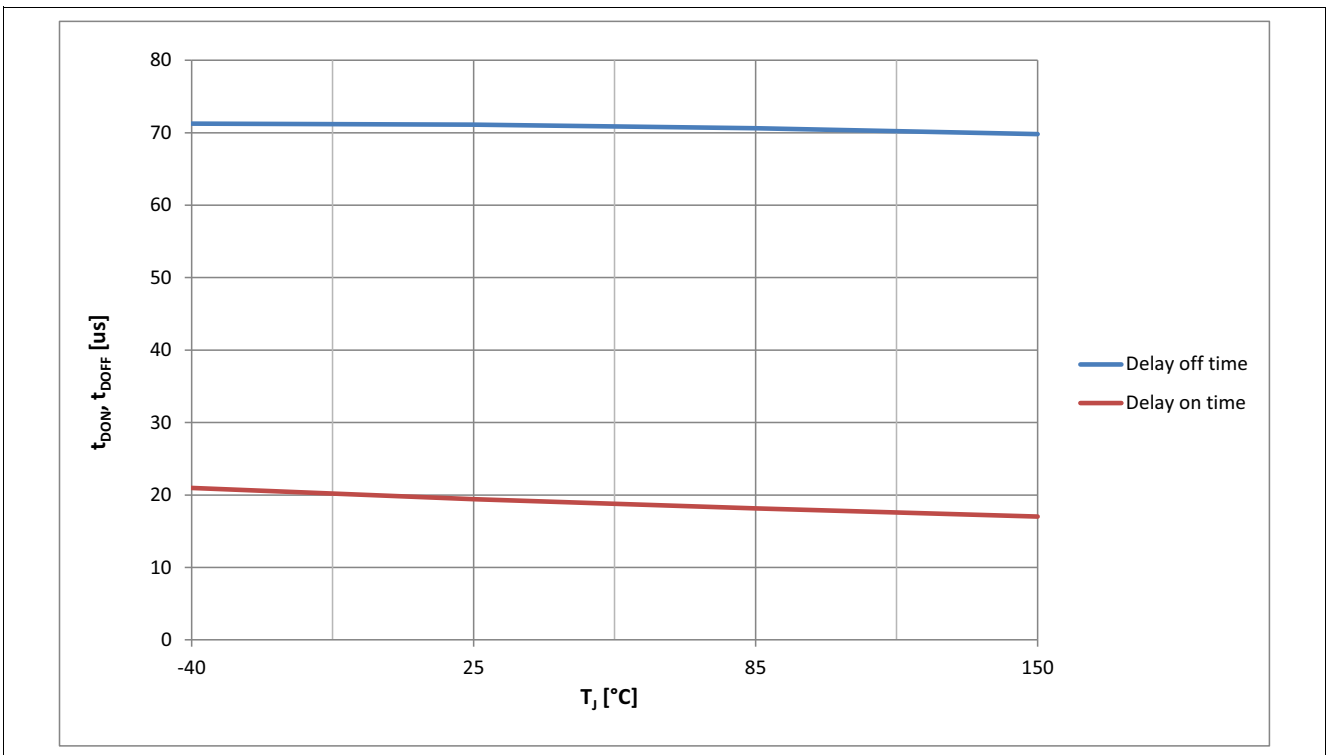

Figure 36 Typical t_{DON} , t_{DOFF} vs T_J @ $V_{IN} = 5\text{ V}$

Characterization Results

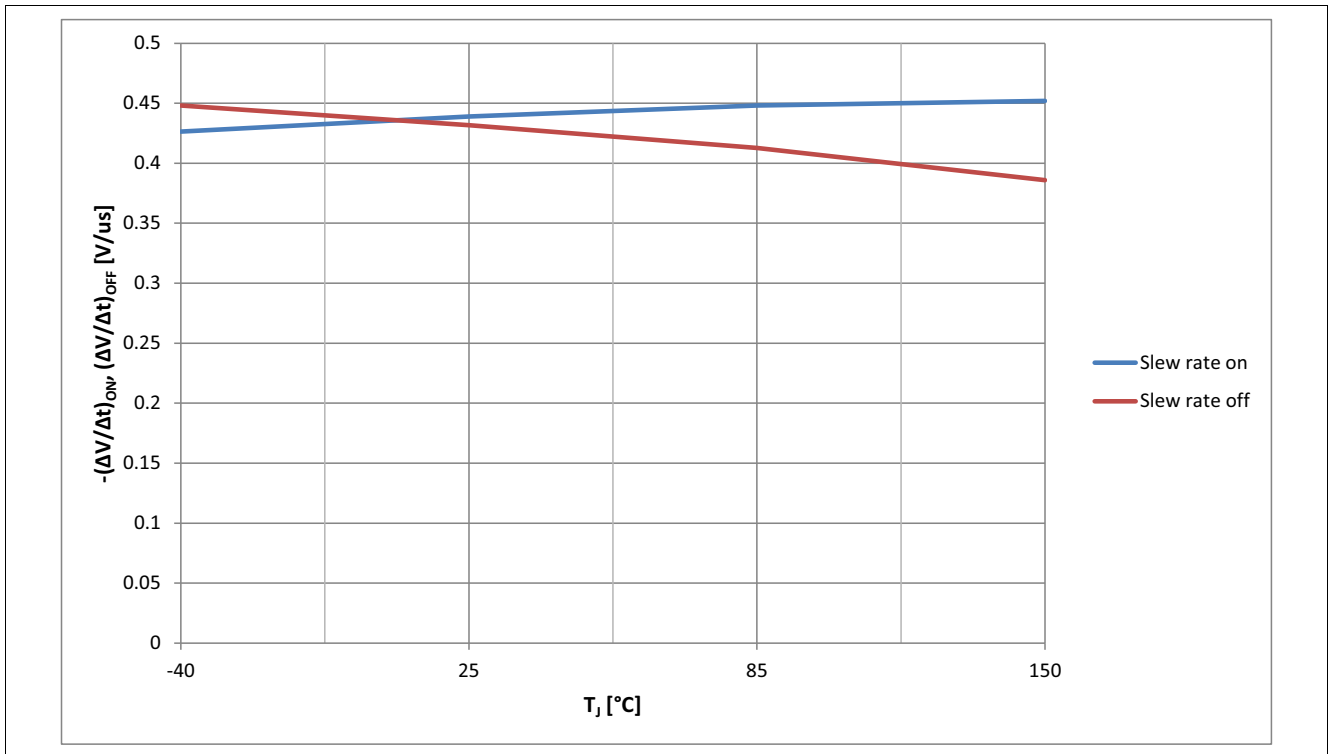

Figure 37 Typical $-(\Delta V/\Delta t)_{ON}$, $(\Delta V/\Delta t)_{OFF}$ vs T_J @ $V_{IN} = 5\text{ V}$

Characterization Results

10.2 Protection

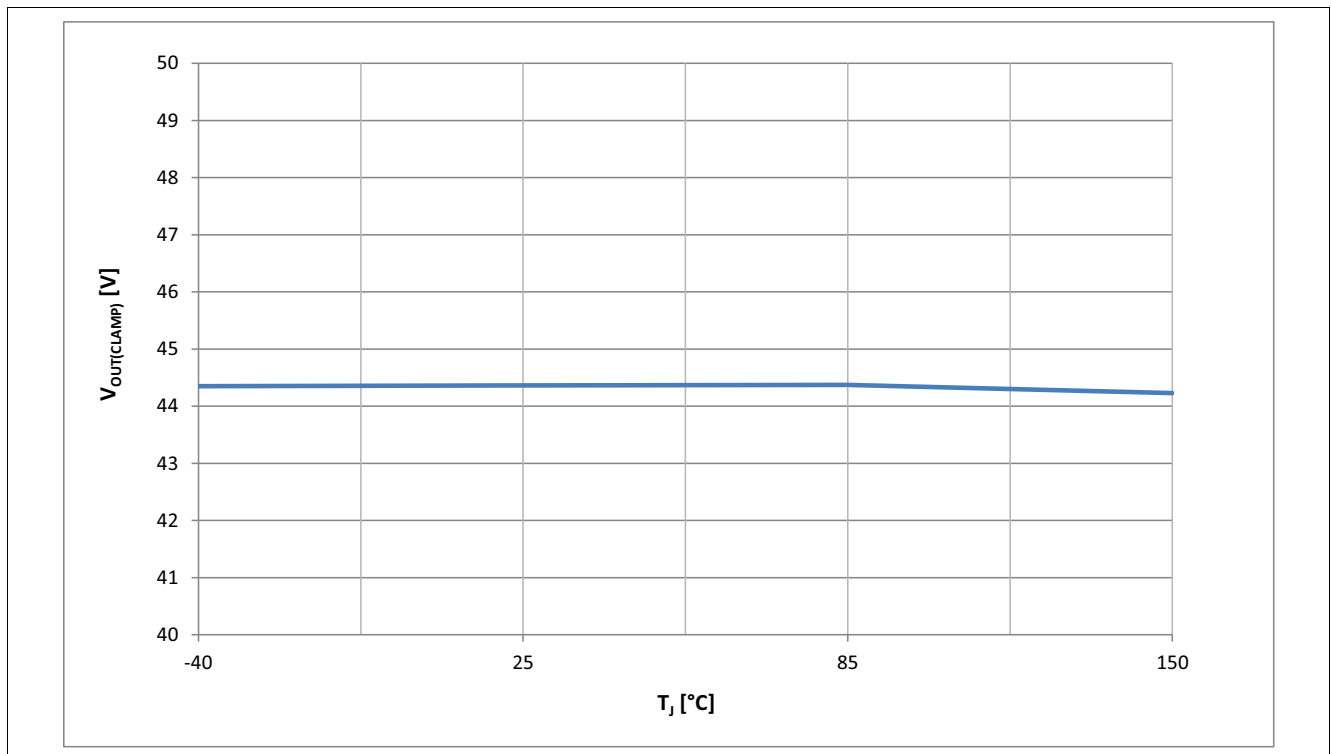

Figure 38 Typical $V_{OUT(CLAMP)}$ vs. T_J @ $I_L = 10$ mA

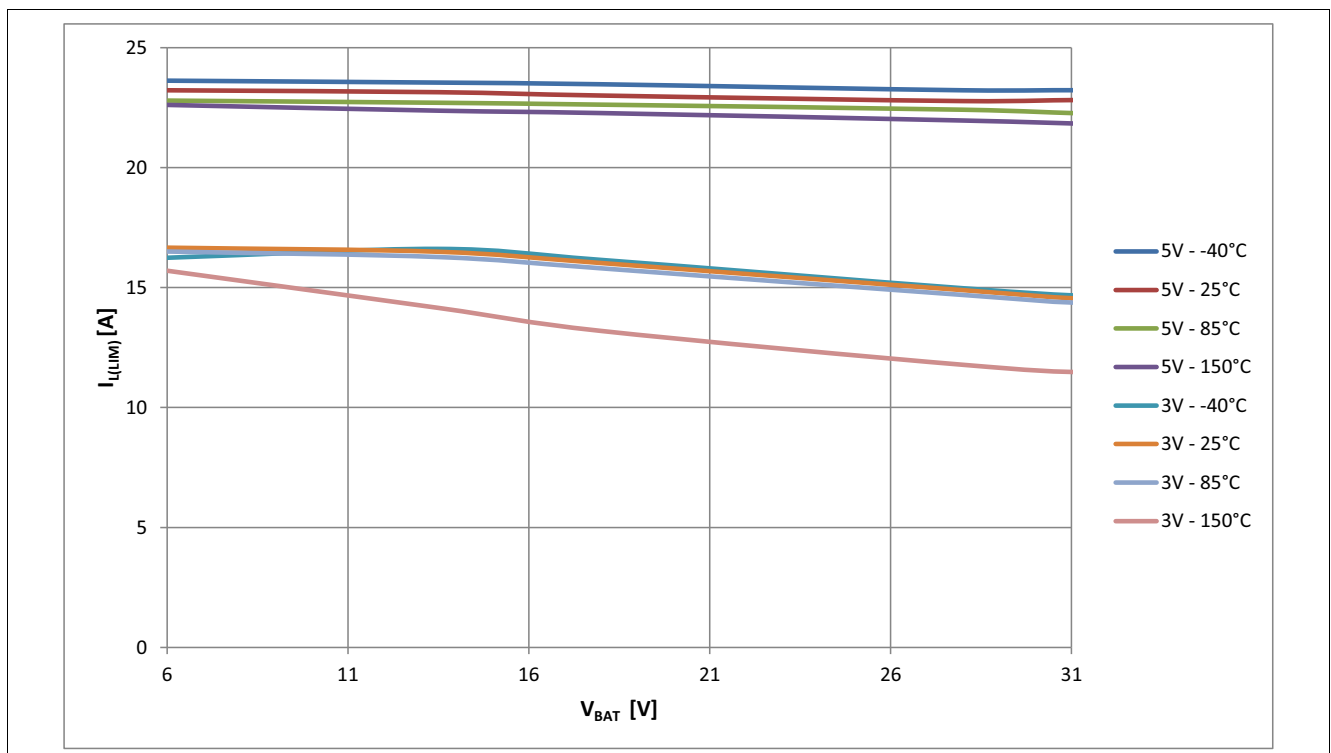

Figure 39 Typical $I_{L(LIM)}$ vs. V_{BAT} @ $T_J = -40 \dots 150^\circ\text{C}$, $V_{IN} = 3$ V and 5 V

Characterization Results

10.3 Input Stage

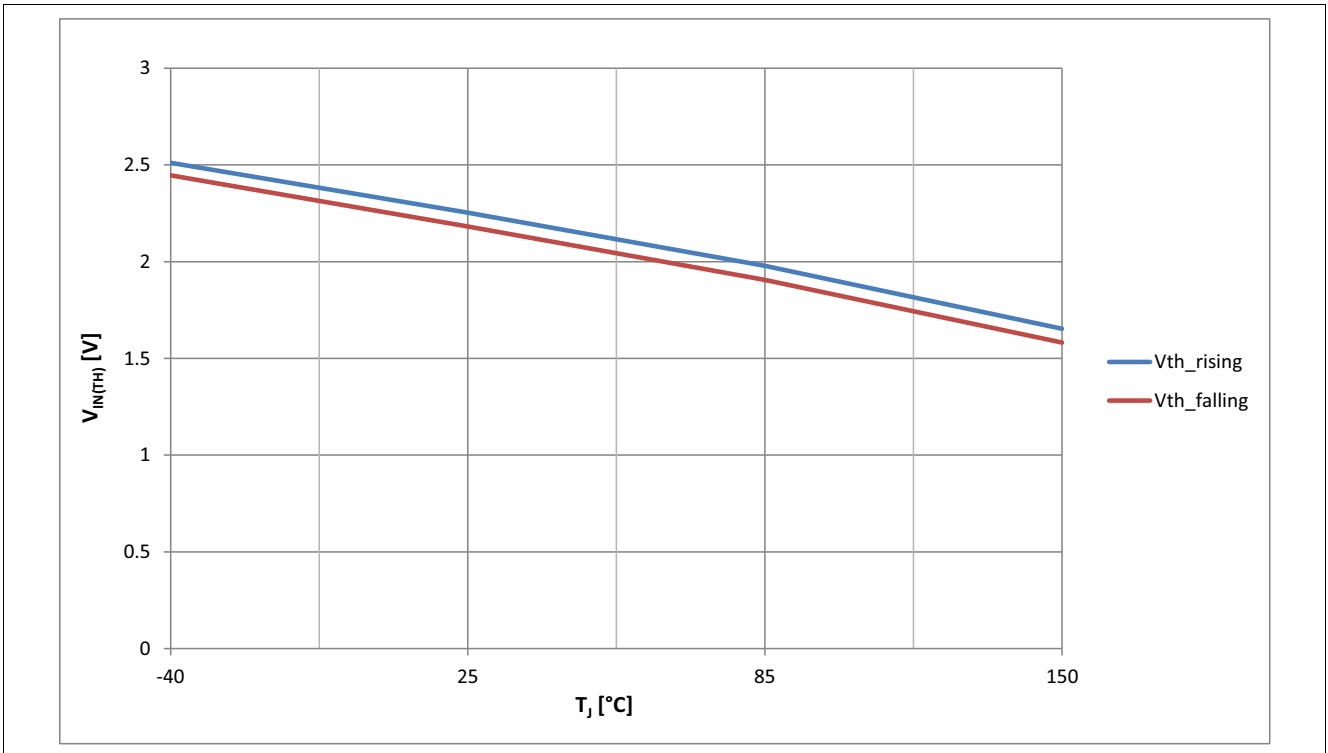

Figure 40 Typical $V_{IN(TH)}$ vs. T_J @ $I_L = 1$ mA

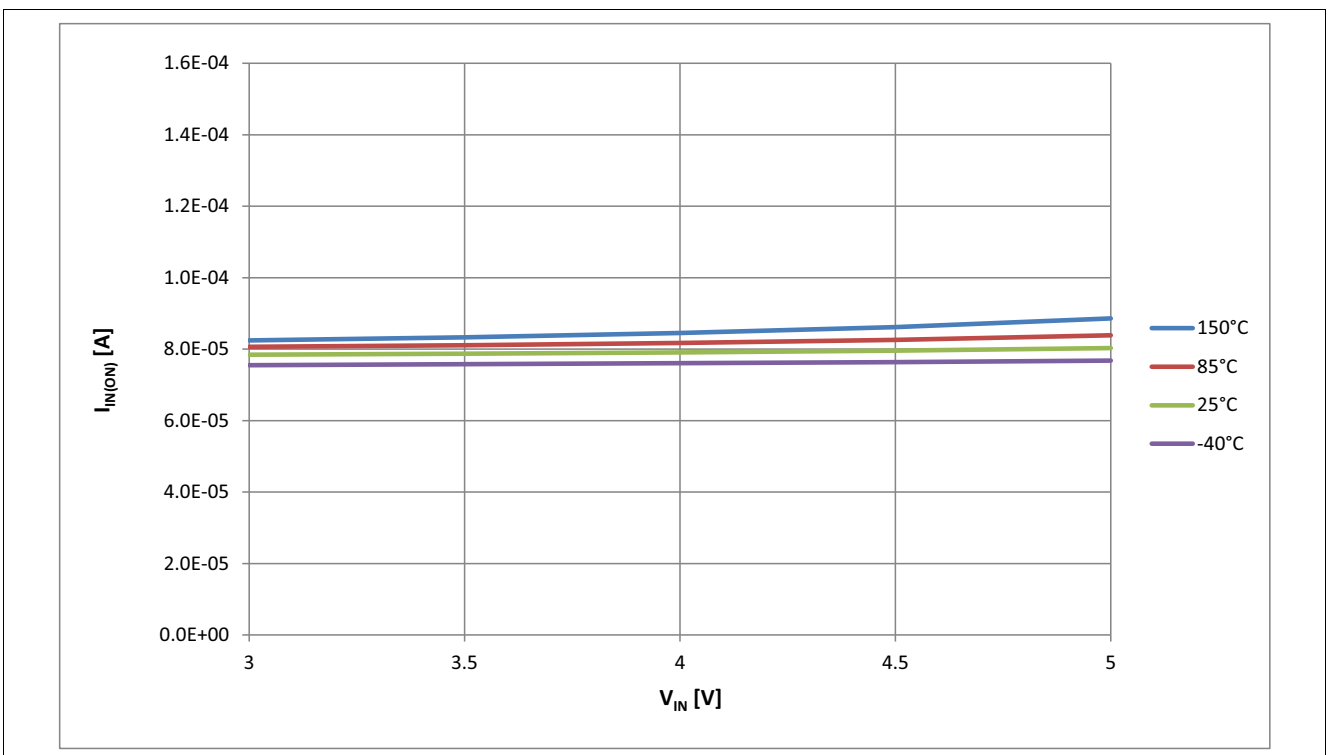

Figure 41 Typical $I_{IN(ON)}$ vs. V_{IN} @ $T_J = -40 \dots 150^\circ\text{C}$, $I_L = I_{L(NOM)}$

Characterization Results

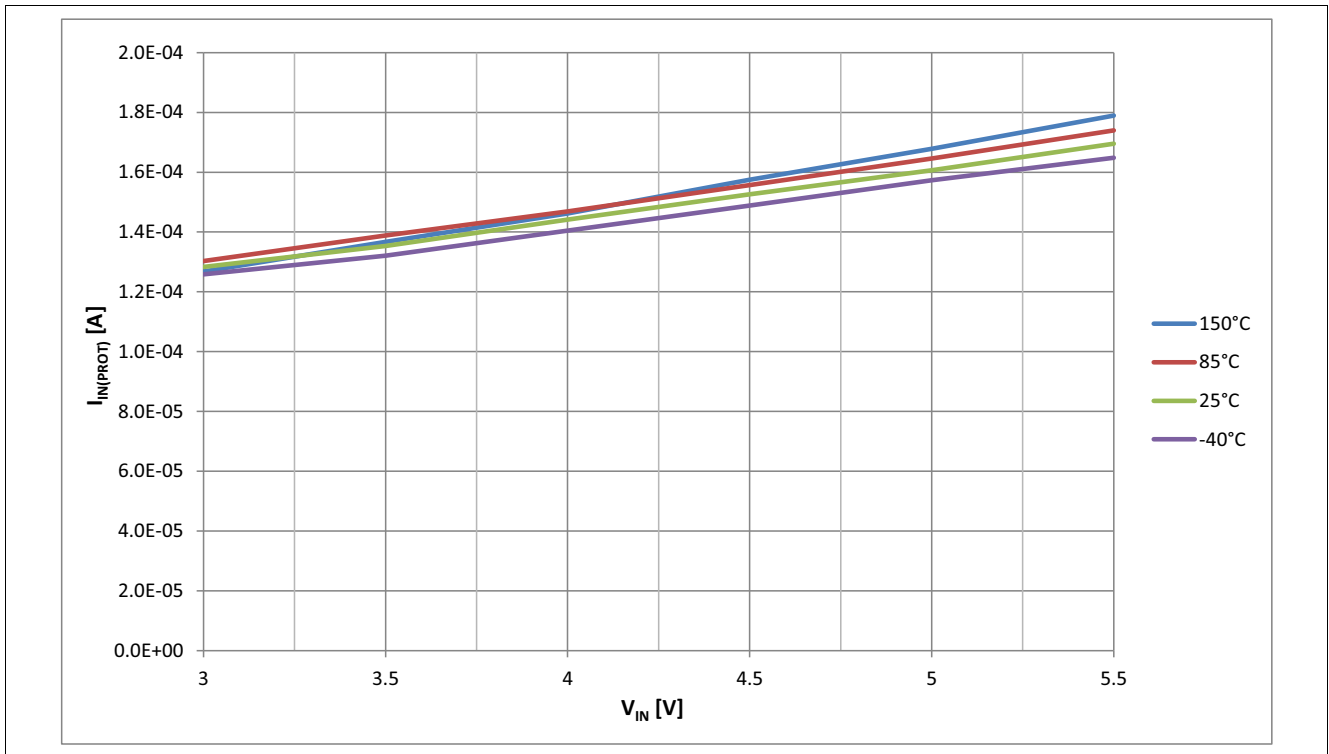

Figure 42 Typical $I_{IN(PROT)}$ vs. V_{IN} @ $T_J = -40 \dots 150^\circ\text{C}$, $I_L = I_{L(NOM)}$

Characterization Results

10.4 Diagnosis

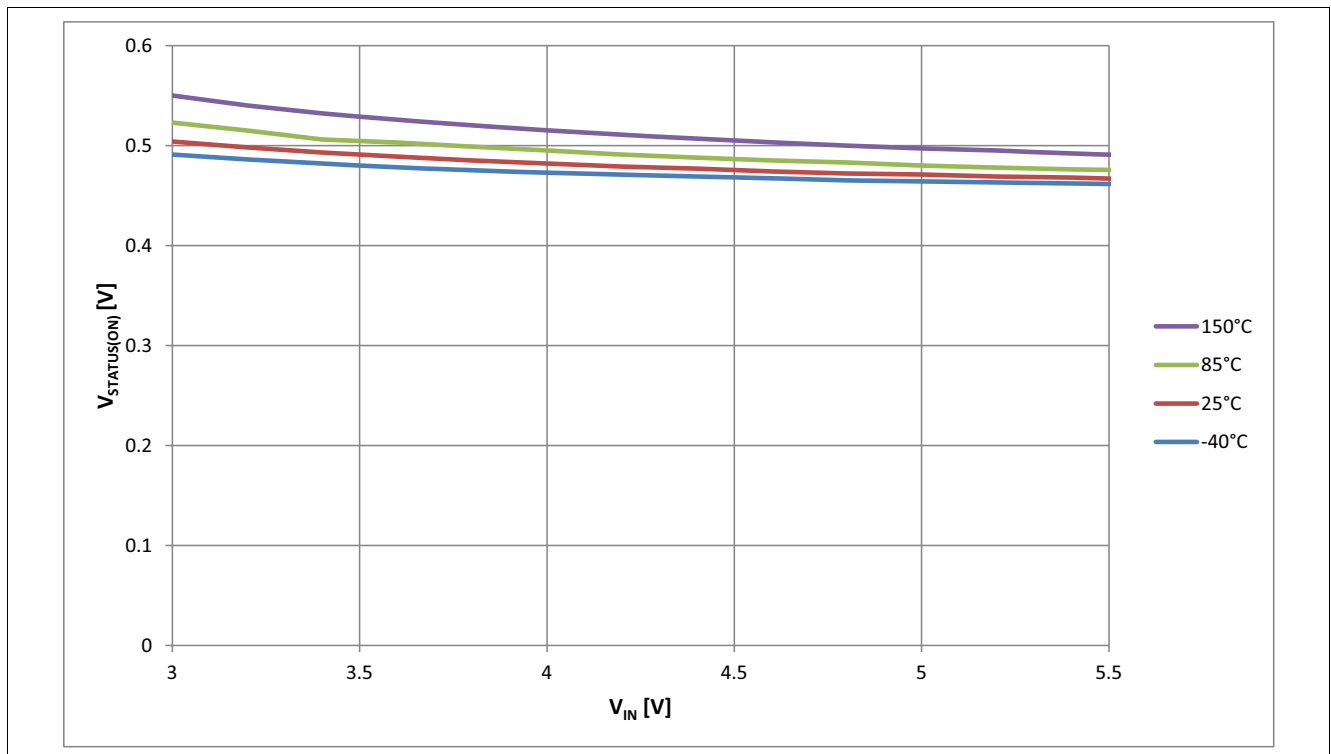

Figure 43 Typical $V_{STATUS(ON)}$ vs. V_{IN} @ $T_J = -40 \dots 150^\circ\text{C}$

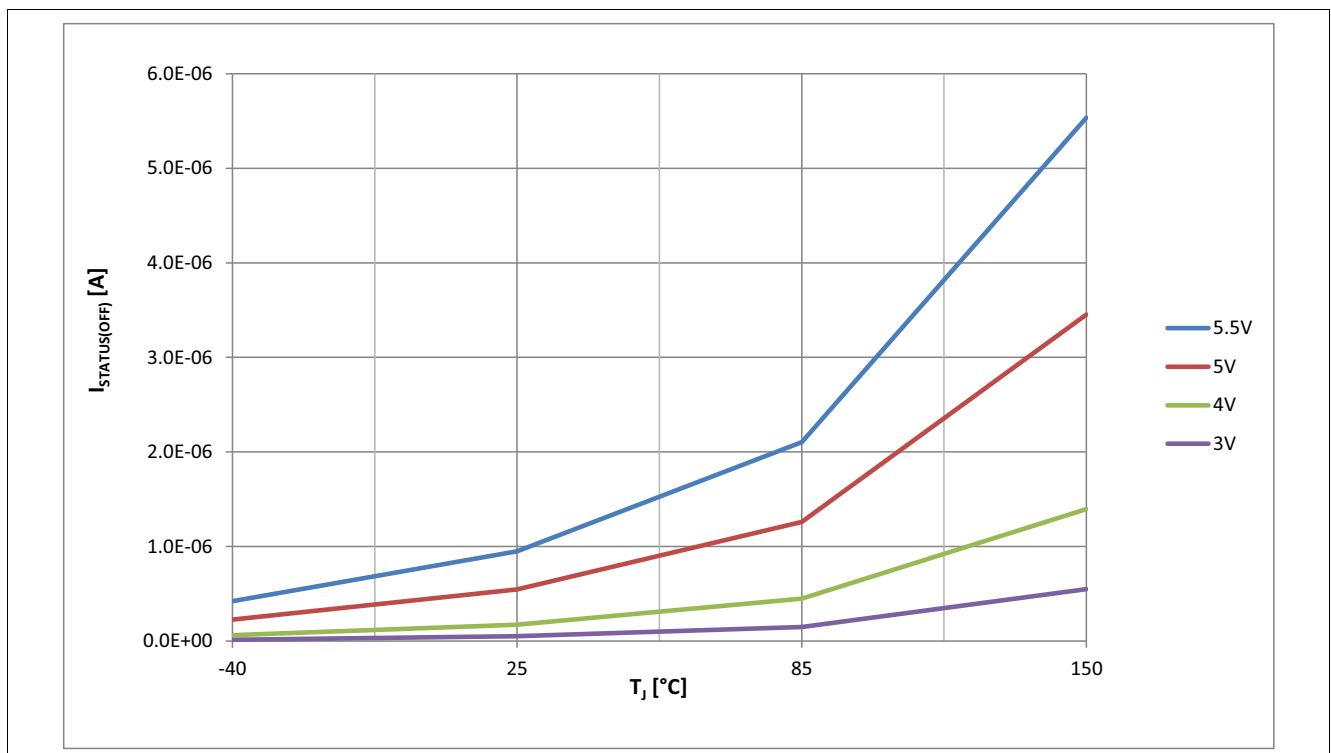

Figure 44 Typical $I_{STATUS(OFF)}$ vs. T_J @ $V_{STATUS} = 3 \dots 5.5\text{ V}$, $V_{IN} = 0\text{ V}$

Characterization Results

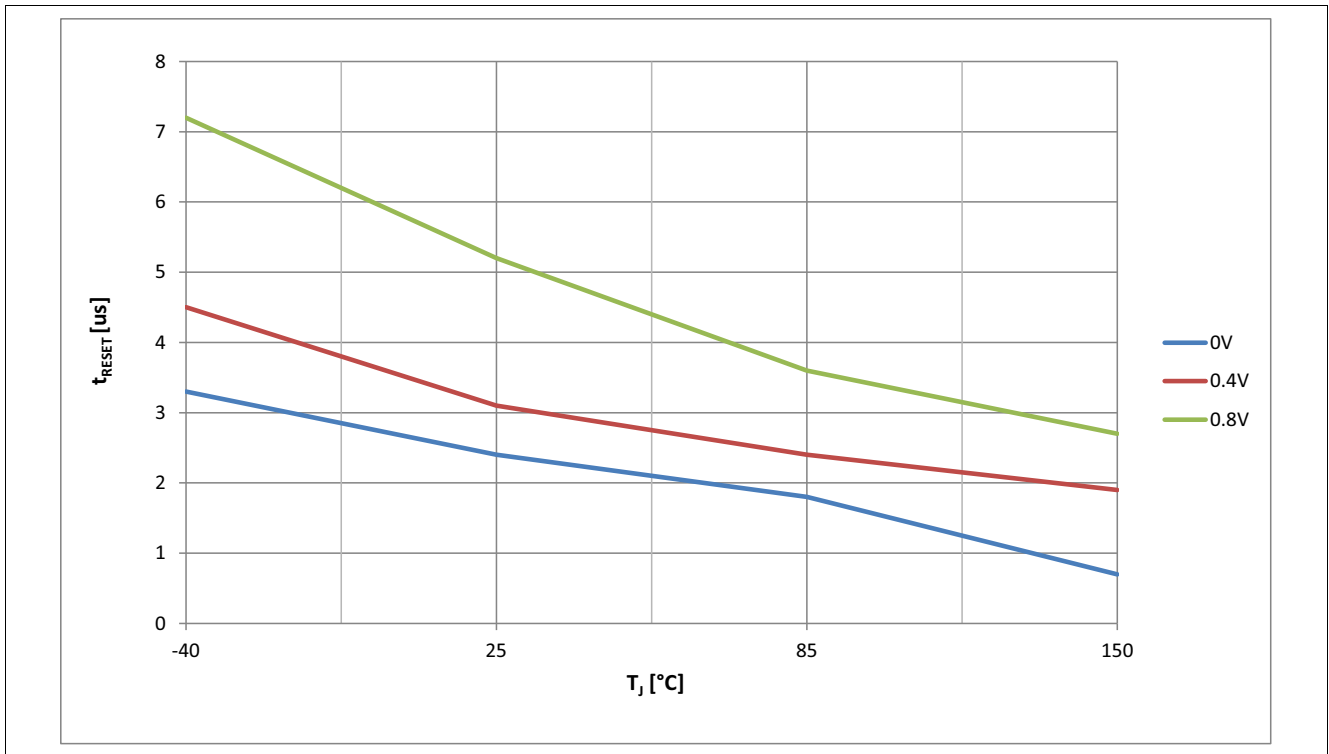

Figure 45 Typical t_{RESET} vs T_J @ $V_{\text{IN}} = 0 \dots 0.8 \text{ V}$

Application Information

11 Application Information

Note: The following information is given as a hint for the implementation of the device only and shall not be regarded as a description or warranty of a certain functionality, condition or quality of the device.

11.1 Application Diagram

An application example with the BTS3050EJ is shown below.

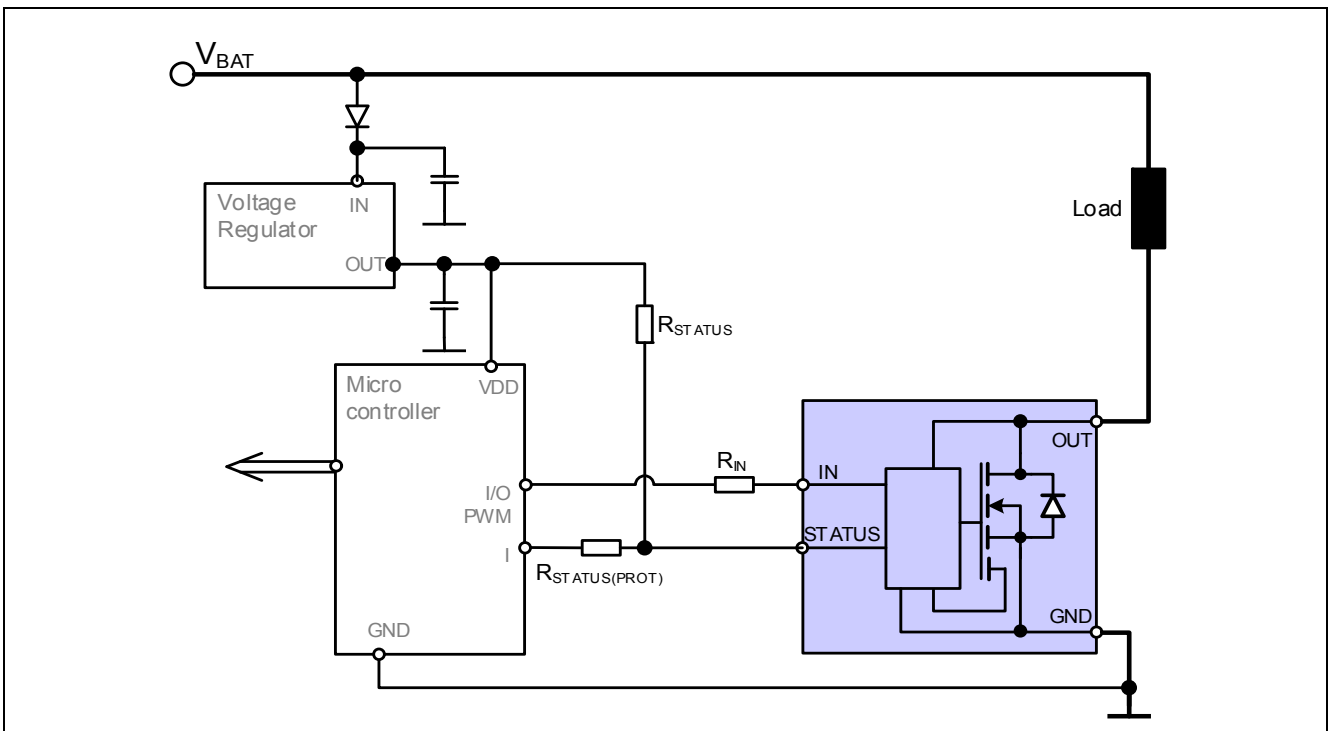

Figure 46 Application example circuitry

Recommended values for $V_{IN}=5\text{ V}$ and $V_{DD}=5\text{ V}$:

$R_{STATUS}=4.7\text{ k}\Omega$

$R_{STATUS(PROT)}=3.3\text{ k}\Omega$

$R_{IN}=3.3\text{ k}\Omega$

Note: This is a very simplified example of an application circuit. The function must be verified in the real application.

12 Package Outlines

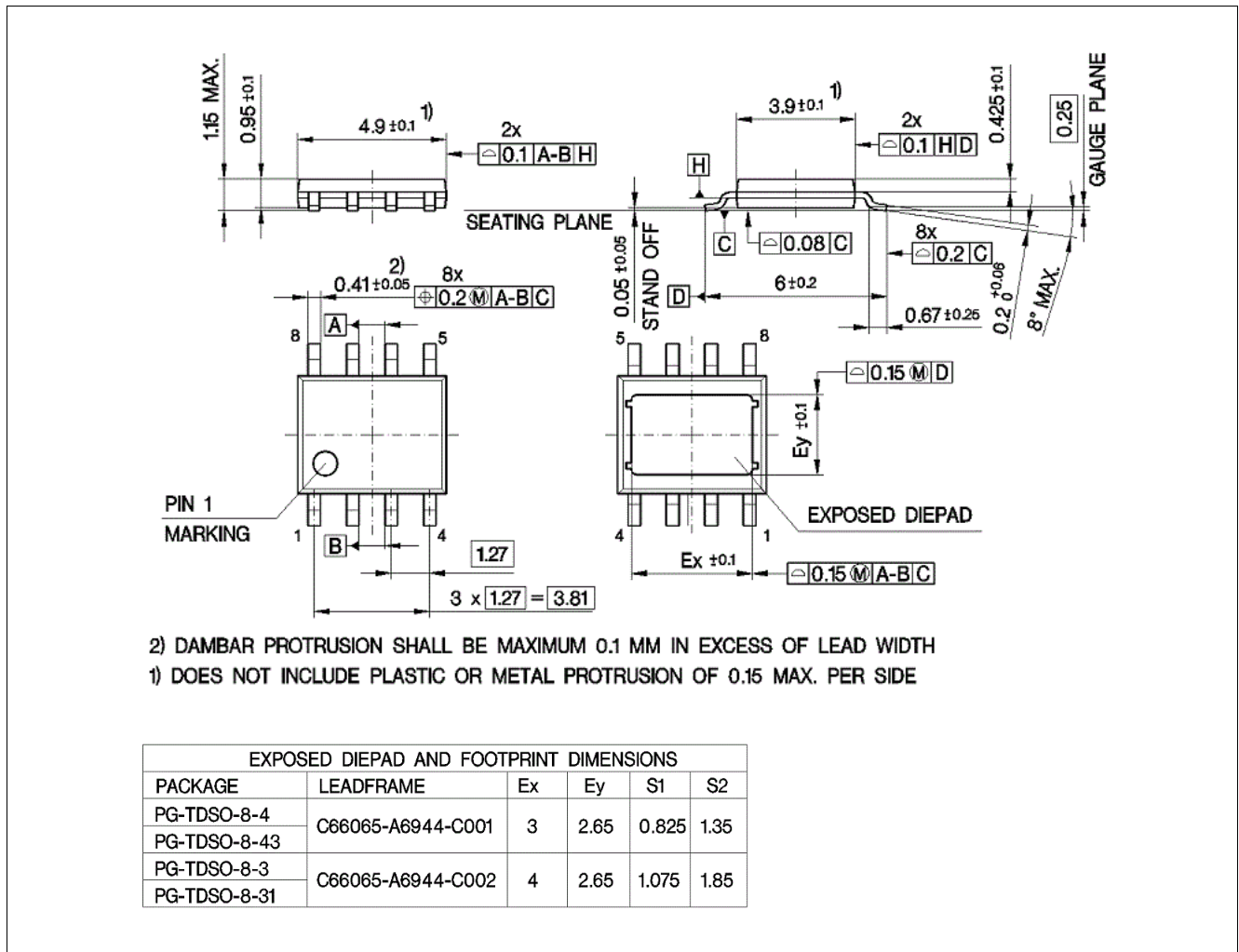

Figure 47 PG-TDSO8-31

Green Product (RoHS compliant)

To meet the world-wide customer requirements for environmentally friendly products and to be compliant with government regulations the device is available as a green product. Green products are RoHS-Compliant (i.e Pb-free finish on leads and suitable for Pb-free soldering according to IPC/JEDEC J-STD-020).

Revision History

13 Revision History

Version	Date	Changes
Rev. 1.0	2016-09-12	Datasheet released

Trademarks of Infineon Technologies AG

μ HVIC™, μ IPM™, μ PFC™, AU-ConvertIR™, AURIX™, C166™, CanPAK™, CIPOS™, CIPURSE™, CoolDP™, CoolGaN™, COOLiR™, CoolMOS™, CoolSET™, CoolSiC™, DAVE™, DI-POL™, DirectFET™, DrBlade™, EasyPIM™, EconoBRIDGE™, EconoDUAL™, EconoPACK™, EconoPIM™, EiceDRIVER™, eupec™, FCOS™, GaNpowIR™, HEXFET™, HITFET™, HybridPACK™, iMOTION™, IRAM™, ISOFACE™, IsoPACK™, LEDriviR™, LITIX™, MIPAQ™, ModSTACK™, my-d™, NovalithIC™, OPTIGA™, OptiMOS™, ORIGA™, PowIRaudio™, PowIRstage™, PrimePACK™, PrimeSTACK™, PROFET™, PRO-SIL™, RASIC™, REAL3™, SmartLEWIS™, SOLID FLASH™, SPOC™, StrongIRFET™, SupIRBuck™, TEMPFET™, TRENCHSTOP™, TriCore™, UHVIC™, XHP™, XMC™.

Trademarks updated November 2015

Other Trademarks

All referenced product or service names and trademarks are the property of their respective owners.

Edition 2016-09-12

Published by

Infineon Technologies AG

81726 Munich, Germany

© 2016 Infineon Technologies AG.

All Rights Reserved.

Do you have a question about any aspect of this document?

Email: erratum@infineon.com

IMPORTANT NOTICE

The information given in this document shall in no event be regarded as a guarantee of conditions or characteristics ("Beschaffheitsgarantie").

With respect to any examples, hints or any typical values stated herein and/or any information regarding the application of the product, Infineon Technologies hereby disclaims any and all warranties and liabilities of any kind, including without limitation warranties of non-infringement of intellectual property rights of any third party.

In addition, any information given in this document is subject to customer's compliance with its obligations stated in this document and any applicable legal requirements, norms and standards concerning customer's products and any use of the product of Infineon Technologies in customer's applications.

The data contained in this document is exclusively intended for technically trained staff. It is the responsibility of customer's technical departments to evaluate the suitability of the product for the intended application and the completeness of the product information given in this document with respect to such application.

For further information on technology, delivery terms and conditions and prices, please contact the nearest Infineon Technologies Office (www.infineon.com).

WARNINGS

Due to technical requirements products may contain dangerous substances. For information on the types in question please contact your nearest Infineon Technologies office.

Except as otherwise explicitly approved by Infineon Technologies in a written document signed by authorized representatives of Infineon Technologies, Infineon Technologies' products may not be used in any applications where a failure of the product or any consequences of the use thereof can reasonably be expected to result in personal injury.