

Emitter Controlled Diode Rapid 1 Advanced Isolation

Rapid Switching Emitter Controlled Diode in fully isolated package

Features:

- 650V Emitter Controlled technology
- Temperature stable behaviour of key parameters
- Low forward voltage (V_F)
- Low reverse recovery charge (Q_{rr})
- Low reverse recovery current (I_{rrm})
- Maximum junction temperature 175°C
- 2500 VRMS electrical isolation, 50/60 Hz, $t = 1$ min
- 100 % tested isolated mounting surface
- Pb-free lead plating
- RoHS compliant

Potential Applications:

- Air Conditioning
- GPD (General Purpose Drives)
- Industrial SMPS

Package pin definition:

- Pin 1 - anode (A1)
- Pin 2 - cathode (C)
- Pin 3 - anode (A2)

Product Validation:

Qualified for industrial applications according to the relevant tests of JEDEC 47/20/22

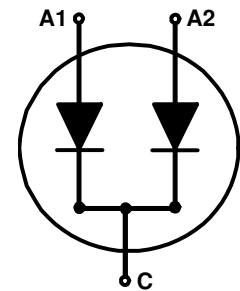

Fully isolated package TO-247



Key Performance and Package Parameters

Type	V_{rrm}	I_f	$V_f, T_{vj}=25^\circ\text{C}$	T_{vjmax}	Marking	Package
IDFW60C65D1	650V	2x 30A	1.45V	175°C	C60ED1	PG-TO247-3-AI

Emitter Controlled Diode Rapid 1 Advanced Isolation**Table of Contents**

Description	1
Table of Contents	2
Maximum Ratings (per leg)	3
Thermal Resistances (per leg)	3
Electrical Characteristics	3
Electrical Characteristics Diagrams	6
Package Drawing	9
Testing Conditions	10
Revision History	11
Disclaimer	12

Emitter Controlled Diode Rapid 1 Advanced Isolation

Maximum Ratings (per leg)

For optimum lifetime and reliability, Infineon recommends operating conditions that do not exceed 80% of the maximum ratings stated in this datasheet.

Parameter	Symbol	Value	Unit
Repetitive peak reverse voltage, $T_{vj} \geq 25^{\circ}\text{C}$	V_{RRM}	650	V
Diode forward current, limited by T_{vjmax} $T_h = 25^{\circ}\text{C}$ $T_h = 65^{\circ}\text{C}$	I_F	56.0 43.0	A
Diode pulsed current, t_p limited by T_{vjmax}	I_{Fpuls}	90.0	A
Diode surge non repetitive forward current $T_h = 25^{\circ}\text{C}$, $t_p = 10.0\text{ms}$, sine halfwave	I_{FSM}	240.0	A
Power dissipation $T_h = 25^{\circ}\text{C}$ Power dissipation $T_h = 65^{\circ}\text{C}$	P_{tot}	100.0 73.0	W
Operating junction temperature	T_{vj}	-40...+175	$^{\circ}\text{C}$
Storage temperature	T_{stg}	-55...+150	$^{\circ}\text{C}$
Soldering temperature, wave soldering 1.6mm (0.063in.) from case for 10s		260	$^{\circ}\text{C}$
Mounting torque, M3 screw Maximum of mounting processes: 3	M	0.6	Nm
Isolation voltage RMS, $f = 50/60\text{Hz}$, $t = 1\text{min}^{1)}$	V_{isol}	2500	V

Thermal Resistances (per leg)

Parameter	Symbol	Conditions	Value			Unit
			min.	typ.	max.	
R_{th} Characteristics						
Diode thermal resistance, ²⁾ junction - heatsink	$R_{th(j-h)}$		-	1.37	1.50	K/W
Thermal resistance junction - ambient	$R_{th(j-a)}$		-	-	65	K/W

Electrical Characteristics (per leg), at $T_{vj} = 25^{\circ}\text{C}$, unless otherwise specified

Parameter	Symbol	Conditions	Value			Unit
			min.	typ.	max.	
Static Characteristic						
Diode forward voltage	V_F	$I_F = 30.0\text{A}$ $T_{vj} = 25^{\circ}\text{C}$ $T_{vj} = 125^{\circ}\text{C}$ $T_{vj} = 175^{\circ}\text{C}$	- - -	1.45 1.42 1.40	1.75 - -	V
Reverse leakage current ³⁾	I_R	$V_R = 650\text{V}$ $T_{vj} = 25^{\circ}\text{C}$ $T_{vj} = 175^{\circ}\text{C}$	- -	- 1200	40 -	μA

¹⁾ For a proper handling and assembly of the advanced isolation device in the application refer to the note at the package drawing.

²⁾ At force on body $F = 500\text{N}$, $T_a = 25^{\circ}\text{C}$

³⁾ Reverse leakage current per leg specified for operating conditions with zero voltage applied to the other leg.

Emitter Controlled Diode Rapid 1 Advanced Isolation

Electrical Characteristic, at $T_{vj} = 25^{\circ}\text{C}$, unless otherwise specified

Parameter	Symbol	Conditions	Value			Unit
			min.	typ.	max.	
Dynamic Characteristic						
Internal emitter inductance measured 5mm (0.197 in.) from case	L_E		-	13.0	-	nH

Switching Characteristics (per leg), Inductive Load

Parameter	Symbol	Conditions	Value			Unit
			min.	typ.	max.	
Diode Characteristic, at $T_{vj} = 25^{\circ}\text{C}$						
Diode reverse recovery time	t_{rr}	$T_{vj} = 25^{\circ}\text{C}$, $V_R = 400\text{V}$, $I_F = 30.0\text{A}$, $di_F/dt = 1000\text{A}/\mu\text{s}$, $L\sigma = 30\text{nH}$, $C\sigma = 40\text{pF}$, switch IGW50N65H5.	-	65	-	ns
Diode reverse recovery charge	Q_{rr}		-	0.76	-	μC
Diode peak reverse recovery current	I_{rrm}		-	17.6	-	A
Diode peak rate of fall of reverse recovery current during t_b	di_{rr}/dt		-	-1360	-	$\text{A}/\mu\text{s}$
Diode reverse recovery time	t_{rr}	$T_{vj} = 25^{\circ}\text{C}$, $V_R = 400\text{V}$, $I_F = 30.0\text{A}$, $di_F/dt = 200\text{A}/\mu\text{s}$, $L\sigma = 30\text{nH}$, $C\sigma = 40\text{pF}$, switch IGW50N65H5.	-	112	-	ns
Diode reverse recovery charge	Q_{rr}		-	0.47	-	μC
Diode peak reverse recovery current	I_{rrm}		-	4.5	-	A
Diode peak rate of fall of reverse recovery current during t_b	di_{rr}/dt		-	-655	-	$\text{A}/\mu\text{s}$

Switching Characteristics (per leg), Inductive Load

Parameter	Symbol	Conditions	Value			Unit
			min.	typ.	max.	
Diode Characteristic, at $T_{vj} = 175^{\circ}\text{C}/125^{\circ}\text{C}$						
Diode reverse recovery time	t_{rr}	$T_{vj} = 175^{\circ}\text{C}$, $V_R = 400\text{V}$, $I_F = 30.0\text{A}$, $di_F/dt = 1000\text{A}/\mu\text{s}$, $L\sigma = 30\text{nH}$, $C\sigma = 40\text{pF}$, switch IGW50N65H5.	-	102	-	ns
Diode reverse recovery charge	Q_{rr}		-	1.80	-	μC
Diode peak reverse recovery current	I_{rrm}		-	25.9	-	A
Diode peak rate of fall of reverse recovery current during t_b	di_{rr}/dt		-	-995	-	$\text{A}/\mu\text{s}$
Diode reverse recovery time	t_{rr}	$T_{vj} = 125^{\circ}\text{C}$, $V_R = 400\text{V}$, $I_F = 30.0\text{A}$, $di_F/dt = 200\text{A}/\mu\text{s}$, $L\sigma = 30\text{nH}$, $C\sigma = 40\text{pF}$, switch IGW50N65H5.	-	148	-	ns
Diode reverse recovery charge	Q_{rr}		-	0.98	-	μC
Diode peak reverse recovery current	I_{rrm}		-	8.5	-	A
Diode peak rate of fall of reverse recovery current during t_b	di_{rr}/dt		-	-485	-	$\text{A}/\mu\text{s}$

Emitter Controlled Diode Rapid 1 Advanced Isolation

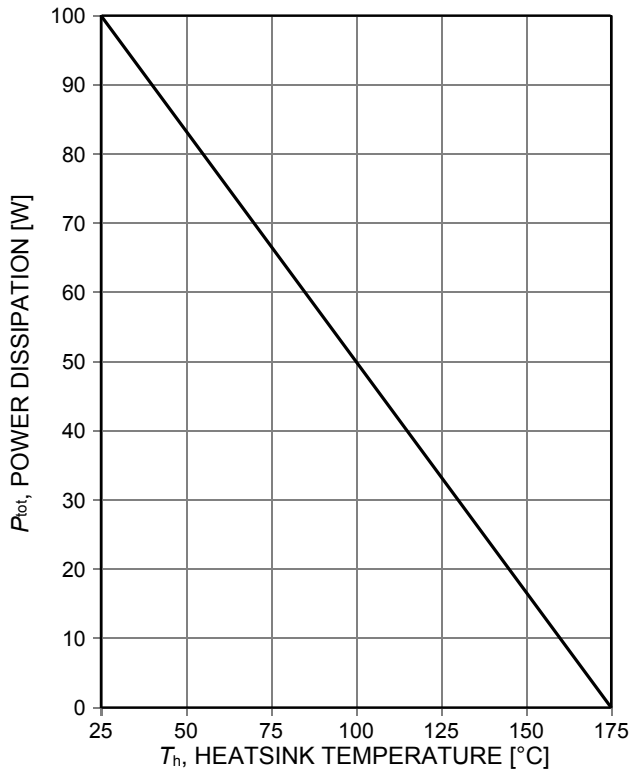

Figure 1. Power dissipation per leg as a function of heatsink temperature ($T_{vj} \leq 175^\circ\text{C}$)

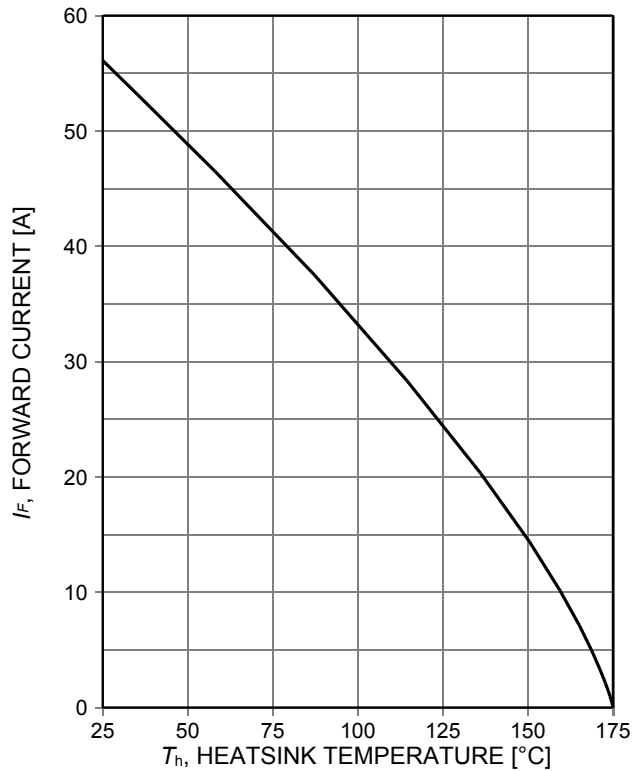

Figure 2. Diode forward current per leg as a function of heatsink temperature ($T_{vj} \leq 175^\circ\text{C}$)

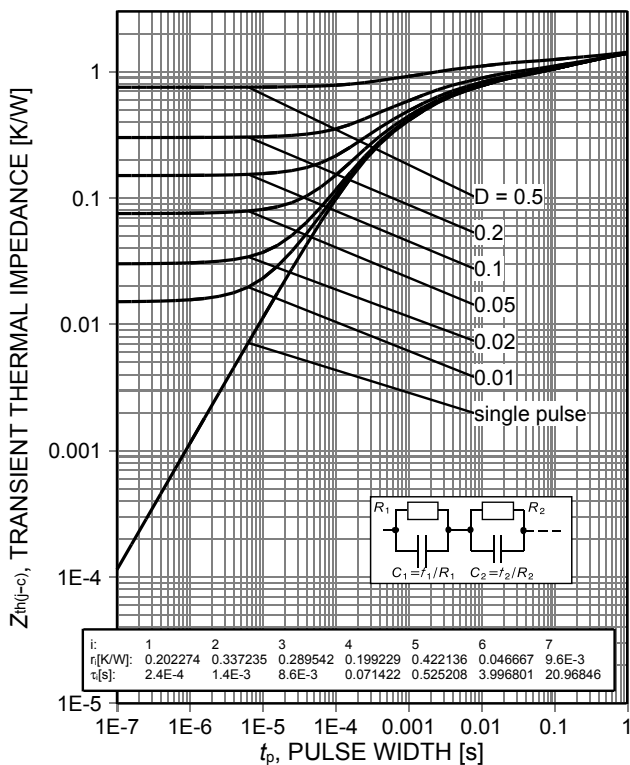

Figure 3. Diode transient thermal impedance per leg as a function of pulse width ($D = t_p/T$)

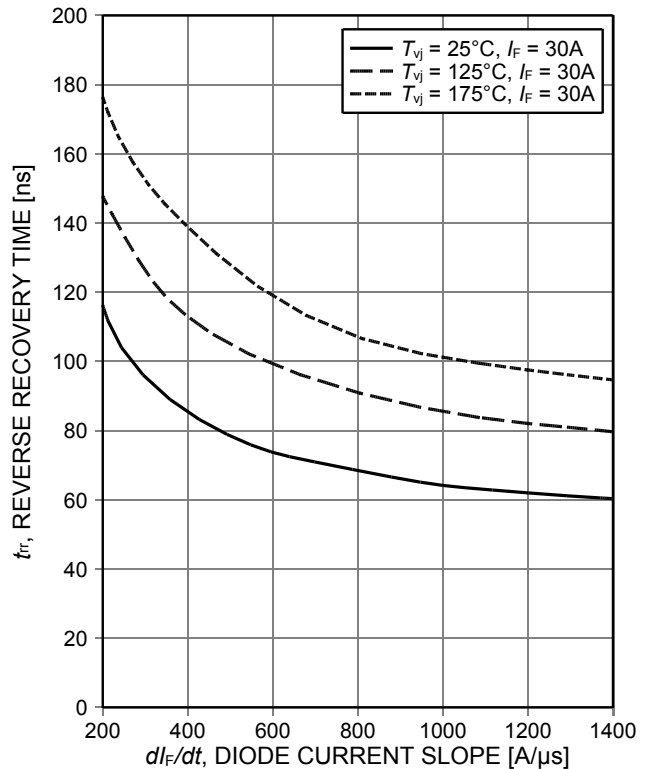

Figure 4. Typical reverse recovery time per leg as a function of diode current slope ($V_R = 400\text{V}$)

Emitter Controlled Diode Rapid 1 Advanced Isolation

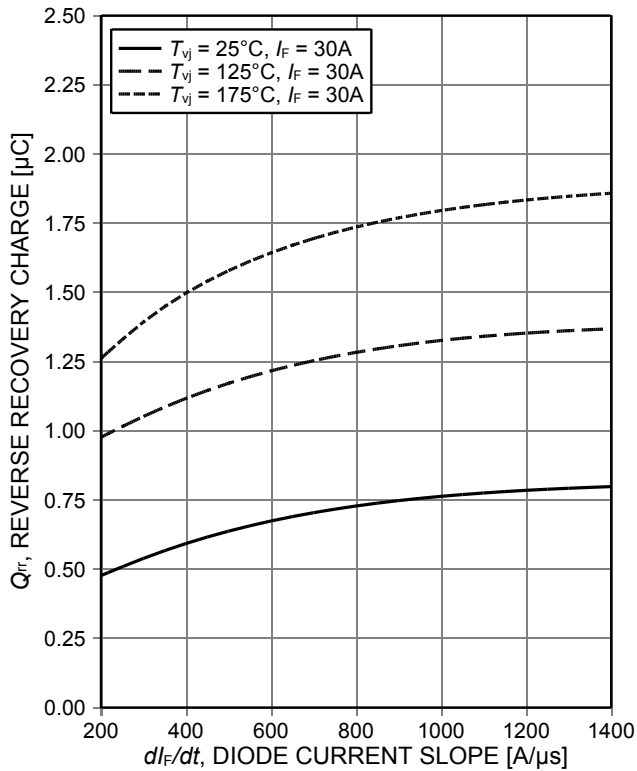

Figure 5. Typical reverse recovery charge per leg as a function of diode current slope ($V_R=400V$)

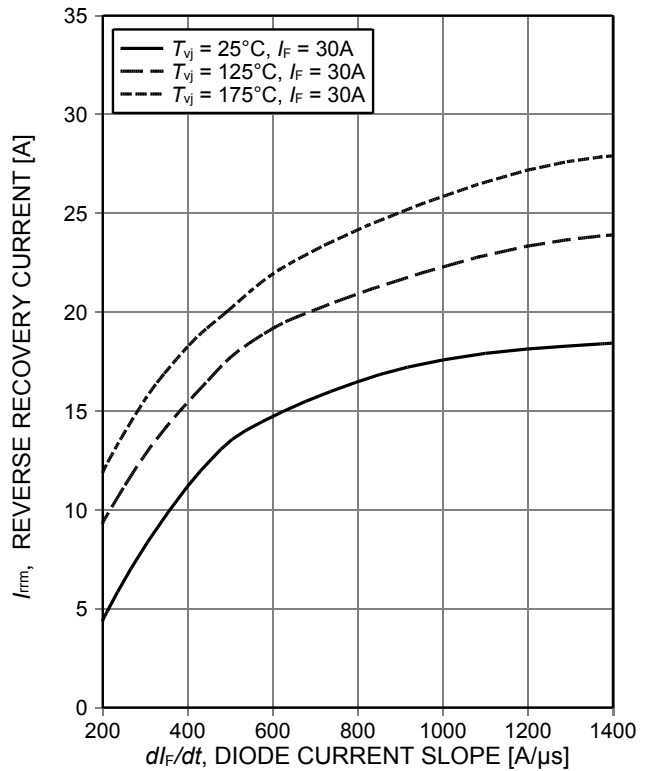

Figure 6. Typical peak reverse recovery current per leg as a function of diode current slope ($V_R=400V$)

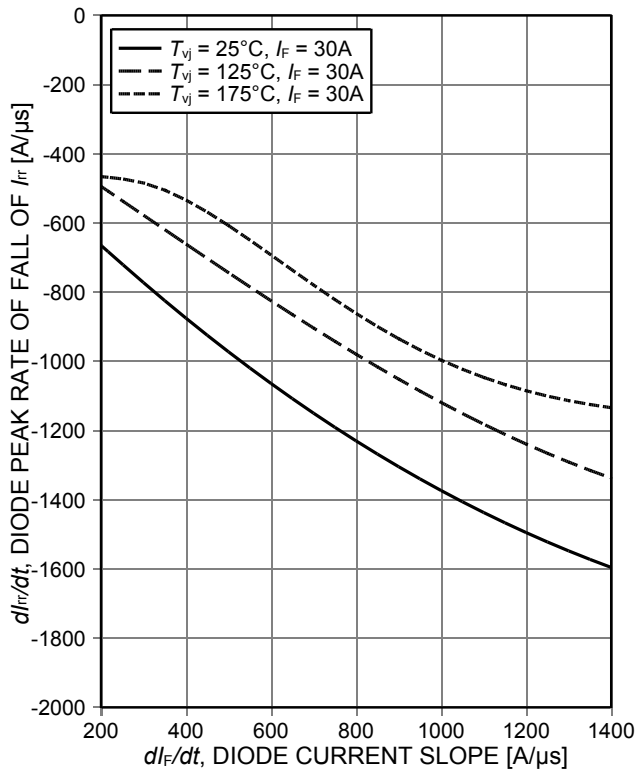

Figure 7. Typical diode peak rate of fall of rev. rec. current per leg as a function of diode current slope ($V_R=400V$)

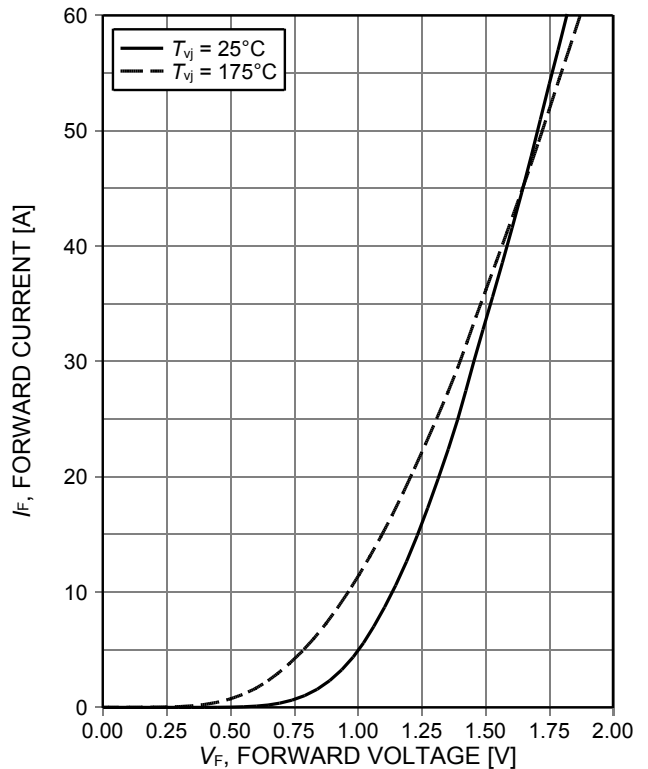

Figure 8. Typical diode forward current per leg as a function of forward voltage

Emitter Controlled Diode Rapid 1 Advanced Isolation

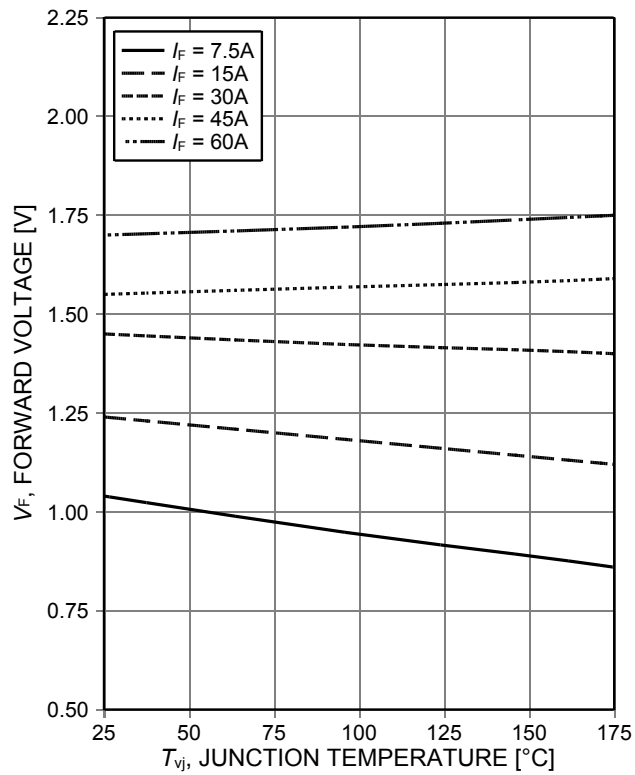
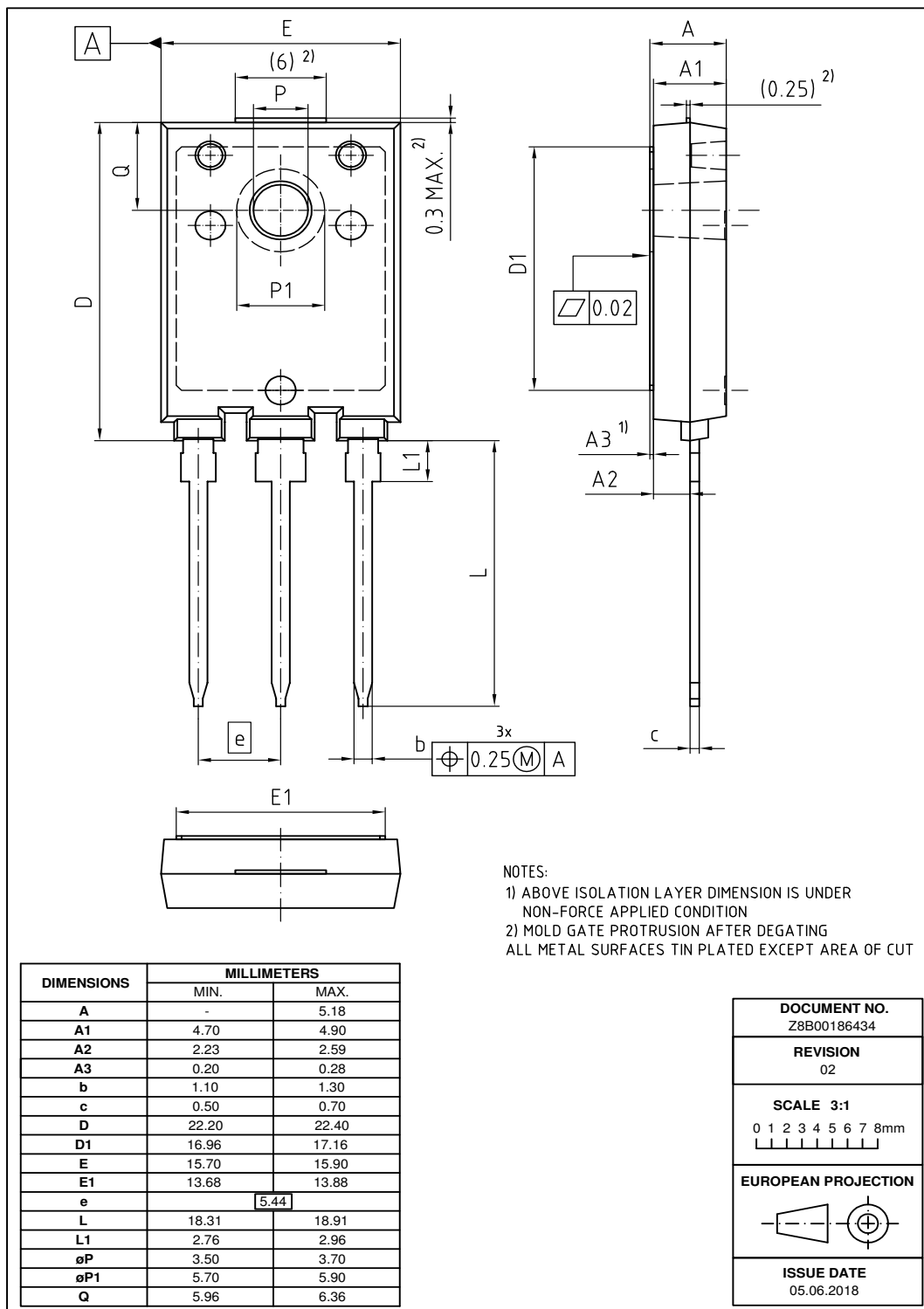

Figure 9. Typical diode forward voltage per leg as a function of junction temperature

PG-TO247-3-AI (PG-HSIP247-3)



Note: For a proper handling and assembly of the advanced isolation device in the application the isolation layer must not be exposed to potential penetration via sharp implements or mechanical impacts/shocks, which exceed levels indicated in International Standard (IEC60068-2-6 and IEC60068-2-27). The advanced isolation device is intended only to be used assembled on an appropriate heatsink with recommended flatness of <20µm per 100mm and roughness of <10µm.

Emitter Controlled Diode Rapid 1 Advanced Isolation

Testing Conditions

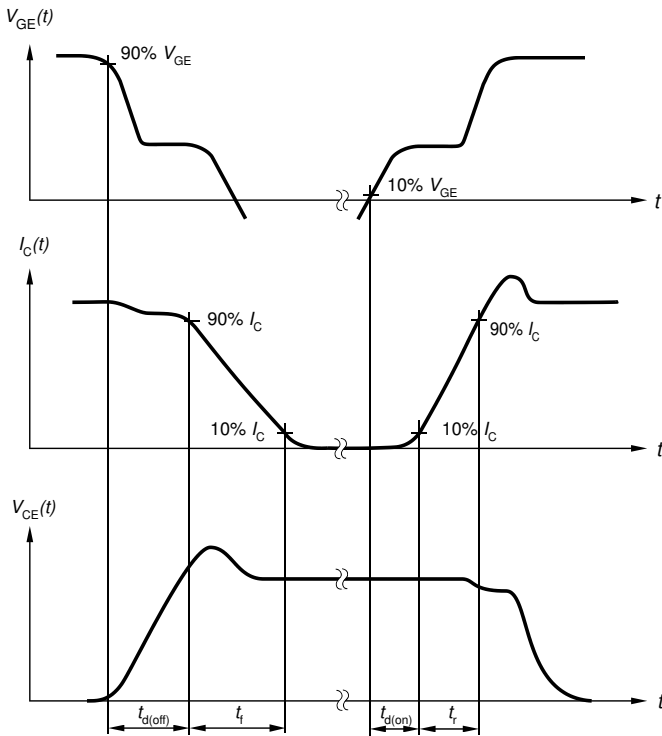

Figure A. Definition of switching times

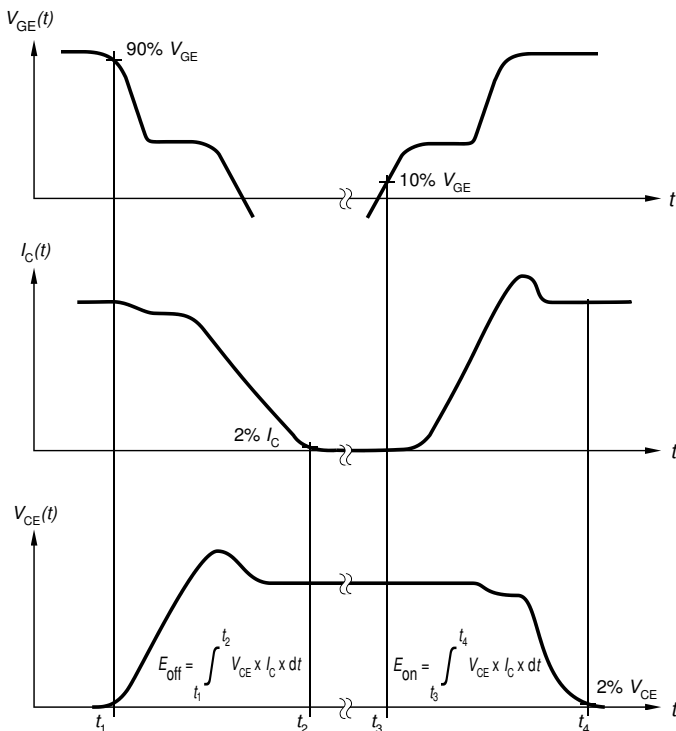

Figure B. Definition of switching losses

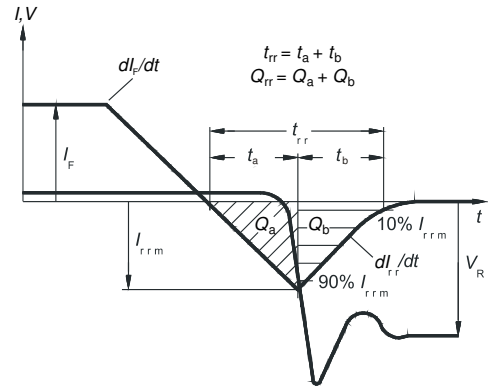

Figure C. Definition of diode switching characteristics

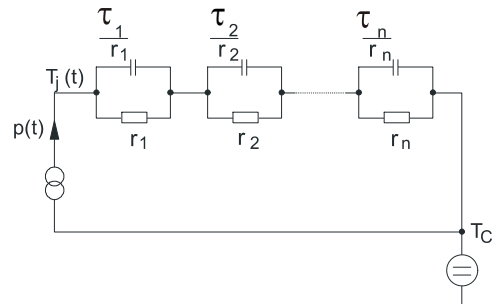

Figure D. Thermal equivalent circuit

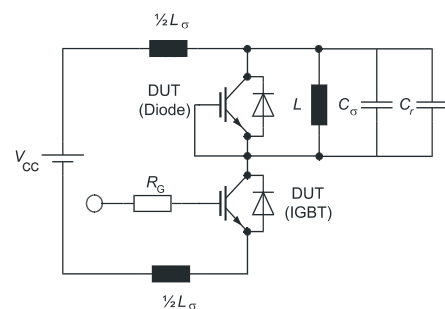

Figure E. Dynamic test circuit
Parasitic inductance L_{σ} ,
parasitic capacitor C_{σ} ,
relief capacitor C_r ,
(only for ZVT switching)

Emitter Controlled Diode Rapid 1 Advanced Isolation

Revision History

IDFW60C65D1

Revision: 2019-05-20, Rev. 2.2

Previous Revision

Revision	Date	Subjects (major changes since last revision)
2.1	2018-06-20	Final data sheet
2.2	2019-05-20	New marking description

Trademarks

All referenced product or service names and trademarks are the property of their respective owners.

**Published by
Infineon Technologies AG
81726 München, Germany
© Infineon Technologies AG 2019.
All Rights Reserved.**

Important Notice

The information given in this document shall in no event be regarded as a guarantee of conditions or characteristics ("Beschaffenheitsgarantie"). With respect to any examples, hints or any typical values stated herein and/or any information regarding the application of the product, Infineon Technologies hereby disclaims any and all warranties and liabilities of any kind, including without limitation warranties of non-infringement of intellectual property rights of any third party.

In addition, any information given in this document is subject to customer's compliance with its obligations stated in this document and any applicable legal requirements, norms and standards concerning customer's products and any use of the product of Infineon Technologies in customer's applications.

The data contained in this document is exclusively intended for technically trained staff. It is the responsibility of customer's technical departments to evaluate the suitability of the product for the intended application and the completeness of the product information given in this document with respect to such application.

For further information on the product, technology, delivery terms and conditions and prices please contact your nearest Infineon Technologies office (www.infineon.com).

Please note that this product is not qualified according to the AEC Q100 or AEC Q101 documents of the Automotive Electronics Council.

Warnings

Due to technical requirements products may contain dangerous substances. For information on the types in question please contact your nearest Infineon Technologies office.

Except as otherwise explicitly approved by Infineon Technologies in a written document signed by authorized representatives of Infineon Technologies, Infineon Technologies' products may not be used in any applications where a failure of the product or any consequences of the use thereof can reasonably be expected to result in personal injury.