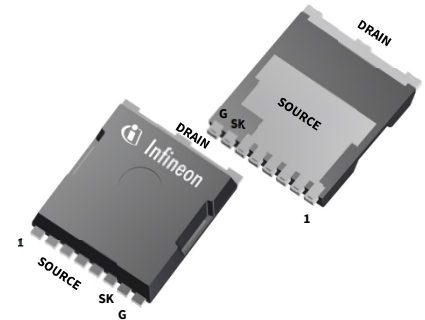


# IGT60R070D1

## 600V CoolGaN™ enhancement-mode Power Transistor

### Features

- Enhancement mode transistor – Normally OFF switch
- Ultra fast switching
- No reverse-recovery charge
- Capable of reverse conduction
- Low gate charge, low output charge
- Superior commutation ruggedness
- Qualified for industrial applications according to JEDEC Standards (JESD47 and JESD22)



### Benefits

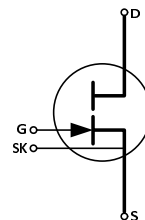
- Improves system efficiency
- Improves power density
- Enables higher operating frequency
- System cost reduction savings
- Reduces EMI

Gate	8
Drain	drain contact
Kelvin Source	7
Source	1,2,3,4,5,6

### Applications

Industrial, telecom, datacenter SMPS based on the half-bridge topology (half-bridge topologies for hard and soft switching such as Totem pole PFC, high frequency LLC).

**For other applications:** review CoolGaN™ reliability white paper and contact Infineon regional support



**Table 1 Key Performance Parameters at T<sub>j</sub> = 25 °C**

Parameter	Value	Unit
V <sub>DS,max</sub>	600	V
R <sub>DS(on),max</sub>	70	mΩ
Q <sub>G,typ</sub>	5.8	nC
I <sub>D,pulse</sub>	60	A
Q <sub>oss @ 400 V</sub>	41	nC
Q <sub>rr</sub>	0	nC



**Table 2 Ordering Information**

Type / Ordering Code	Package	Marking	Related links
IGT60R070D1	PG-HSOF-8-3	60R070D1	see Appendix A



**Table of Contents**

**Features ..... 1**

**Benefits .....1**

**Applications..... 1**

**Table of Contents ..... 2**

**1       Maximum ratings..... 3**

**2       Thermal characteristics..... 4**

**3       Electrical characteristics ..... 5**

**4       Electrical characteristics diagrams ..... 7**

**5       Test Circuits .....13**

**6       Package Outlines .....14**

**7       Appendix .....15**

**8       Revision History .....16**

# 1 Maximum ratings

at  $T_j = 25\text{ °C}$ , unless otherwise specified. Continuous application of maximum ratings can deteriorate transistor lifetime. For further information, contact your local Infineon sales office.

**Table 3 Maximum ratings**

Parameter	Symbol	Values			Unit	Note/Test Condition
		Min.	Typ.	Max.		
Drain Source Voltage, continuous <sup>1</sup>	$V_{DS,max}$	-	-	600	V	$V_{GS} = 0\text{ V}$
Drain source destructive breakdown voltage <sup>2</sup>	$V_{DS,bd}$	800	-	-	V	$V_{GS} = 0\text{ V}, I_{DS} = 12.2\text{ mA}$
Drain source voltage, pulsed <sup>2</sup>	$V_{DS,pulse}$	-	-	750	V	$T_j = 25\text{ °C}; V_{GS} \leq 0\text{ V}; \leq 1\text{ hour of total time}$
		-	-	650	V	$T_j = 125\text{ °C}, V_{GS} \leq 0\text{ V}; \leq 1\text{ hour of total time}$
Switching surge voltage, pulsed <sup>2</sup>	$V_{DS,surge}$	-	-	750	V	DC bus voltage = 700 V; turn off $V_{DS,pulse} = 750\text{ V}$ ; turn on $I_{D,pulse} = 27\text{ A}; T_j = 105\text{ °C}; f \leq 100\text{ kHz}, t \leq 100\text{ secs}$ (10 million pulses)
Continuous current, drain source	$I_D$	-	-	31	A	$T_C = 25\text{ °C}; T_j = T_{j,max}$
		-	-	20		$T_C = 100\text{ °C}; T_j = T_{j,max}$
		-	-	14		$T_C = 125\text{ °C}; T_j = T_{j,max}$
Pulsed current, drain source <sup>3 4</sup>	$I_{D,pulse}$	-	-	60	A	$T_C = 25\text{ °C}; I_G = 26.1\text{ mA}$ ; See Figure 3;
Pulsed current, drain source <sup>4 5</sup>	$I_{D,pulse}$	-	-	35	A	$T_C = 125\text{ °C}; I_G = 26.1\text{ mA}$ ; See Figure 4;
Gate current, continuous <sup>4 5 6</sup>	$I_{G,avg}$	-	-	20	mA	$T_j = -55\text{ °C to }150\text{ °C}$ ;
Gate current, pulsed <sup>4 6</sup>	$I_{G,pulse}$	-	-	2000	mA	$T_j = -55\text{ °C to }150\text{ °C}$ ; $t_{PULSE} = 50\text{ ns}, f = 100\text{ kHz}$
Gate source voltage, continuous <sup>6</sup>	$V_{GS}$	-10	-	-	V	$T_j = -55\text{ °C to }150\text{ °C}$ ;
Gate source voltage, pulsed <sup>6</sup>	$V_{GS,pulse}$	-25	-	-	V	$T_j = -55\text{ °C to }150\text{ °C}$ ; $t_{PULSE} = 50\text{ ns}, f = 100\text{ kHz}$ ; open drain
Power dissipation	$P_{tot}$	-	-	125	W	$T_C = 25\text{ °C}$
Operating temperature	$T_j$	-55	-	150	°C	

<sup>1</sup> All devices are 100% tested at  $I_{DS} = 12.2\text{ mA}$  to assure  $V_{DS} \geq 800\text{ V}$

<sup>2</sup> Provided as measure of robustness under abnormal operating conditions and not recommended for normal operation

<sup>3</sup> Limits derived from product characterization, parameter not measured during production

<sup>4</sup> Ensure that average gate drive current,  $I_{G,avg}$  is  $\leq 20\text{ mA}$ . Please see figure 27 for  $I_{G,avg}$ ,  $I_{G,pulse}$  and  $I_G$  details

<sup>5</sup> Parameter is influenced by rel-requirements. Please contact the local Infineon Sales Office to get an assessment of your application

<sup>6</sup> We recommend using an advanced driving technique to optimize the device performance. Please see gate drive application note for details

Storage temperature	$T_{stg}$	-55	-	150	°C	Max shelf life depends on storage conditions.
Drain-source voltage slew-rate	$dV/dt$			200	V/ns	

## 2 Thermal characteristics

**Table 4 Thermal characteristics**

Parameter	Symbol	Values			Unit	Note/Test Condition
		Min.	Typ.	Max.		
Thermal resistance, junction-case	$R_{thJC}$	-	-	1	°C/W	
Thermal resistance, junction-ambient	$R_{thJA}$	-	-	62	°C/W	Device on PCB, minimum footprint
Thermal resistance, junction-ambient for SMD version	$R_{thJA}$	-	35	45	°C/W	Device on 40mm*40mm* 1.5mm epoxy PCB FR4 with 6cm <sup>2</sup> (one layer, 70µm thickness) copper area for drain connection and cooling. PCB is vertical without air stream cooling.
Reflow soldering temperature	$T_{sold}$	-	-	260	°C	MSL1

### 3 Electrical characteristics

at  $T_j = 25\text{ °C}$ , unless specified otherwise

**Table 5 Static characteristics**

Parameter	Symbol	Values			Unit	Note/Test Condition
		Min.	Typ.	Max.		
Gate threshold voltage	$V_{GS(th)}$	0.9 0.7	1.2 1.0	1.6 1.4	V	$I_{DS} = 2.6\text{ mA}; V_{DS} = 10\text{ V}; T_j = 25\text{ °C}$ $I_{DS} = 2.6\text{ mA}; V_{DS} = 10\text{ V}; T_j = 125\text{ °C}$
Gate-Source reverse clamping voltage	$V_{GS, clamp}$	-	-	-8	V	$I_{GSS} = -1\text{ mA}$
Drain-Source leakage current	$I_{DSS}$	-	1 20	100 -	$\mu\text{A}$	$V_{DS} = 600\text{ V}; V_{GS} = 0\text{ V}; T_j = 25\text{ °C}$ $V_{DS} = 600\text{ V}; V_{GS} = 0\text{ V}; T_j = 150\text{ °C}$
Drain-Source leakage current at application conditions <sup>1</sup>	$I_{DSSapp}$	-	60	-	$\mu\text{A}$	$V_{DS} = 400\text{ V}; V_{GS} = 0\text{ V}; T_j = 125\text{ °C}$
Drain-Source on-state resistance	$R_{DS(on)}$	-	0.055 0.100	0.070 -	$\Omega$	$I_G = 26.1\text{ mA}; I_D = 8\text{ A}; T_j = 25\text{ °C}$ $I_G = 26.1\text{ mA}; I_D = 8\text{ A}; T_j = 150\text{ °C}$
Gate resistance	$R_{G,int}$	-	0.78	-	$\Omega$	LCR impedance measurement; $f = f_{res}$ ; open drain;

**Table 6 Dynamic characteristics**

Parameter	Symbol	Values			Unit	Note/Test Condition
		Min.	Typ.	Max.		
Input capacitance	$C_{iss}$	-	380	-	pF	$V_{GS} = 0\text{ V}; V_{DS} = 400\text{ V};$ $f = 1\text{ MHz}$
Output capacitance	$C_{oss}$	-	72	-	pF	$V_{GS} = 0\text{ V}; V_{DS} = 400\text{ V};$ $f = 1\text{ MHz}$
Reverse Transfer capacitance	$C_{rss}$	-	0.3	-	pF	$V_{GS} = 0\text{ V}; V_{DS} = 400\text{ V};$ $f = 1\text{ MHz}$
Effective output capacitance, energy related <sup>2</sup>	$C_{o(er)}$	-	80	-	pF	$V_{DS} = 0\text{ to }400\text{ V}$
Effective output capacitance, time related <sup>3</sup>	$C_{o(tr)}$	-	102.5	-	pF	$V_{GS} = 0\text{ V}; V_{DS} = 0\text{ to }400\text{ V};$ $I_D = \text{const}$
Output charge	$Q_{oss}$	-	41	-	nC	$V_{DS} = 0\text{ to }400\text{ V}$
Turn- on delay time	$t_{d(on)}$	-	10	-	ns	see Figure 23
Turn- off delay time	$t_{d(off)}$	-	14	-	ns	see Figure 23
Rise time	$t_r$	-	8	-	ns	see Figure 23
Fall time	$t_f$	-	15	-	ns	see Figure 23

<sup>1</sup> Parameter represents end of use leakage in applications

<sup>2</sup>  $C_{o(er)}$  is a fixed capacitance that gives the same stored energy as  $C_{oss}$  while  $V_{DS}$  is rising from 0 to 400 V

<sup>3</sup>  $C_{o(tr)}$  is a fixed capacitance that gives the same charging time as  $C_{oss}$  while  $V_{DS}$  is rising from 0 to 400 V

**Table 7 Gate charge characteristics**

Parameter	Symbol	Values			Unit	Note/Test Condition
		Min.	Typ.	Max.		
Gate charge	$Q_G$	-	5.8	-	nC	$I_{GS} = 0$ to 10 mA; $V_{DS} = 400$ V; $I_D = 8$ A

**Table 8 Reverse conduction characteristics**

Parameter	Symbol	Values			Unit	Note/Test Condition
		Min.	Typ.	Max.		
Source-Drain reverse voltage	$V_{SD}$	-	2.2	2.5	V	$V_{GS} = 0$ V; $I_{SD} = 8$ A
Pulsed current, reverse	$I_{S,pulse}$	-	-	60	A	$I_G = 26.1$ mA
Reverse recovery charge	$Q_{rr}^1$	-	0	-	nC	$I_S = 8$ A, $V_{DS} = 400$ V
Reverse recovery time	$t_{rr}$	-	0	-	ns	
Peak reverse recovery current	$I_{rrm}$	-	0	-	A	

<sup>1</sup> Excluding  $Q_{oss}$   
Final Data Sheet

## 4 Electrical characteristics diagrams

at  $T_j = 25\text{ °C}$ , unless specified otherwise

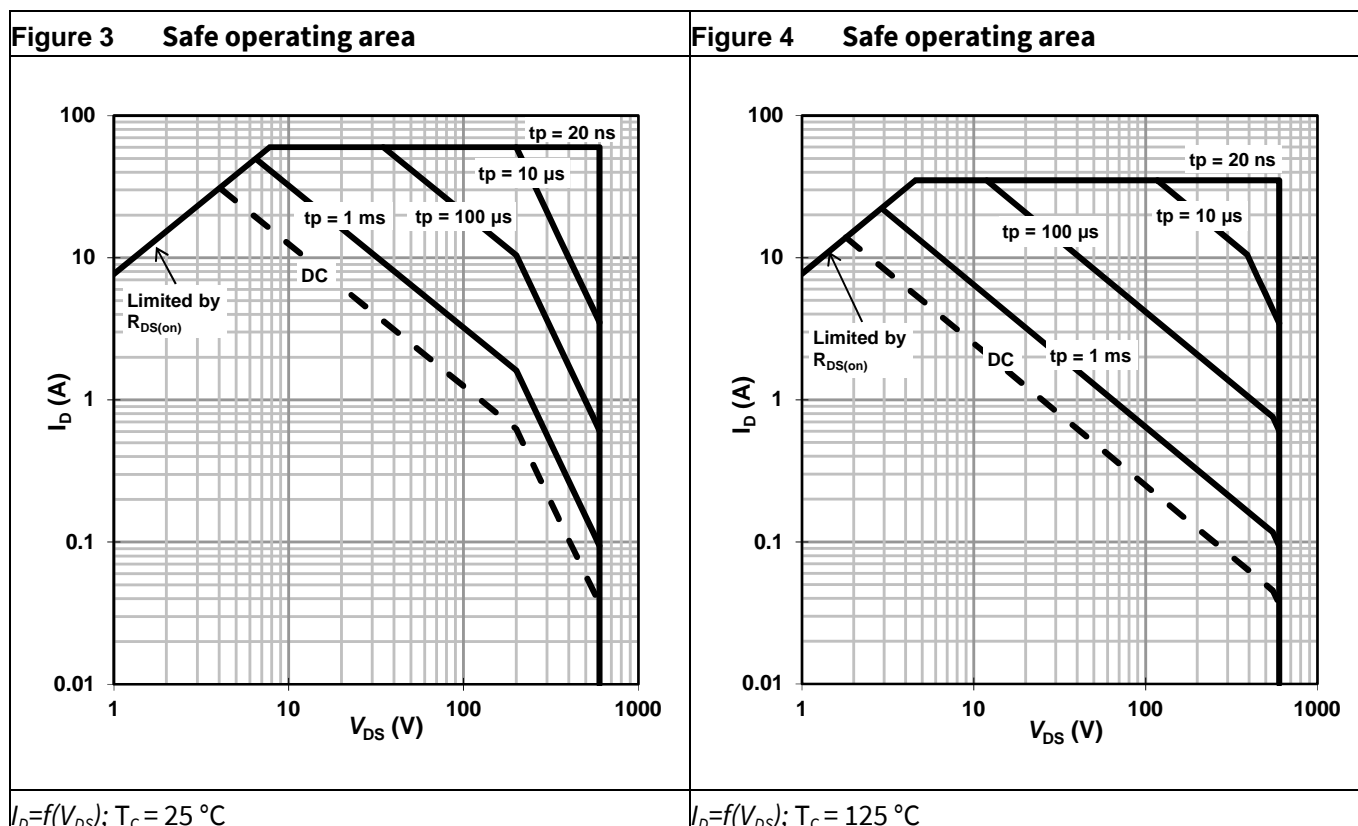
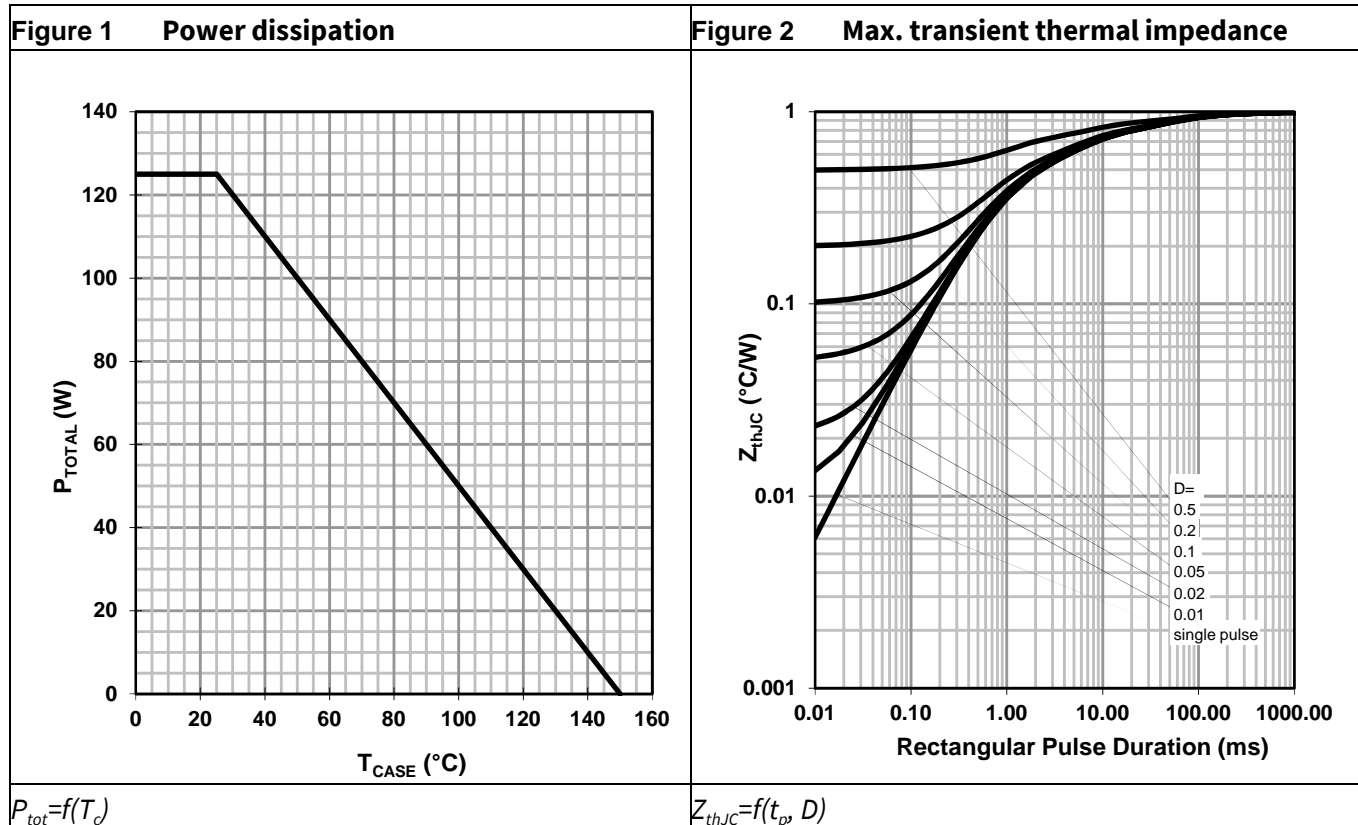
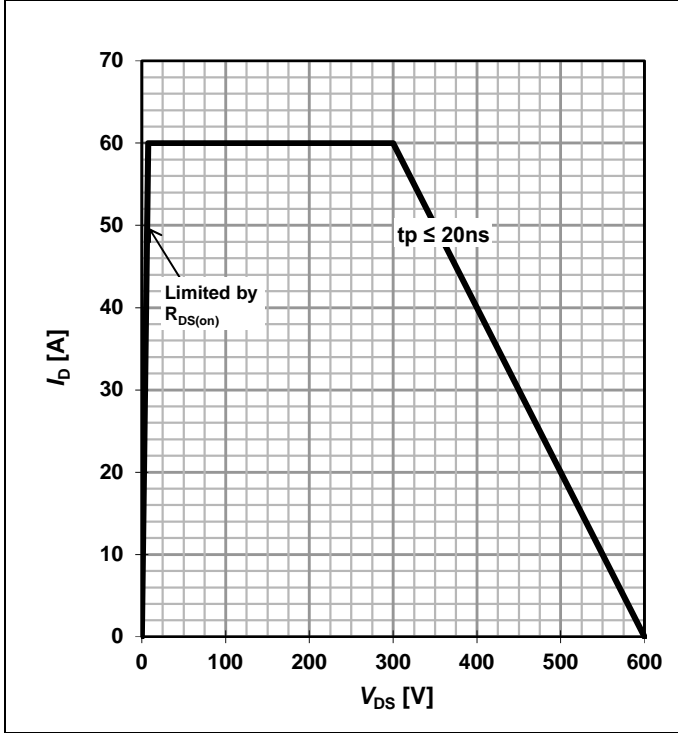
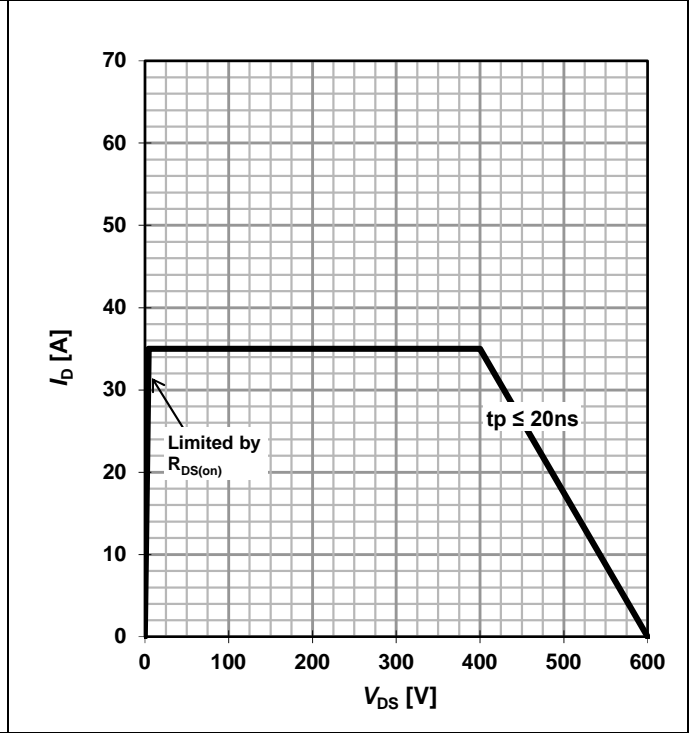


Figure 5 Repetitive safe operating area<sup>1</sup>



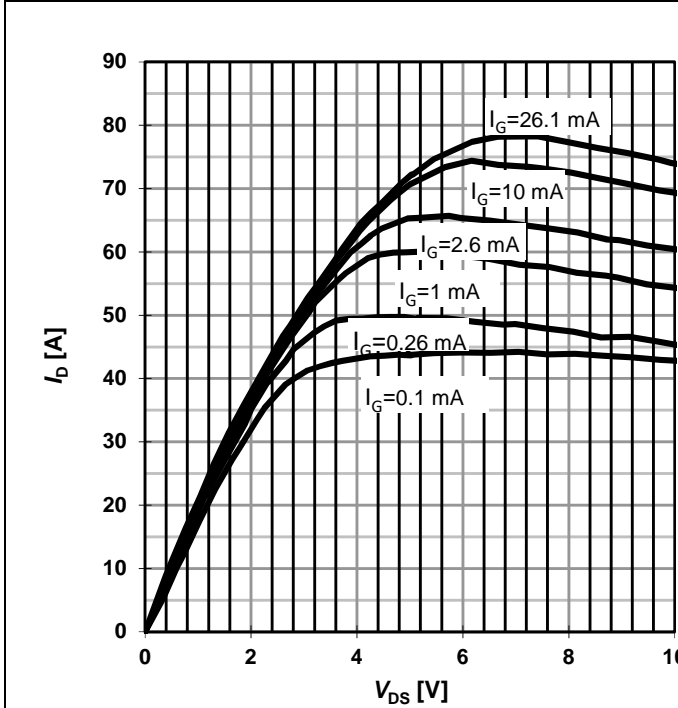
$T_c = 25\text{ °C}; T_j \leq 150\text{ °C}$

Figure 6 Repetitive safe operating area<sup>1</sup>



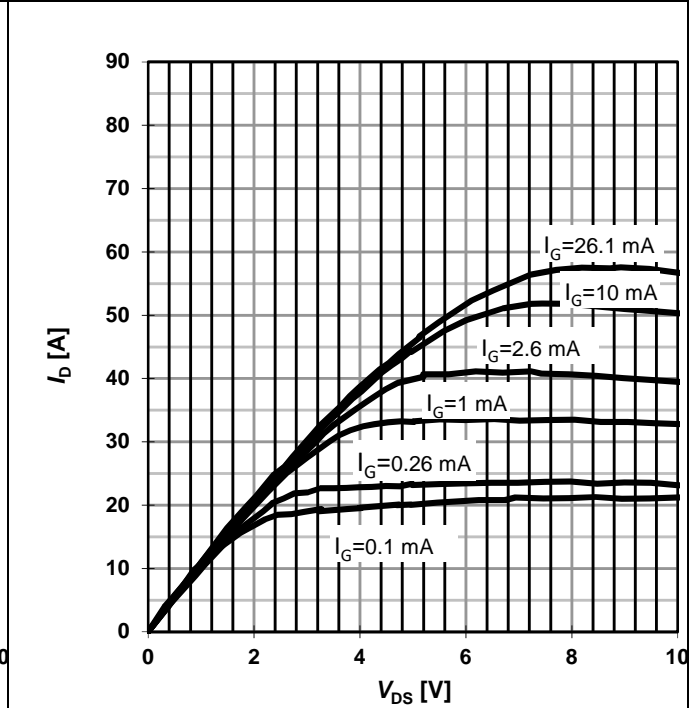
$T_c = 125\text{ °C}; T_j \leq 150\text{ °C}$

Figure 7 Typ. output characteristics



$I_D = f(V_{DS}, I_G); T_j = 25\text{ °C}$

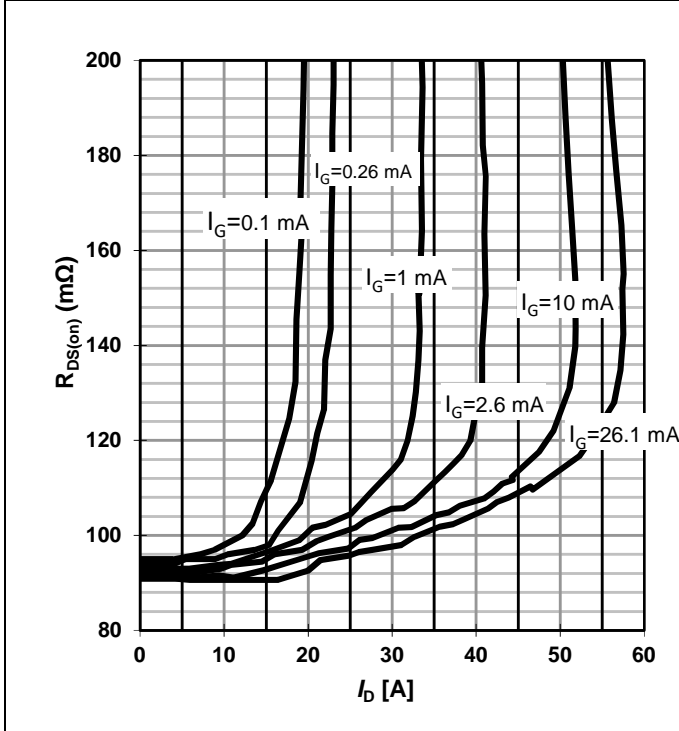
Figure 8 Typ. output characteristics



$I_D = f(V_{DS}, I_G); T_j = 125\text{ °C}$

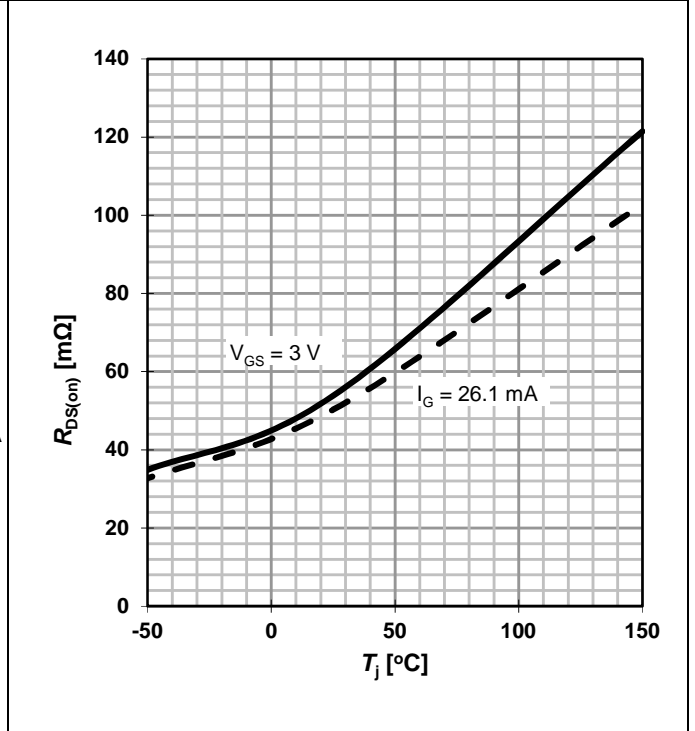
<sup>1</sup> Parameter is influenced by rel-requirements. Please contact the local Infineon Sales Office to get an assessment of your application.

Figure 9 Typ. Drain-source on-state resistance



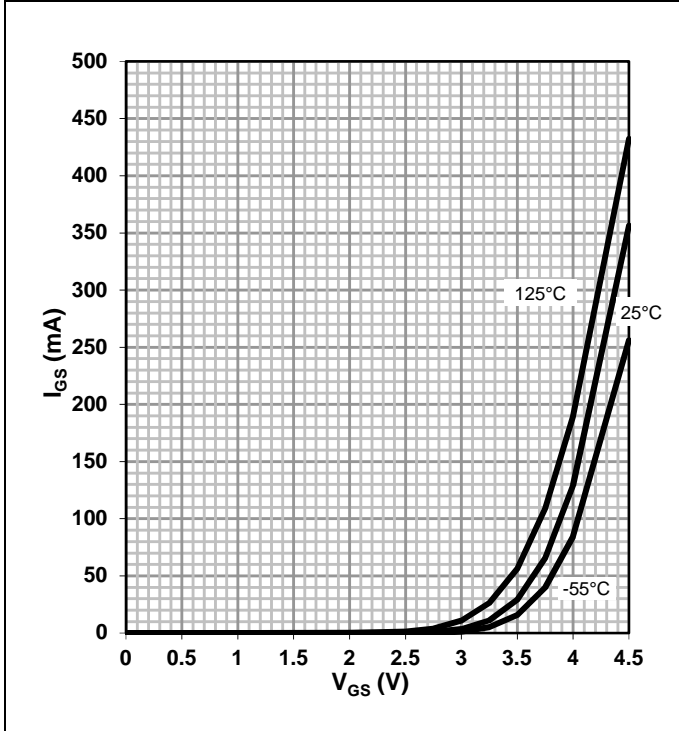
$R_{DS(on)} = f(I_D, I_G); T_j = 125^\circ\text{C}$

Figure 10 Drain-source on-state resistance



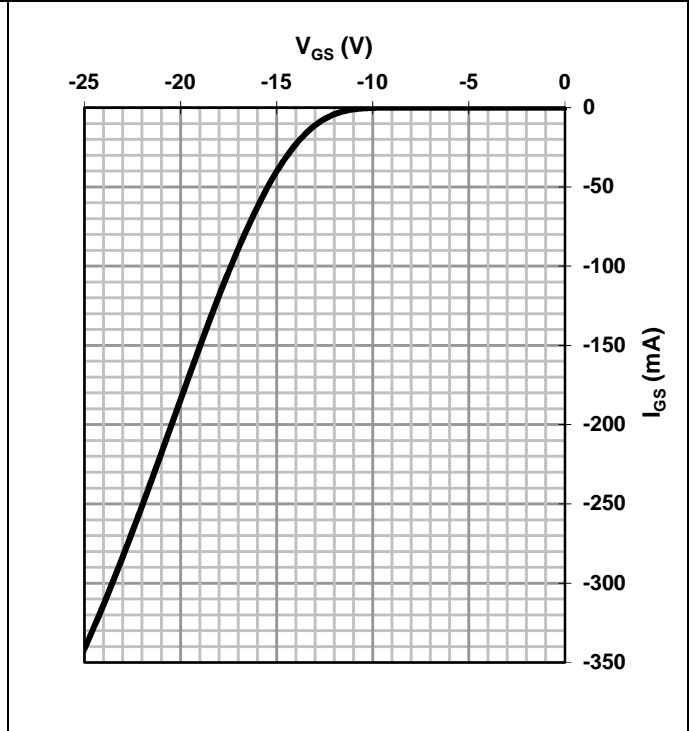
$R_{DS(on)} = f(T_j); I_D = 8\text{ A}$

Figure 11 Typ. gate characteristics forward



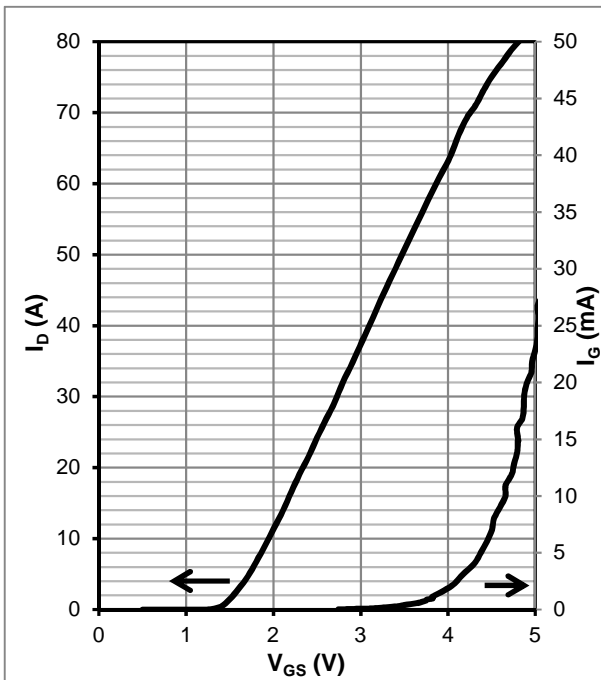
$I_{GS} = f(V_{GS}, T_j); \text{open drain}$

Figure 12 Typ. gate characteristics reverse



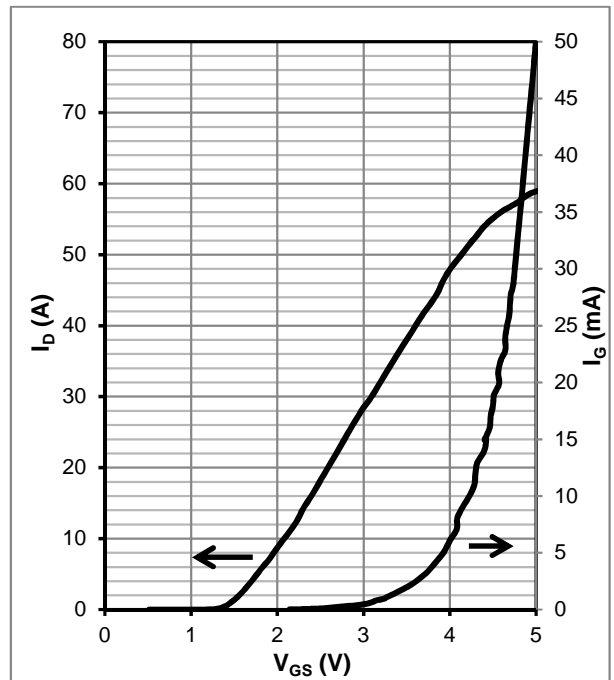
$I_{GS} = f(V_{GS}); T_j = 25^\circ\text{C}$

Figure 13 Typ. transfer characteristics



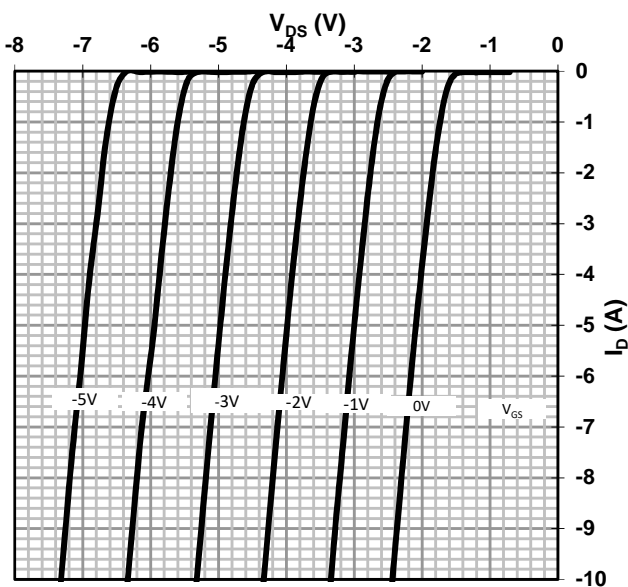
$I_D, I_G = f(V_{GS}); V_{DS} = 8 \text{ V}; T_j = 25 \text{ }^\circ\text{C}$

Figure 14 Typ. transfer characteristics



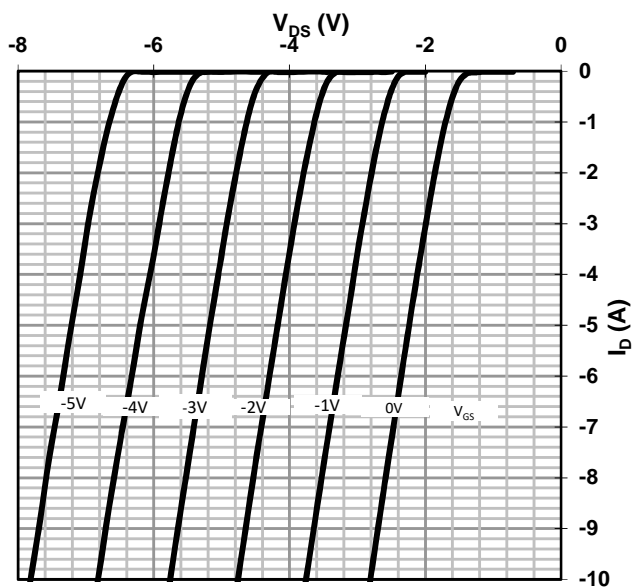
$I_D, I_G = f(V_{GS}); V_{DS} = 8 \text{ V}; T_j = 125 \text{ }^\circ\text{C}$

Figure 15 Typ. channel reverse characteristics



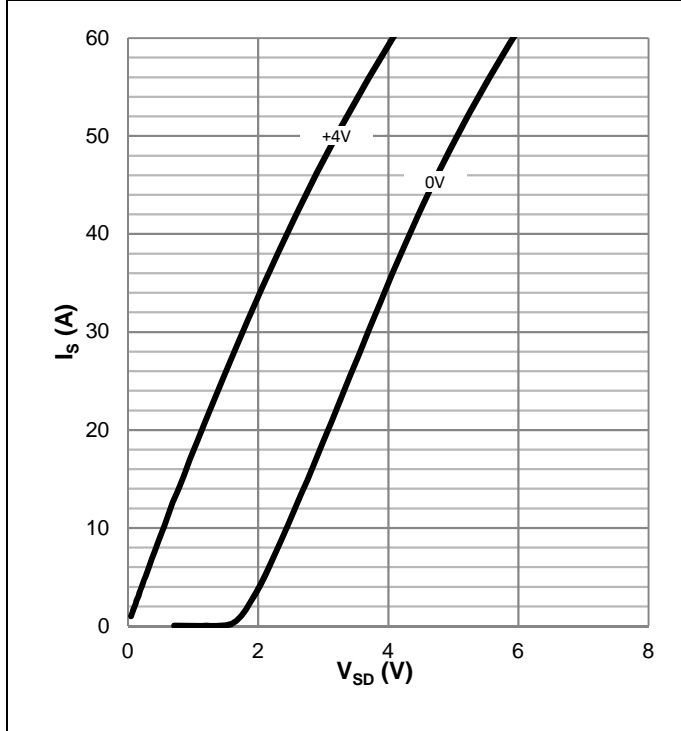
$V_{DS} = f(I_D, V_{GS}); T_j = 25 \text{ }^\circ\text{C}$

Figure 16 Typ. channel reverse characteristics



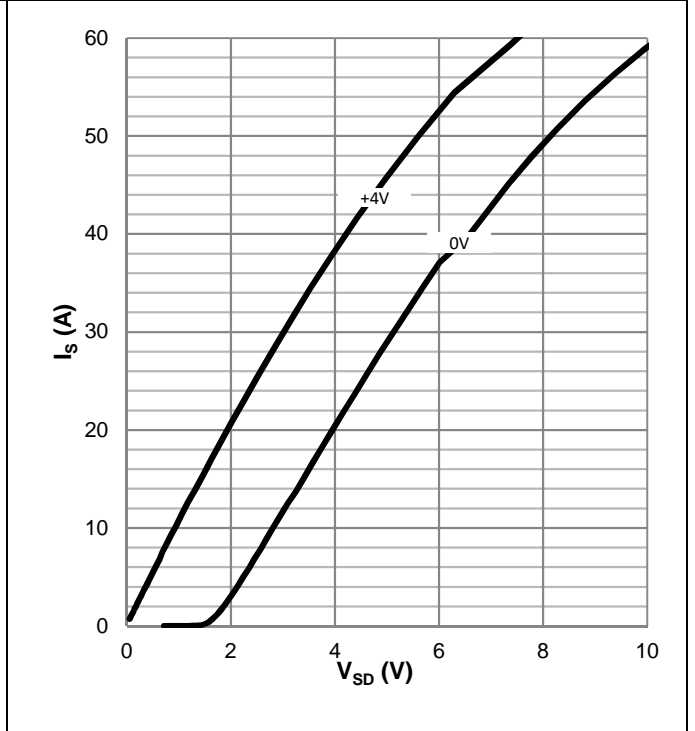
$V_{DS} = f(I_D, V_{GS}); T_j = 125 \text{ }^\circ\text{C}$

**Figure 17 Typ. channel reverse characteristics**



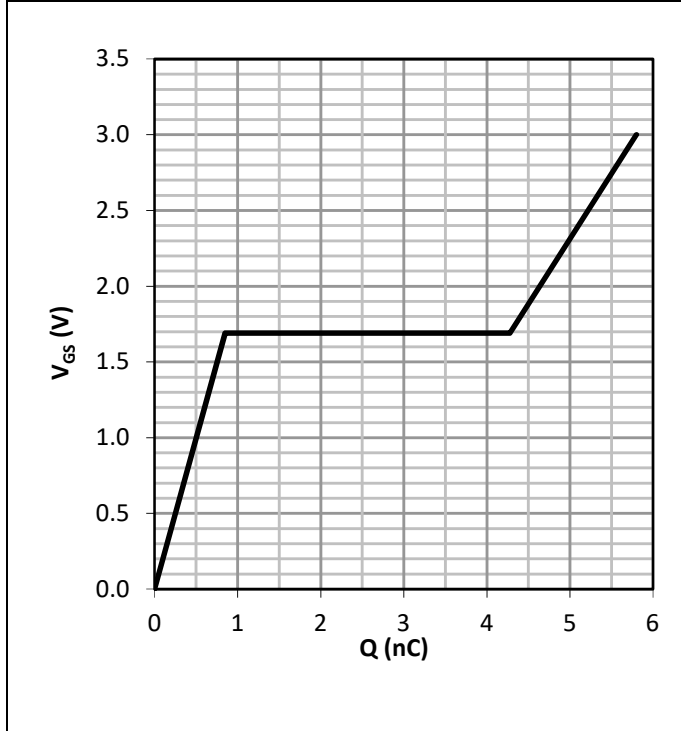
$I_D = f(V_{DS}, V_{GS}); T_j = 25\text{ °C}$

**Figure 18 Typ. channel reverse characteristics**



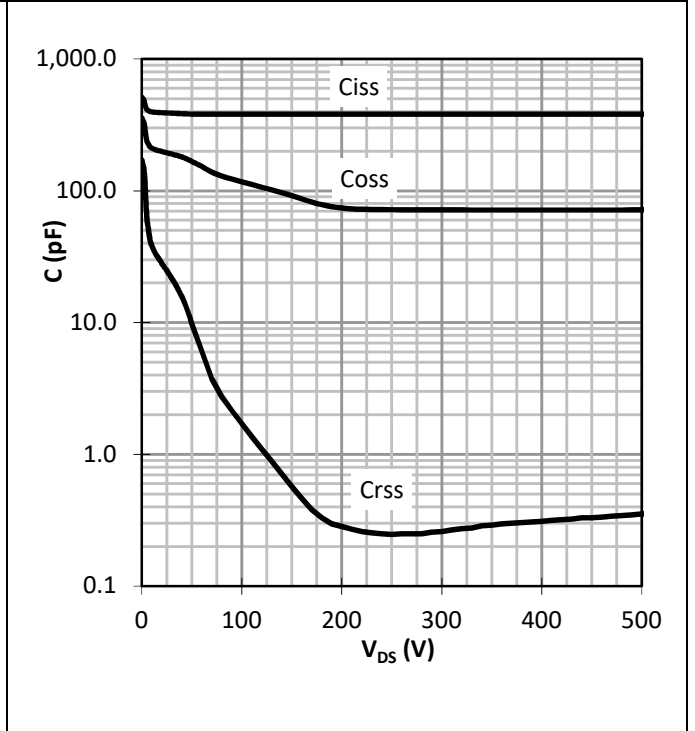
$I_D = f(V_{DS}, V_{GS}); T_j = 125\text{ °C}$

**Figure 19 Typ. gate charge**

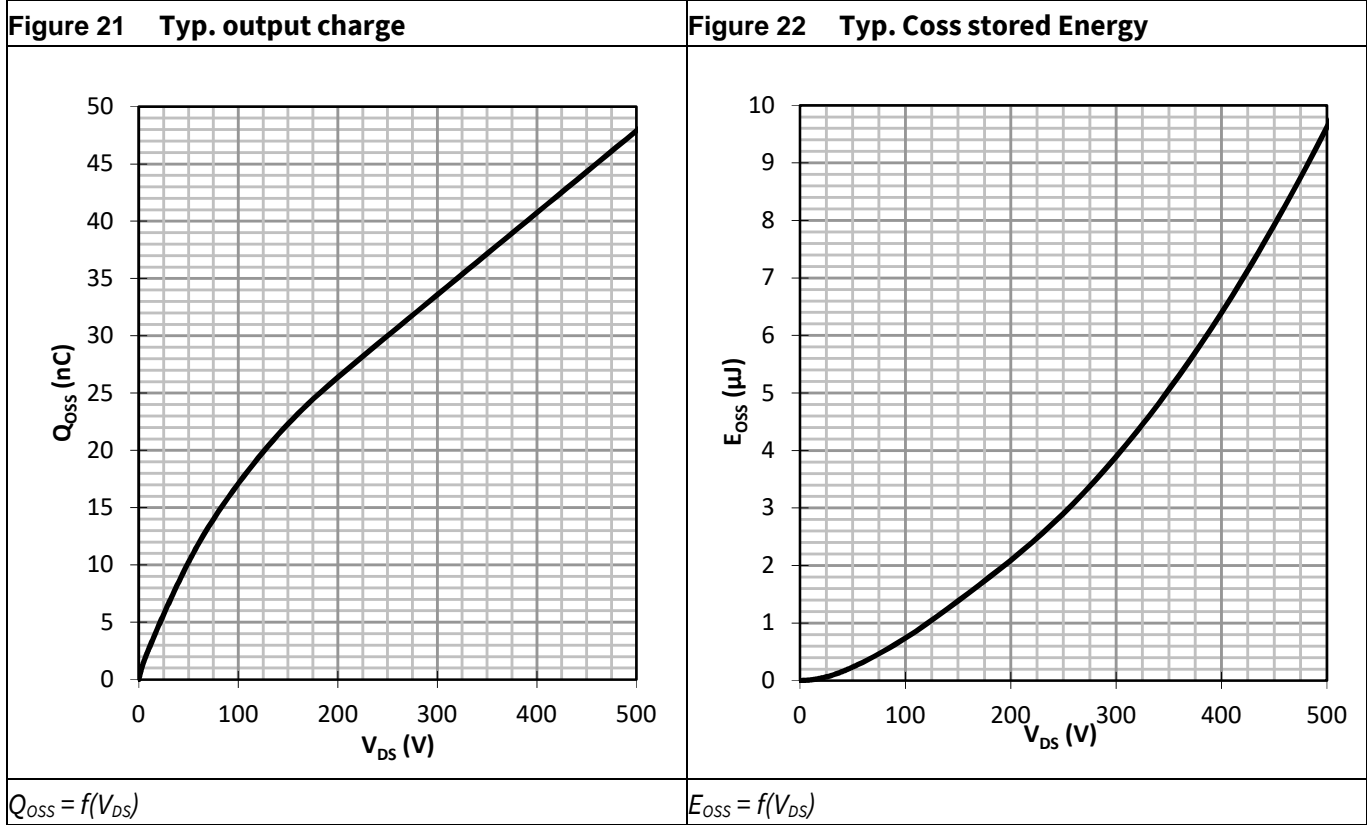


$V_{GS} = f(Q_G); V_{DCLINK} = 400\text{ V}; I_D = 8\text{ A}$

**Figure 20 Typ. capacitances**

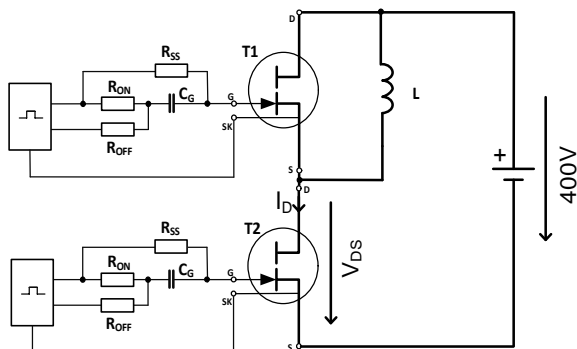


$C_{xSS} = f(V_{DS})$



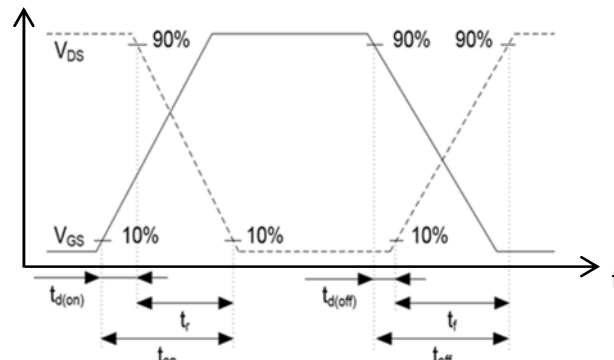
## 5 Test Circuits

**Figure 23 Switching times with inductive load**

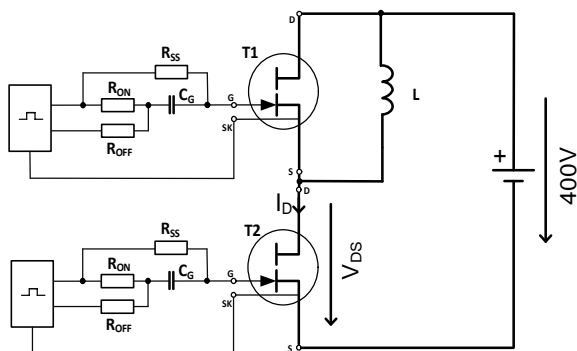


$I_D = 8A$ ,  $R_{ON} = 5\ \Omega$ ;  $R_{OFF} = 5\ \Omega$ ;  $R_{SS} = 300\ \Omega$ ;  
 $C_G = 3.3\ nF$ ;  $V_{DRV} = 12V$

**Figure 24 Switching times waveform**

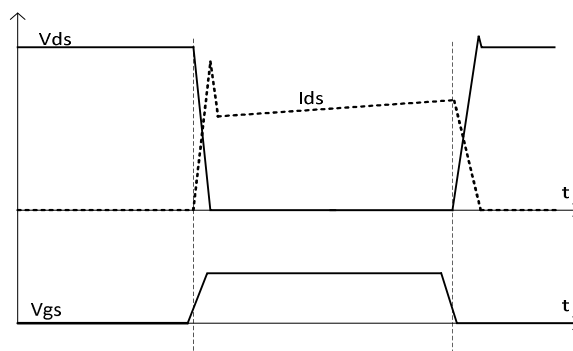


**Figure 25 Reverse Channel Characteristics Test**



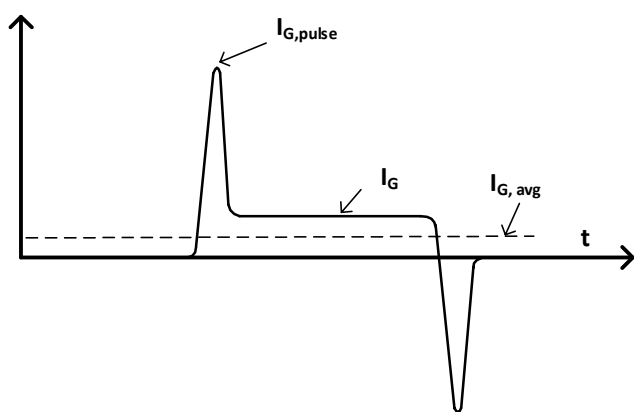
$I_D = 8A$ ,  $R_{ON} = 5\ \Omega$ ;  $R_{OFF} = 5\ \Omega$ ;  $R_{SS} = 300\ \Omega$ ;  
 $C_G = 3.3\ nF$ ;  $V_{DRV} = 12V$

**Figure 26 Typical Reverse Channel Recovery**



The recovery charge is  $Q_{OSS}$  only, no additional  $Q_{rr}$

**Figure 27 Gate current switching waveform**



## 6 Package Outlines

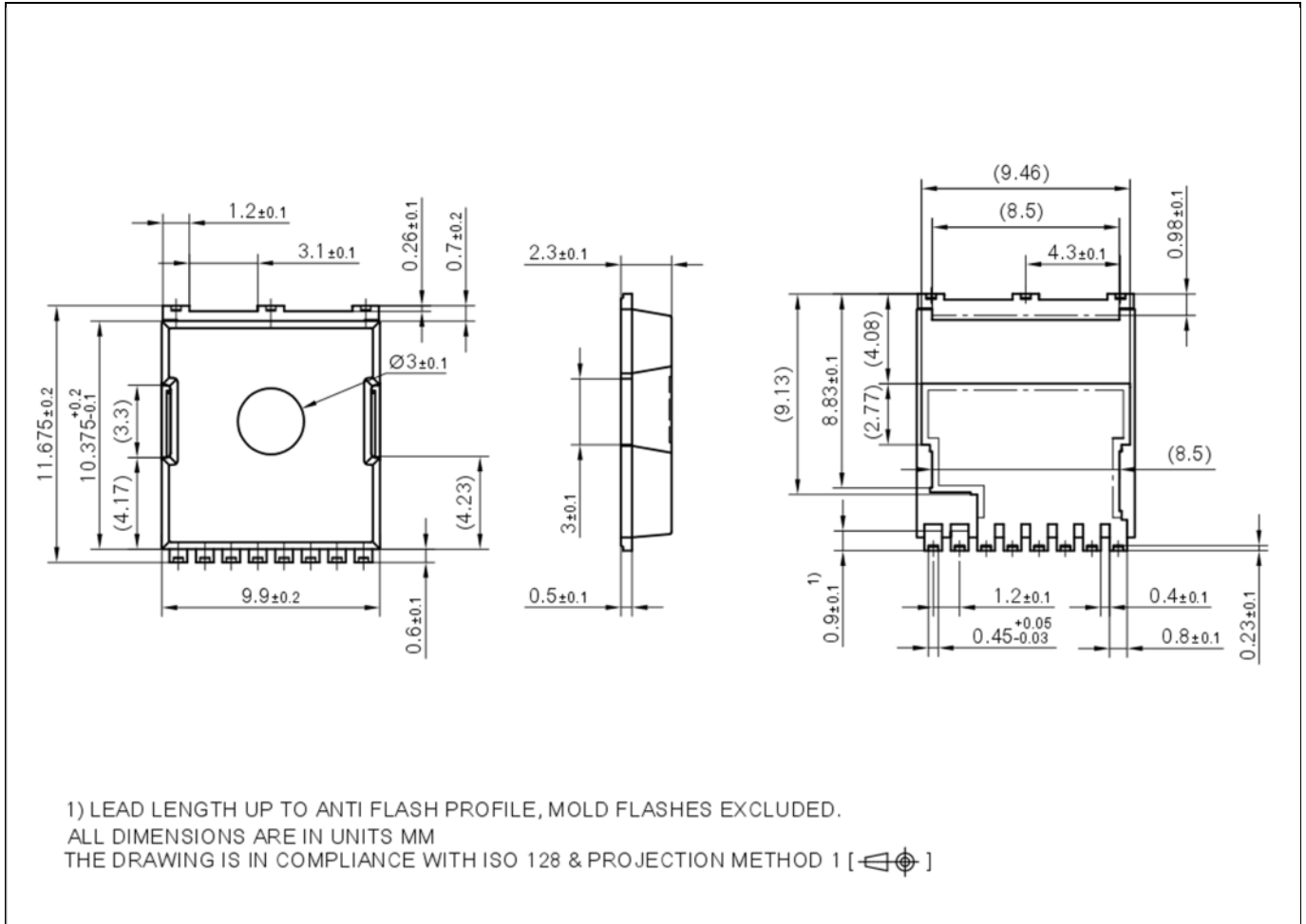


Figure 28 PG-HSOF-8-3 Package Outline, dimensions (mm)

## 7 Appendix A

Table 9 Related links

- IFX CoolGaN™ webpage: [www.infineon.com/why-coolgan](http://www.infineon.com/why-coolgan)
- IFX CoolGaN™ reliability white paper: [www.infineon.com/gan-reliability](http://www.infineon.com/gan-reliability)
- IFX CoolGaN™ gate drive application note: [www.infineon.com/driving-coolgan](http://www.infineon.com/driving-coolgan)
- IFX CoolGaN™ applications information:
  - [www.infineon.com/gan-in-server-telecom](http://www.infineon.com/gan-in-server-telecom)
  - [www.infineon.com/gan-in-wirelesscharging](http://www.infineon.com/gan-in-wirelesscharging)
  - [www.infineon.com/gan-in-audio](http://www.infineon.com/gan-in-audio)
  - [www.infineon.com/gan-in-adapter-charger](http://www.infineon.com/gan-in-adapter-charger)

## 8 Revision History

### Major changes since the last revision

Revision	Date	Description of change
2.0	2018-04-24	Final version release
2.1	2018-10-12	Updated application section; added Appendix A and Fig. 27; updated maximum rating table footnotes, switching times and figures.
2.11	2020-01-16	Added $V_{DS,bd}$ , $V_{DS,pulse}$ , $V_{DS,surge}$ specifications in maximum ratings table of page3
2.12	2020-05-29	Updated to MSL1 in table 4
2.13	2021-04-27	Updated $I_{GSS}$ specification at 125°C to -2 mA in table 5; updated switching times and related test conditions
2.14	2021-10-26	Replaced $I_{GSS}$ specification with $V_{GS,clamp}$ in table 5

#### Other Trademarks

All referenced product or service names and trademarks are the property of their respective owners.

#### We Listen to Your Comments

Any information within this document that you feel is wrong, unclear or missing at all? Your feedback will help us to continuously improve the quality of this document. Please send your proposal (including a reference to this document) to: [erratum@infineon.com](mailto:erratum@infineon.com)

**Published by**  
**Infineon Technologies AG**  
**81726 München, Germany**  
**© 2021 Infineon Technologies AG**  
**All Rights Reserved.**

#### Legal Disclaimer

The information given in this document shall in no event be regarded as a guarantee of conditions or characteristics ("Beschaffungsgarantie").

With respect to any examples, hints or any typical values stated herein and/or any information regarding the application of the product, Infineon Technologies hereby disclaims any and all warranties and liabilities of any kind, including without limitation warranties of non-infringement of intellectual property rights of any third party.

In addition, any information given in this document is subject to customer's compliance with its obligations stated in this document and any applicable legal requirements, norms and standards concerning customer's products and any use of the product of Infineon Technologies in customer's applications.

The data contained in this document is exclusively intended for technically trained staff. It is the responsibility of customer's technical departments to evaluate the suitability of the product for the intended application and the completeness of the product information given in this document with respect to such application.

#### Information

For further information on technology, delivery terms and conditions and prices please contact your nearest Infineon Technologies Office ([www.infineon.com](http://www.infineon.com)).

#### Warnings

Due to technical requirements, components may contain dangerous substances. For information on the types in question, please contact the nearest Infineon Technologies Office.

The Infineon Technologies component described in this Data Sheet may be used in life-support devices or systems and/or automotive, aviation and aerospace applications or systems only with the express written approval of Infineon Technologies, if a failure of such components can reasonably be expected to cause the failure of that life-support, automotive, aviation and aerospace device or system or to affect the safety or effectiveness of that device or system. Life support devices or systems are intended to be implanted in the human body or to support and/or maintain and sustain and/or protect human life. If they fail, it is reasonable to assume that the health of the user or other persons may be endangered.