

GLASS PASSIVATED BRIDGE RECTIFIERS

REVERSE VOLTAGE - **50 to 1000** Volts
FORWARD CURRENT - **2.0** Amperes

FEATURES

- Rating to 1000V PRV
- Ideal for printed circuit board
- Reliable low cost construction utilizing molded plastic technique
- The plastic material has UL flammability classification 94V#0

KBP

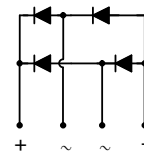
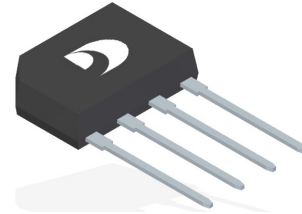

MECHANICAL DATA

- Polarity : As marked on body
- Weight : 0.05 ounces, 1.52 grams
- Mounting position : Any

MAXIMUM RATINGS AND ELECTRICAL CHARACTERISTICS

Ratings at 25°C ambient temperature unless otherwise specified.

| CHARACTERISTICS | SYMBOL | KBP 2005 | KBP 201 | KBP 202 | KBP 204 | KBP 206 | KBP 208 | KBP 210 | UNIT |
|---|-----------------|-------------|------------|------------|------------|------------|------------|------------|----------------------|
| Maximum Repetitive Peak Reverse Voltage | V_{RRM} | 50 | 100 | 200 | 400 | 600 | 800 | 1000 | V |
| Maximum RMS Voltage | V_{RMS} | 35 | 70 | 140 | 280 | 420 | 560 | 700 | V |
| Maximum DC Blocking Voltage | V_{DC} | 50 | 100 | 200 | 400 | 600 | 800 | 1000 | V |
| Maximum Average Forward Rectified Current @ $T_C=100^\circ\text{C}$ | $I_{(AV)}$ | 2.0 | | | | | | | A |
| Peak Forward Surge Current 8.3ms single half sine-wave @ $T_j = 25^\circ\text{C}$ | I_{FSM} | 45 | | | | | | | A |
| Peak Forward Surge Current 1.0ms single half sine-wave @ $T_j = 125^\circ\text{C}$ | I_{FSM} | 80 100 | | | | | | | A |
| Maximum Forward Voltage at 2.0A DC | V_F | 1.1 | | | | | | | V |
| Maximum DC Reverse Current at rated Blocking Voltage @ $T_j=25^\circ\text{C}$ @ $T_j=125^\circ\text{C}$ | I_R | 5.0 500 | | | | | | | μA |
| I^2t Rating for fusing ($3\text{ms} \leq t \leq 8.3\text{ms}$) | I^2t | 17.5 | | | | | | | A^2S |
| Typical Junction Capacitance per element (Note 1) | C_J | 25 | | | | | | | pF |
| Typical thermal resistance (Note 2) | $R_{\theta JC}$ | 10 | | | | | | | $^\circ\text{C/W}$ |
| | $R_{\theta JL}$ | 18 | | | | | | | |
| | $R_{\theta JA}$ | 40 | | | | | | | |
| Operation Temperature Range | T_J | -55 to 150 | | | | | | | $^\circ\text{C}$ |
| Storage Temperature Range | T_{STG} | -55 to 150 | | | | | | | $^\circ\text{C}$ |

Note: (1) Measured at 1.0MHz and applied reverse voltage of 4.0V DC.

(2) Thermal Resistance Junction to Case, Lead and Ambient.

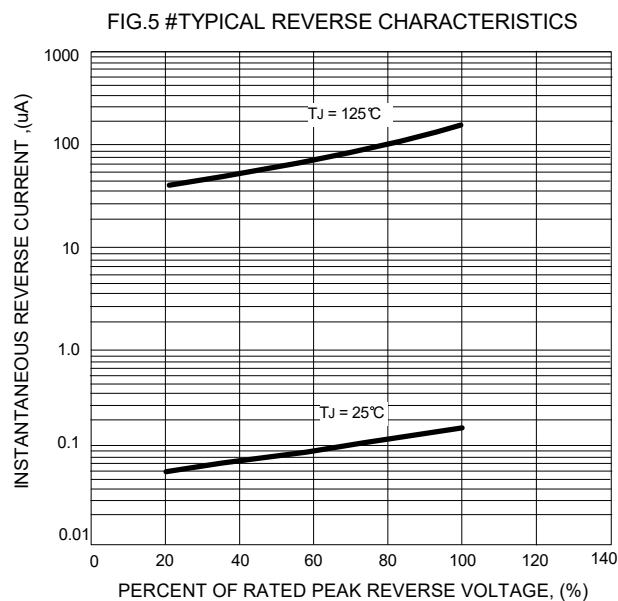
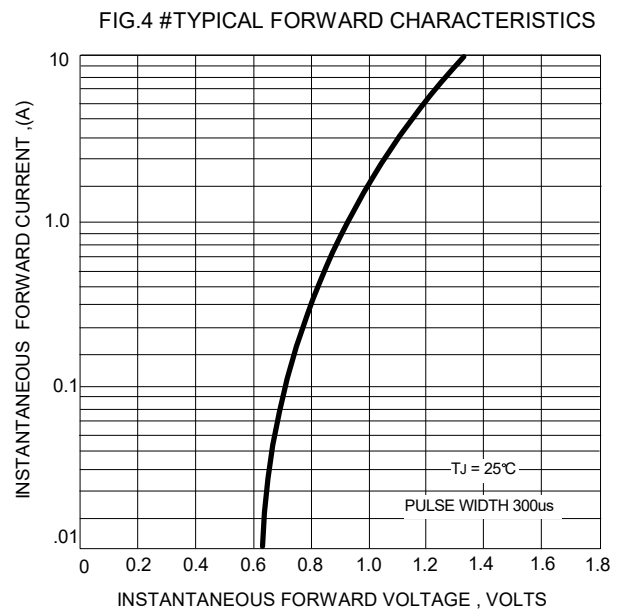
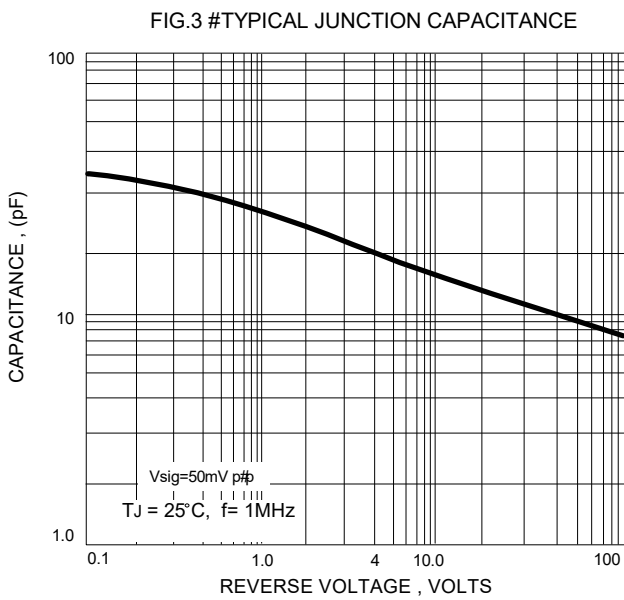
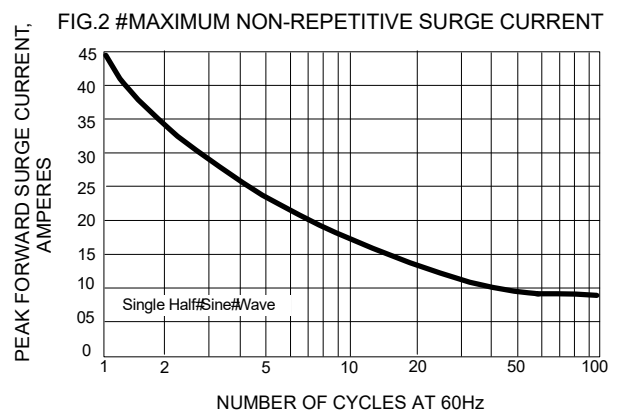
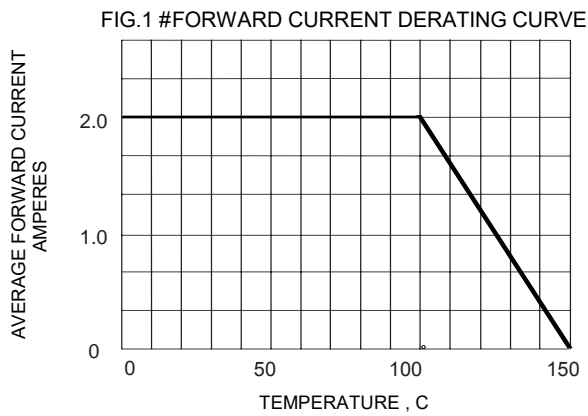

KBP Package Outline Dimensions

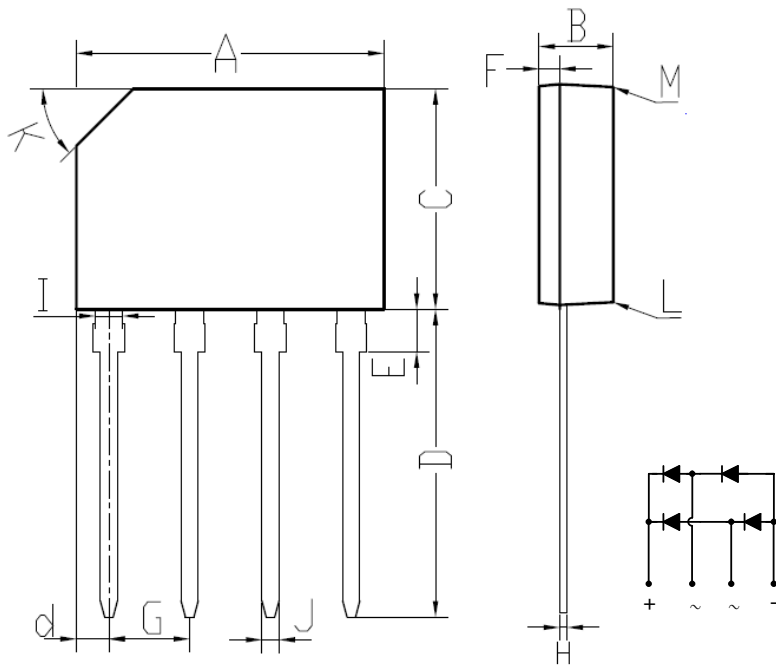

| KBP | | |
|------------------------------|-----------------|-------|
| DIM. | MIN. | MAX. |
| A | 14.25 | 14.75 |
| B | 3.35 | 3.65 |
| C | 10.20 | 10.60 |
| D | 14.25 | 14.73 |
| d | 1.40 | 1.70 |
| E | 1.80 | 2.20 |
| F | 0.80 | 1.10 |
| G | 3.56 | 4.06 |
| H | 0.35 | 0.55 |
| I | 1.22 | 1.42 |
| J | 0.76 | 0.86 |
| K | 2.7 x 45° (Typ) | |
| L | # | 3° |
| M | # | 2° |
| All Dimensions in millimeter | | |