



PESD2ETH1G-T

ESD protection for In-vehicle networks

7 February 2020

Product data sheet

1. General description

Fully OPEN Alliance 100BASE-T1 and 1000BASE-T1 compliant Electrostatic discharge (ESD) protection device in a small SOT23 surface-mounted plastic package designed to protect two automotive in-vehicle network bus lines from the damage caused by ESD and other transients.

2. Features and benefits

- Fully OPEN Alliance 100BASE-T1 and 1000BASE-T1 compliant
- High trigger voltage: $V_{t1} = 100$ V min.
- Low capacitance: $C_d < 2$ pF
- ESD protection up to 30 kV (IEC 61000-4-2)
- 1000 contact discharges (OPEN Alliance specification) with 15 kV (IEC 61000-4-2)
- AEC-Q101 qualified / automotive grade

3. Applications

ESD protection for in-vehicle network lines In-automotive environments

- OPEN Alliance 100/1000BASE-T1 Ethernet
- Low-Voltage Differential Signaling (LVDS) automotive

4. Quick reference data

Table 1. Quick reference data

Symbol	Parameter	Conditions		Min	Typ	Max	Unit
V_{RWM}	reverse standoff voltage	$T_{amb} = 25$ °C		-	-	24	V
C_d	diode capacitance	$f = 1$ MHz; $V_R = 0$ V; $T_{amb} = 25$ °C		-	1.8	2	pF
V_{t1}	trigger voltage	$T_{amb} = 25$ °C	[1]	100	140	-	V
V_{ESD}	electrostatic discharge voltage	IEC 61000-4-2; contact discharge	[2] [3]	30	-	-	kV
		1000 contact discharges (IEC 61000-4-2); OPEN Alliance specification	[3]	15	-	-	kV

[1] Non-repetitive current pulse, Transmission Line Pulse (TLP); square pulse; ANSI / ESD STM5.5.1-2008

[2] Device stressed with ten non-repetitive ESD pulses.

[3] Measured from pin 1 or 2 to pin 3.

5. Pinning information

Table 2. Pinning information

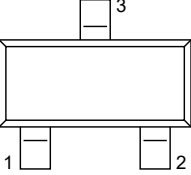
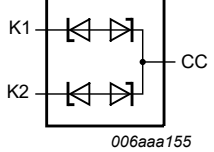
Pin	Symbol	Description	Simplified outline	Graphic symbol
1	K	cathode	 <p style="text-align: center;">SOT23</p>	 <p style="text-align: center;">006aaa155</p>
2	K	cathode		
3	CC	common cathode		

6. Ordering information

Table 3. Ordering information

Type number	Package		
	Name	Description	Version
PESD2ETH1G-T	SOT23	plastic, surface-mounted package; 3 terminals; 1.9 mm pitch; 2.9 mm x 1.3 mm x 1 mm body	SOT23

7. Marking

Table 4. Marking codes

Type number	Marking code ^[1]
PESD2ETH1G-T	%HK

[1] % = placeholder for manufacturing site code

8. Limiting values

Table 5. Limiting values

In accordance with the Absolute Maximum Rating System (IEC60134)

Symbol	Parameter	Conditions		Min	Max	Unit
I_{PPM}	rated peak pulse current	$t_p = 8/20 \mu s$	[1] [2]	-	2.3	A
T_j	junction temperature			-	150	°C
T_{amb}	ambient temperature			-55	150	°C
T_{stg}	storage temperature			-65	150	°C
V_{ESD}	electrostatic discharge voltage	IEC 61000-4-2; contact discharge	[3] [2]	30	-	kV
		ISO 10605; contact discharge; C = 150 pF; R = 330 Ω	[3] [2]	30	-	kV
		ISO 10605; contact discharge; C = 330 pF; R = 330 Ω	[3] [2]	30	-	kV
		1000 contact discharges (IEC 61000-4-2); OPEN Alliance specification	[2]	15	-	kV

- [1] Device stressed with 8/20 μs exponential decay waveform according to IEC 61000-4-5.
- [2] Measured from pin 1 or 2 to pin 3.
- [3] Device stressed with ten non-repetitive ESD pulses.

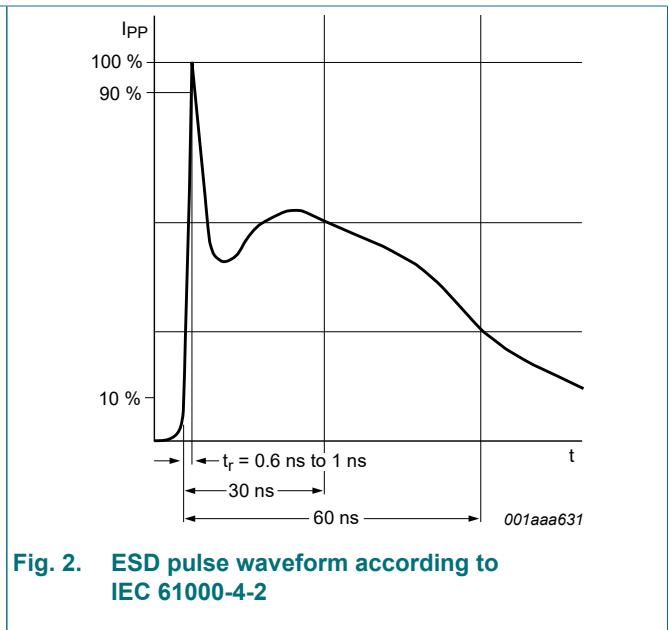
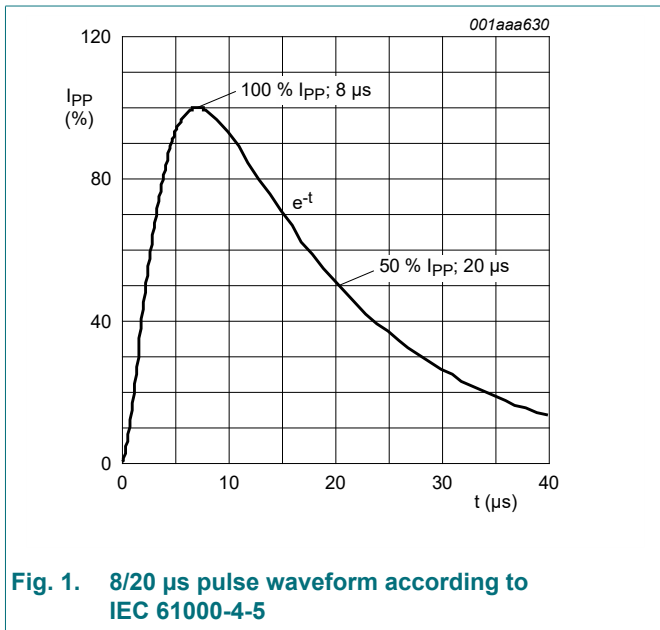

9. Characteristics

Table 6. Characteristics

Symbol	Parameter	Conditions	Min	Typ	Max	Unit
V_{RWM}	reverse standoff voltage	$T_{amb} = 25\text{ }^{\circ}\text{C}$	-	-	24	V
V_h	holding voltage		[1]	28	-	V
V_{t1}	trigger voltage		[1]	100	140	V
I_{RM}	reverse leakage current	$V_{RWM} = 24\text{ V}; V_R = 0\text{ V}; T_{amb} = 25\text{ }^{\circ}\text{C}$	-	1	100	nA
C_d	diode capacitance	$f = 1\text{ MHz}; V_R = 0\text{ V}; T_{amb} = 25\text{ }^{\circ}\text{C}$	-	1.8	2	pF
$\Delta C_d/C_d$	diode capacitance matching		[2]	0.5	-	%
		$f = 1\text{ MHz}; V_R = 2.5\text{ V}; T_{amb} = 25\text{ }^{\circ}\text{C}$	[2]	0.5	-	%
R_{dyn}	dynamic resistance	$I_R = 40\text{ A}; T_{amb} = 25\text{ }^{\circ}\text{C}$	[1]	0.6	-	Ω

- [1] Non-repetitive current pulse, Transmission Line Pulse (TLP); square pulse; ANSI / ESD STM5.5.1-2008
- [2] ΔC_d is the difference of the capacitance measured between pin 1 and pin 3 and the capacitance measured between pin 2 and pin 3.

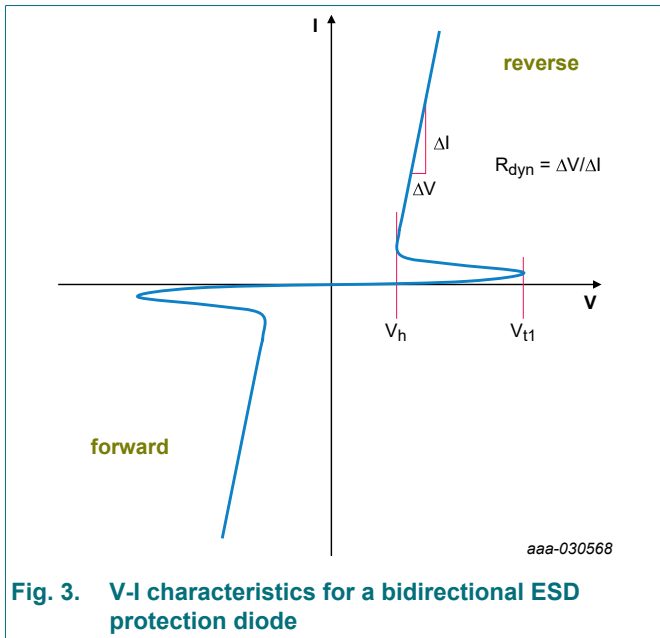

Fig. 3. V-I characteristics for a bidirectional ESD protection diode

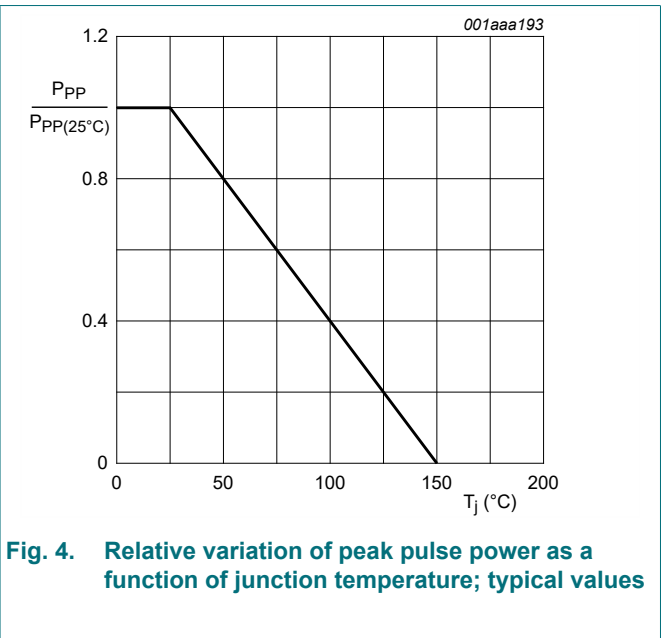
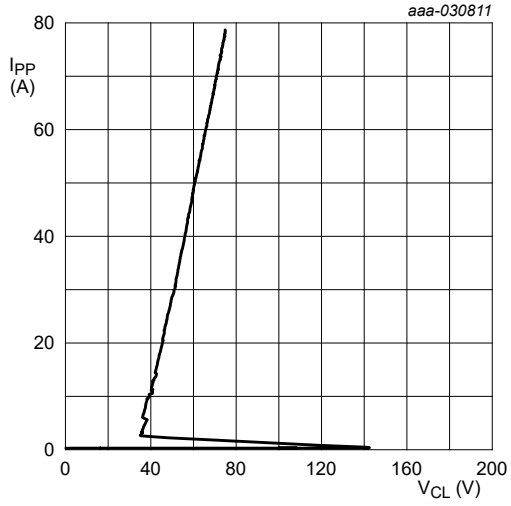
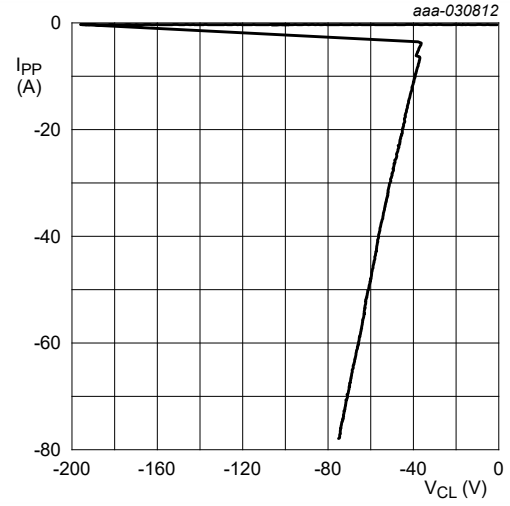

Fig. 4. Relative variation of peak pulse power as a function of junction temperature; typical values



$t_r = 1 \text{ ns}$
 $t_p = 100 \text{ ns}$; Transmission Line Pulse (TLP)

Fig. 5. Dynamic resistance with positive clamping; typical values



$t_r = 1 \text{ ns}$
 $t_p = 100 \text{ ns}$; Transmission Line Pulse (TLP)

Fig. 6. Dynamic resistance with negative clamping; typical values

10. Application information

In the „IEEE 100BASE-T1 EMC Test Specification for ESD suppression devices“¹ document (further referred as OPEN Alliance 100BASE-T1 specification), the OPEN Alliance describes four different tests to ensure compliance of ESD suppressor devices and PHYs which are compliant according to the document “Transceiver EMC Test Specification”. The PESD2ETH1G-T passes all tests as shown on figures 6 to 16. Furthermore, it complies with the requirements mentioned in Section 2.2. of „IEEE 100BASE-T1 EMC Test Specification for ESD suppression devices“.

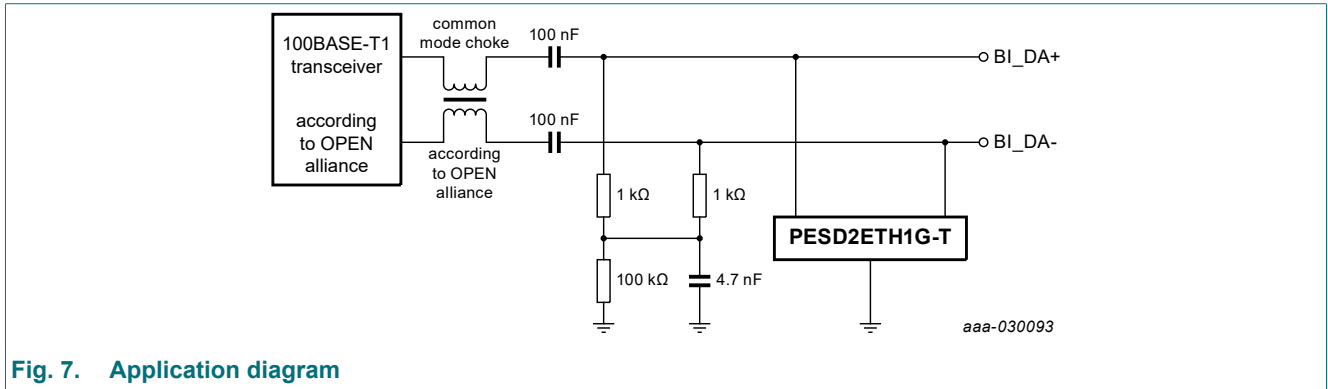

Fig. 7. Application diagram

The return loss and insertion loss are evaluated using the differential S-parameters S_{dd11} and S_{dd21} . These measurements replace the requirement for a certain capacitance value. To ensure symmetry, the differential to common mode rejection is evaluated using the S-parameter S_{sd21} . This measurement replaces the requirement for a matching of the capacitances per line. To ensure that the device does not degrade and changes behavior after repetitive ESD events, the S-parameter measurements are repeated after discharging 20 times ± 8 kV ESD on signal lines 1 and 2, with $C = 150$ pF, $R = 330 \Omega$ according to ISO 10605. Subsequently, the S-parameters are measured again and compared to the original data.

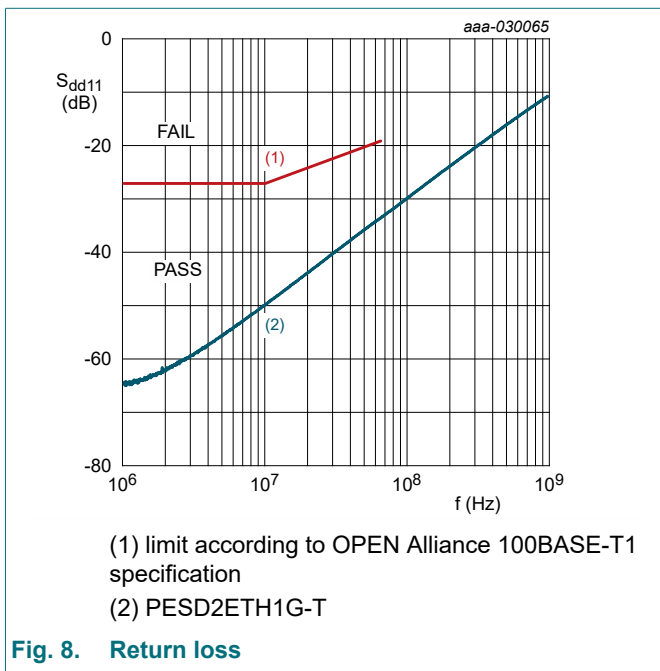

Fig. 8. Return loss

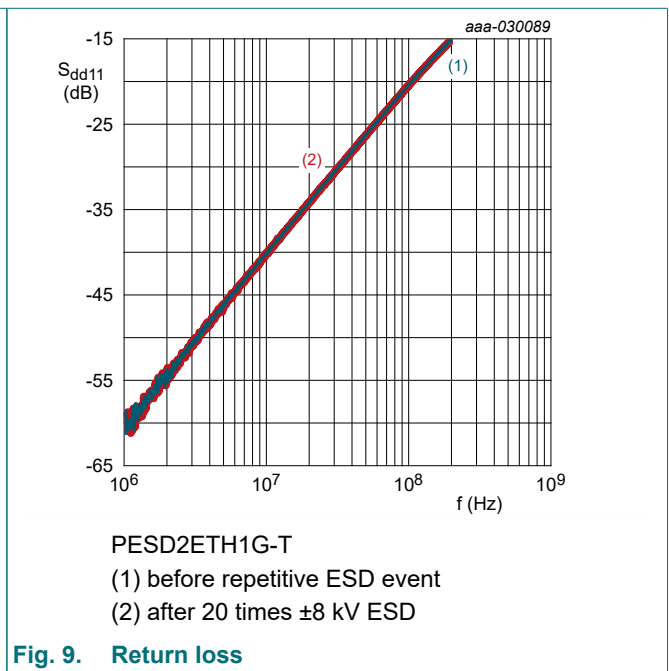

Fig. 9. Return loss

1 OPEN Alliance: “IEEE 100BASE-T1 EMC Test Specification for ESD suppression devices”, version 1.0 rev. draft, December 10, 2018

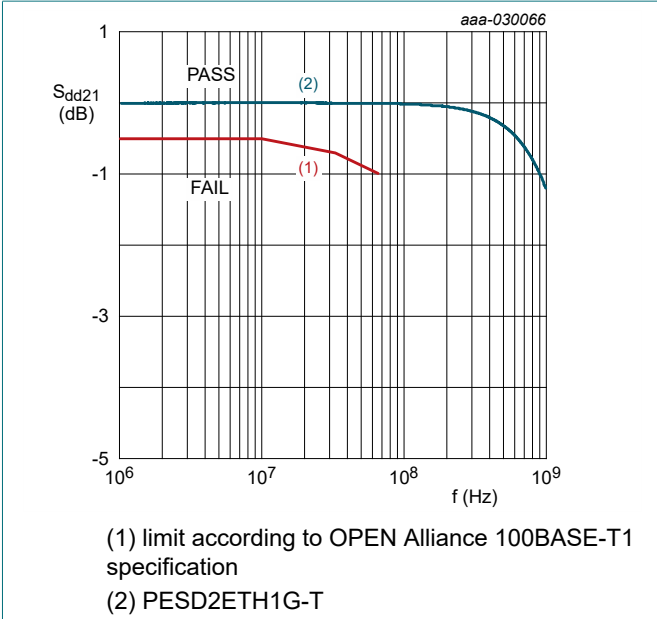

Fig. 10. Insertion loss

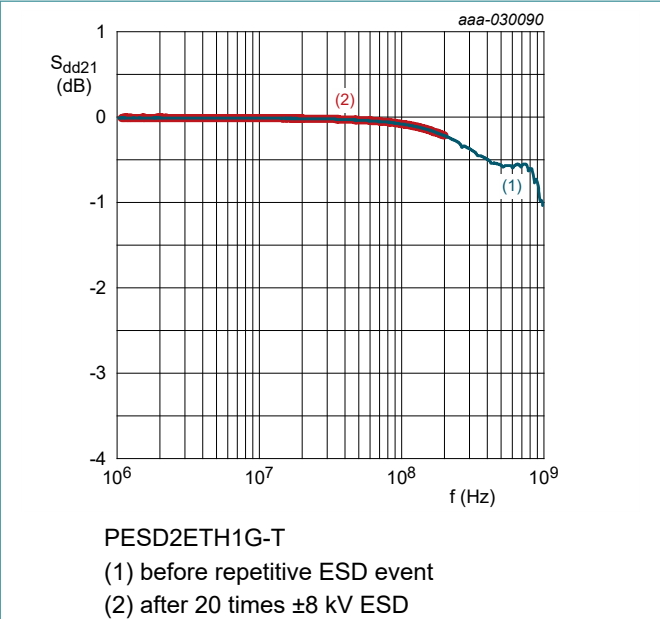

Fig. 11. Insertion loss

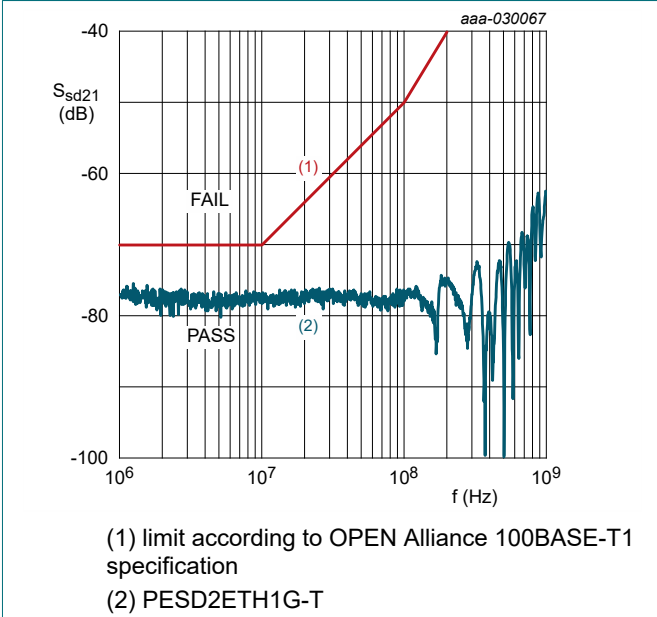

Fig. 12. Differential to common mode rejection

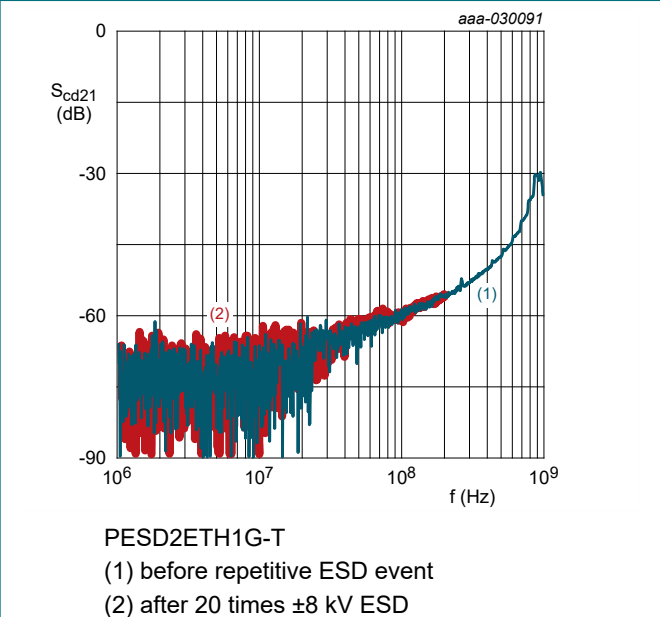

Fig. 13. Differential to common mode rejection

To predict if the ESD suppressor device would protect a PHY of a certain robustness class (Class I (JEDEC-HBM 4 kV) and Class II (JEDEC-HBM 2 kV)), the ESD discharge current is measured in a reference circuit according to OPEN Alliance 100BASE-T1 specification for ± 4 kV and ± 6 kV according to IEC 61000-4-2 with $C = 150$ pF and $R = 330 \Omega$. Unlike in the OPEN Alliance 100BASE-T1 specification of October 29 2017, the „Transceiver Simulation network“ is implemented with 2Ω and 50Ω resistors.

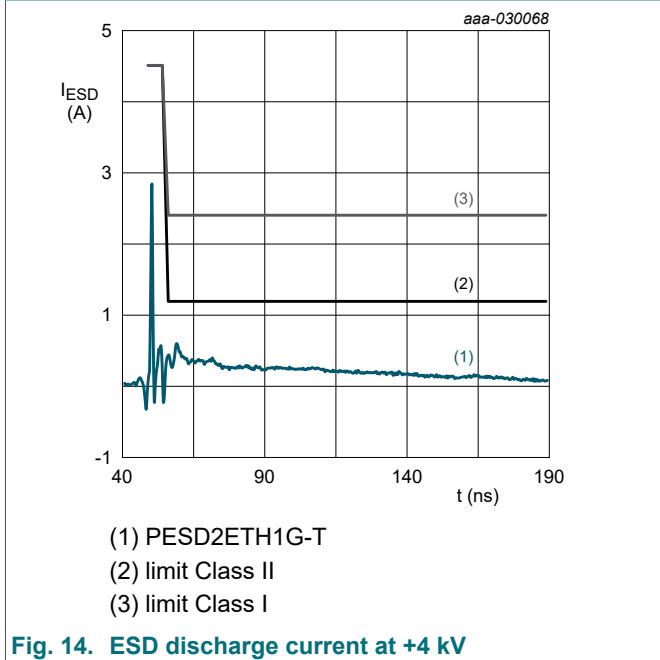

Fig. 14. ESD discharge current at +4 kV

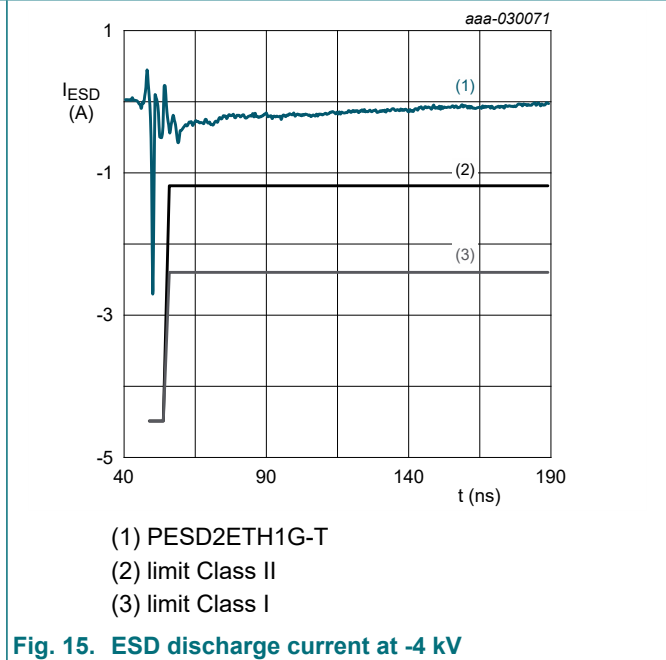

Fig. 15. ESD discharge current at -4 kV

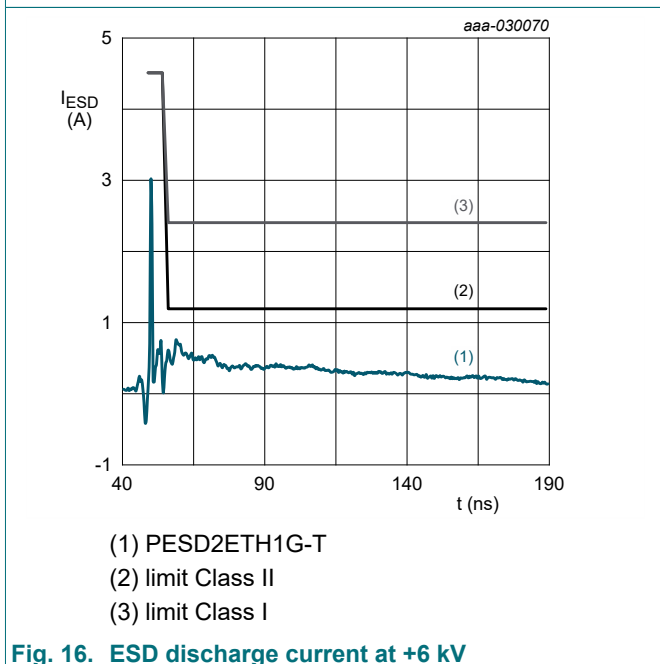

Fig. 16. ESD discharge current at +6 kV

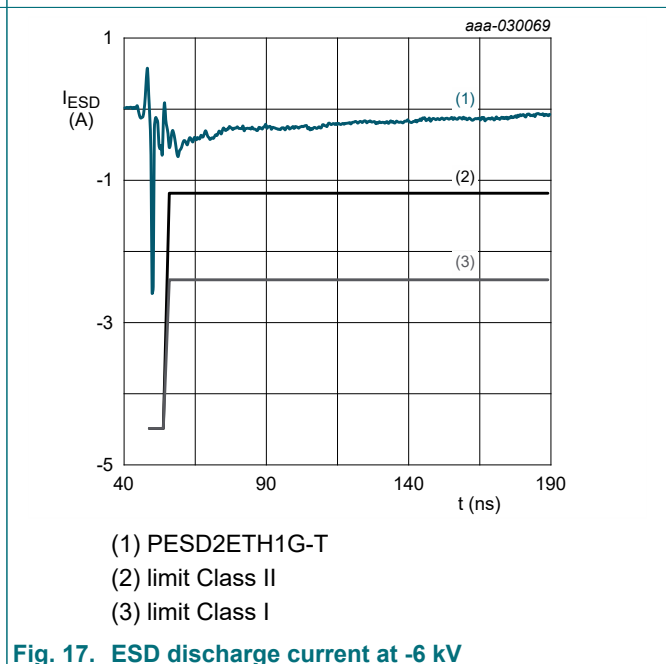
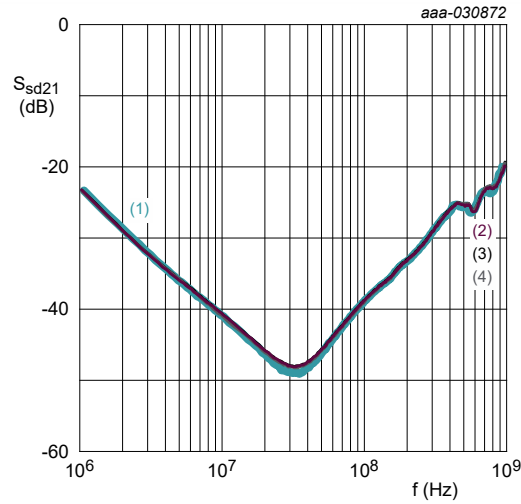

Fig. 17. ESD discharge current at -6 kV

To ensure that the ESD suppressor device is not impacting the EMC performance of the complete module, the RF clamping test as defined in the OPEN Alliance specification is applied. First a measurement at a reference power level of 25 dBm is conducted in an environment defined by the OPEN Alliance 100BASE-T1 specification. Next, the power is increased to 33 dBm (Class I), 36 dBm (Class II), and 39 dBm (Class III). No change in the measured common mode rejection indicates that the ESD suppressor device is not impacting the modules EMC performance.



According to OPEN Alliance 100BASE-T1 specification

Common mode rejection for:

- (1) reference
- (2) Class I
- (3) Class II
- (4) Class III

Fig. 18. RF Clamping Test

For 1000BASE-T1, there is no published document on the requirements for external ESD suppressor devices. However, a similar requirement specification is in preparation at the time the present document is created. To support the conformity of PESD2ETH1G-T with the to-be-published requirement specification of OPEN Alliance for 1000BASE-T1, results of tests adapted from OPEN Alliance specification for 100BASE-T1 are shown. In these tests, limits are adapted to the current state of the art and the common-mode choke is selected in compliance with the published OPEN Alliance document “IEEE 1000BASE-T1 EMC Test Specification for Common Mode Chokes Version 1.0” as of January 16, 2018.

The following graphs show the S-parameters with adapted limit lines. ESD damage test results of 100BASE-T1 are also valid for 1000BASE-T1.

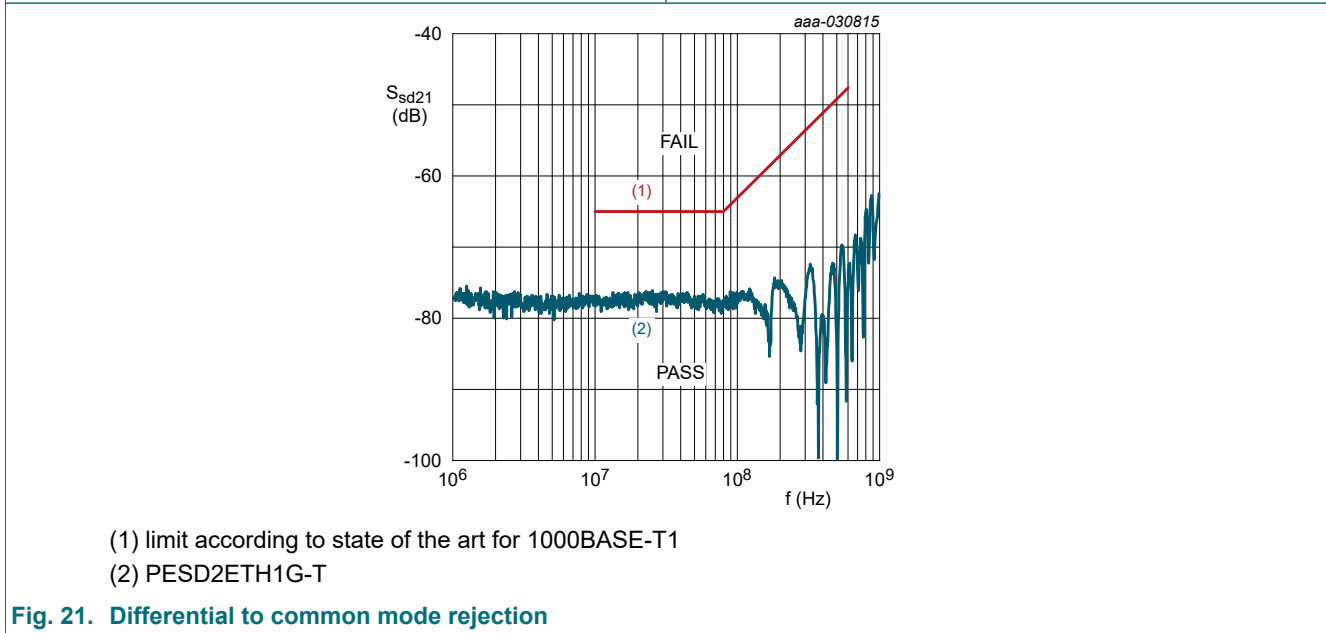
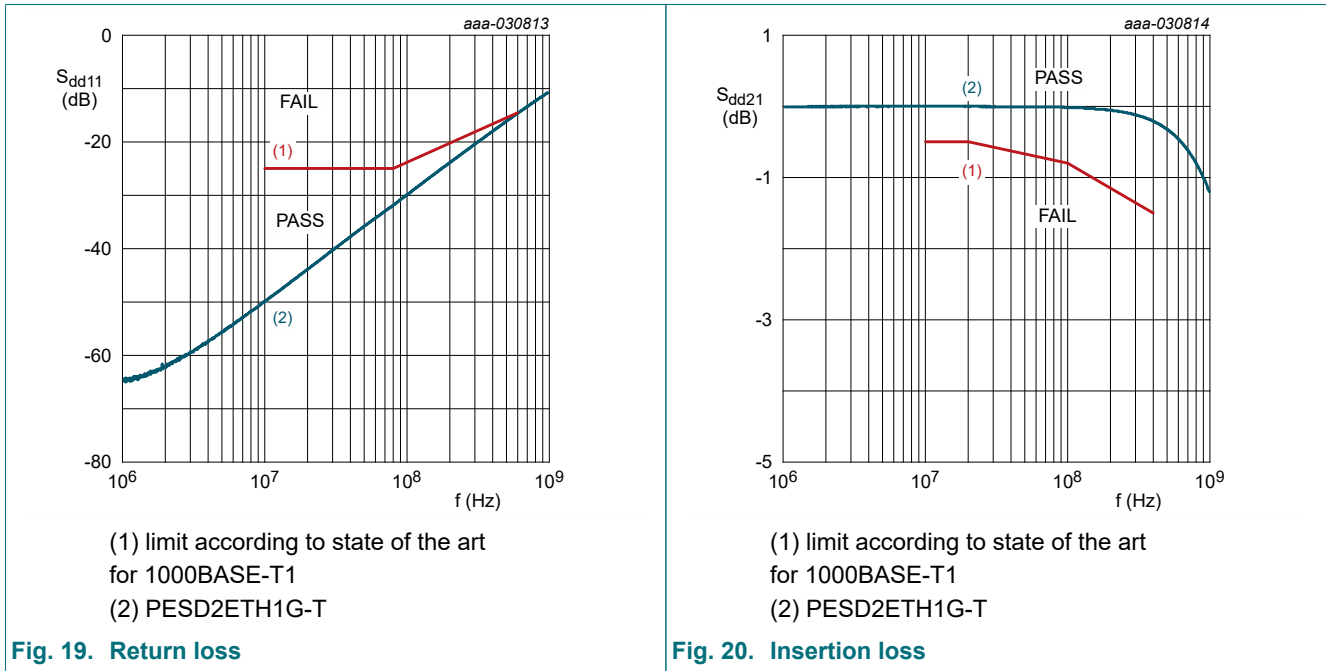

The following graphs show the discharge current measurements, with a 1000BASE-T1 compliant common-mode choke.

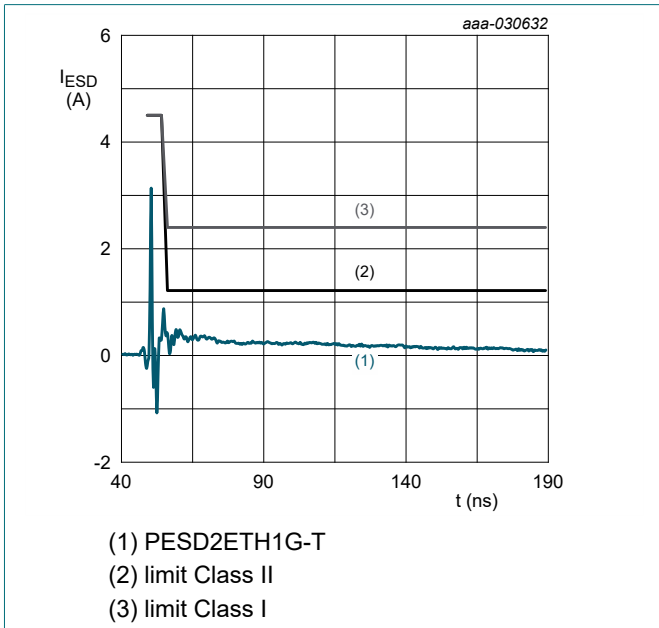

Fig. 22. ESD discharge current at +4 kV

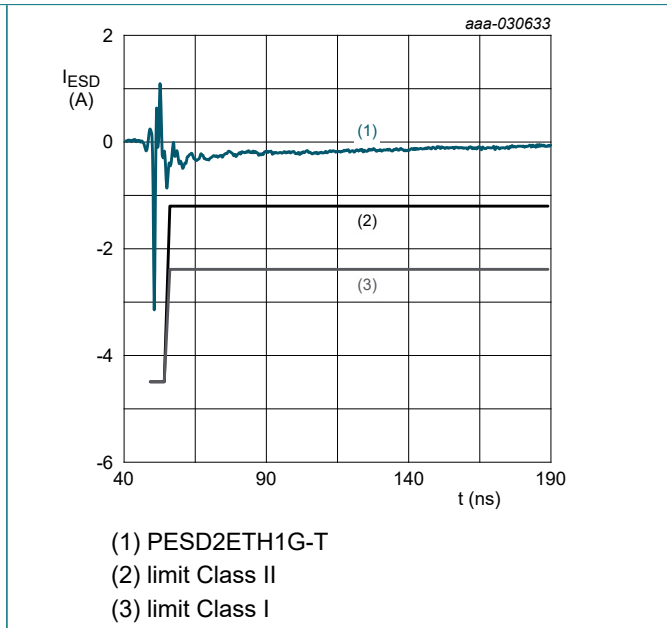

Fig. 23. ESD discharge current at -4 kV

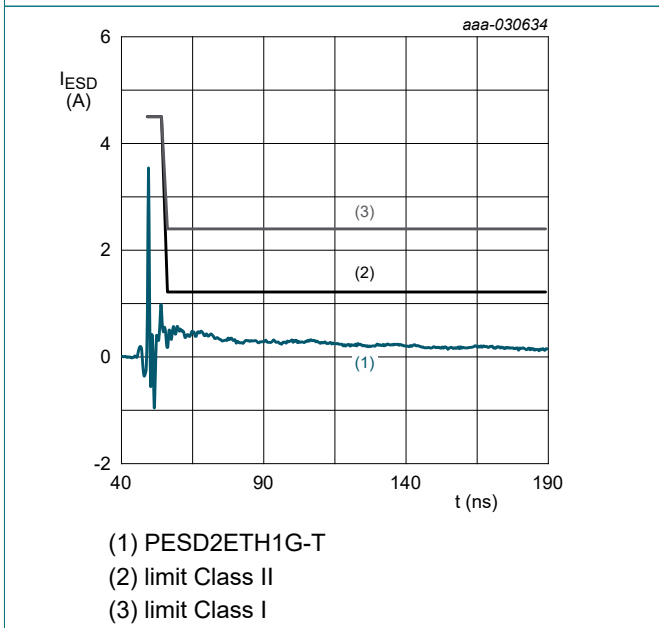

Fig. 24. ESD discharge current at +6 kV

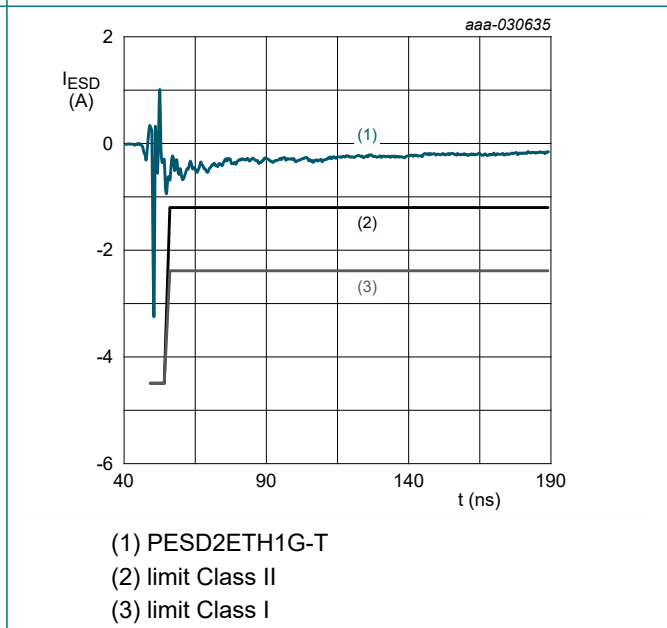
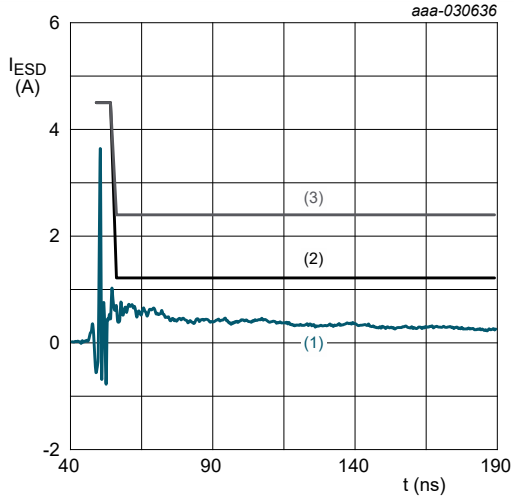
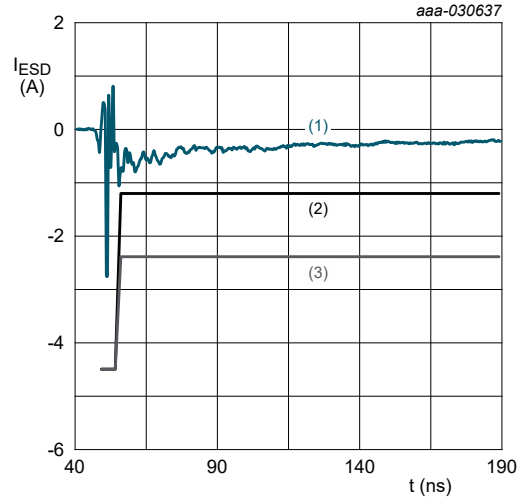

Fig. 25. ESD discharge current at -6 kV



- (1) PESD2ETH1G-T
- (2) limit Class II
- (3) limit Class I

Fig. 26. ESD discharge current at +8 kV



- (1) PESD2ETH1G-T
- (2) limit Class II
- (3) limit Class I

Fig. 27. ESD discharge current at -8 kV

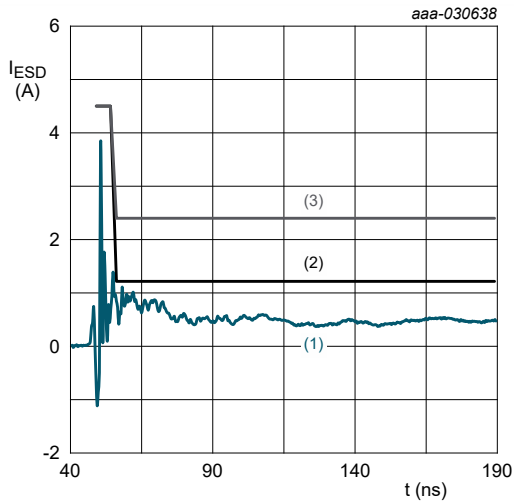

- (1) PESD2ETH1G-T
- (2) limit Class II
- (3) limit Class I

Fig. 28. ESD discharge current at +15 kV

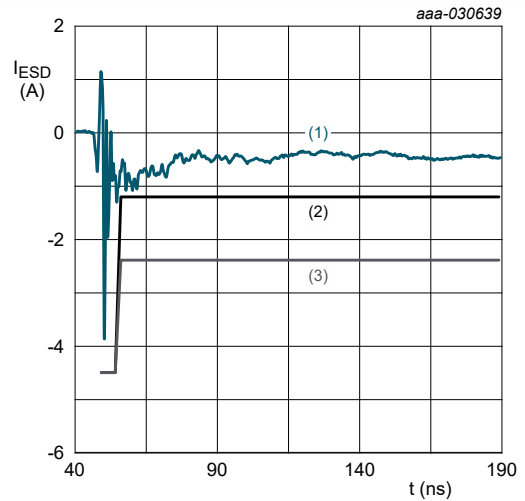

- (1) PESD2ETH1G-T
- (2) limit Class II
- (3) limit Class I

Fig. 29. ESD discharge current at -15 kV

The following graph shows the RF clamping test with a 1000BASE-T1 compliant common-mode choke.

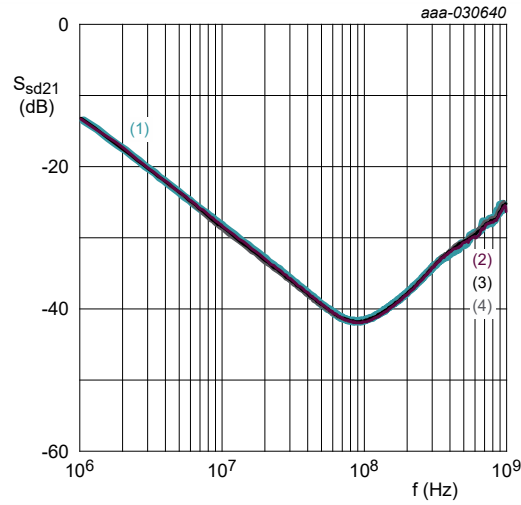

According to state of the art for 1000BASE-T1

Common mode rejection for:

- (1) reference
- (2) Class I
- (3) Class II
- (4) Class III

Fig. 30. RF Clamping Test

11. Package outline

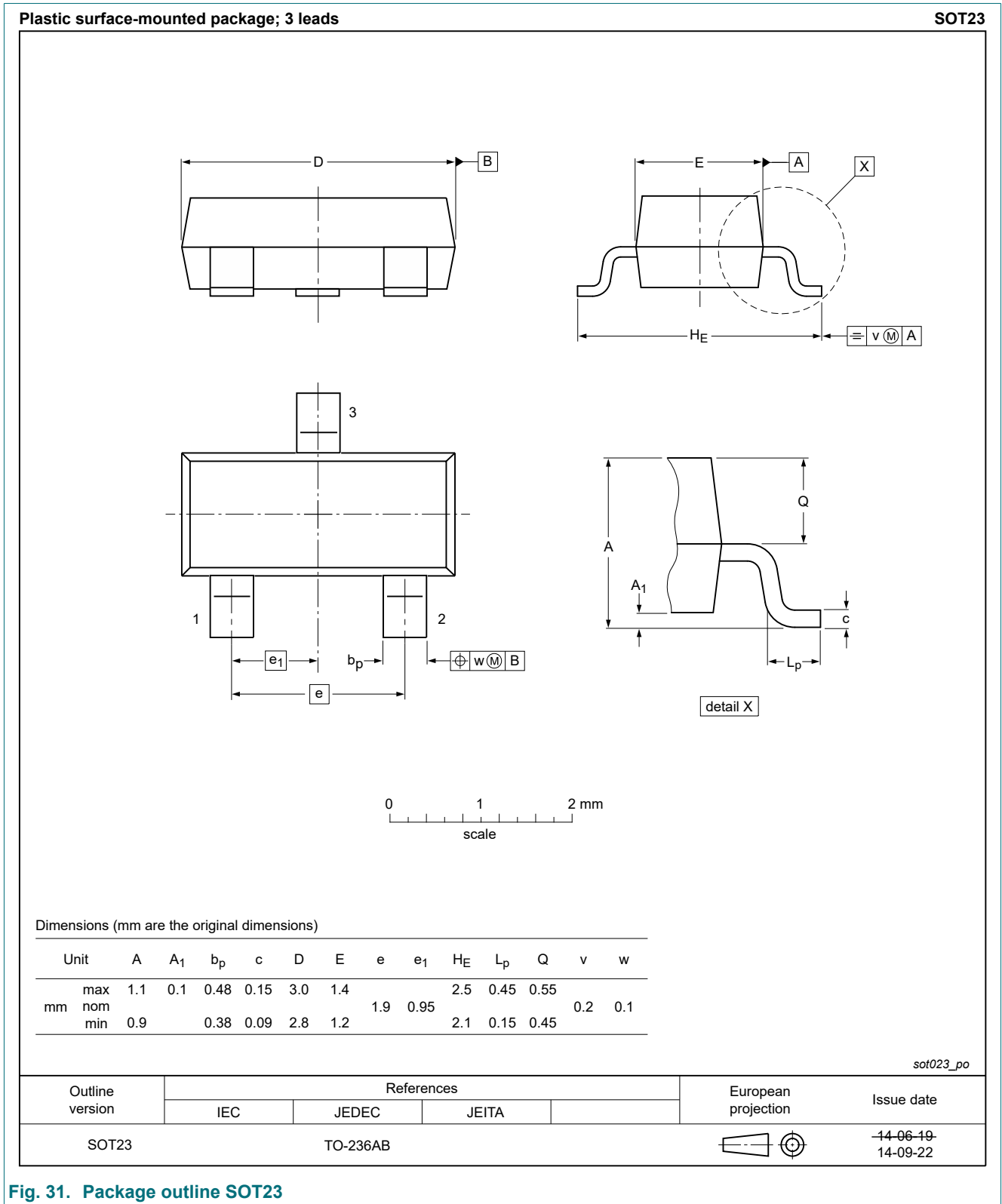

Fig. 31. Package outline SOT23

12. Soldering

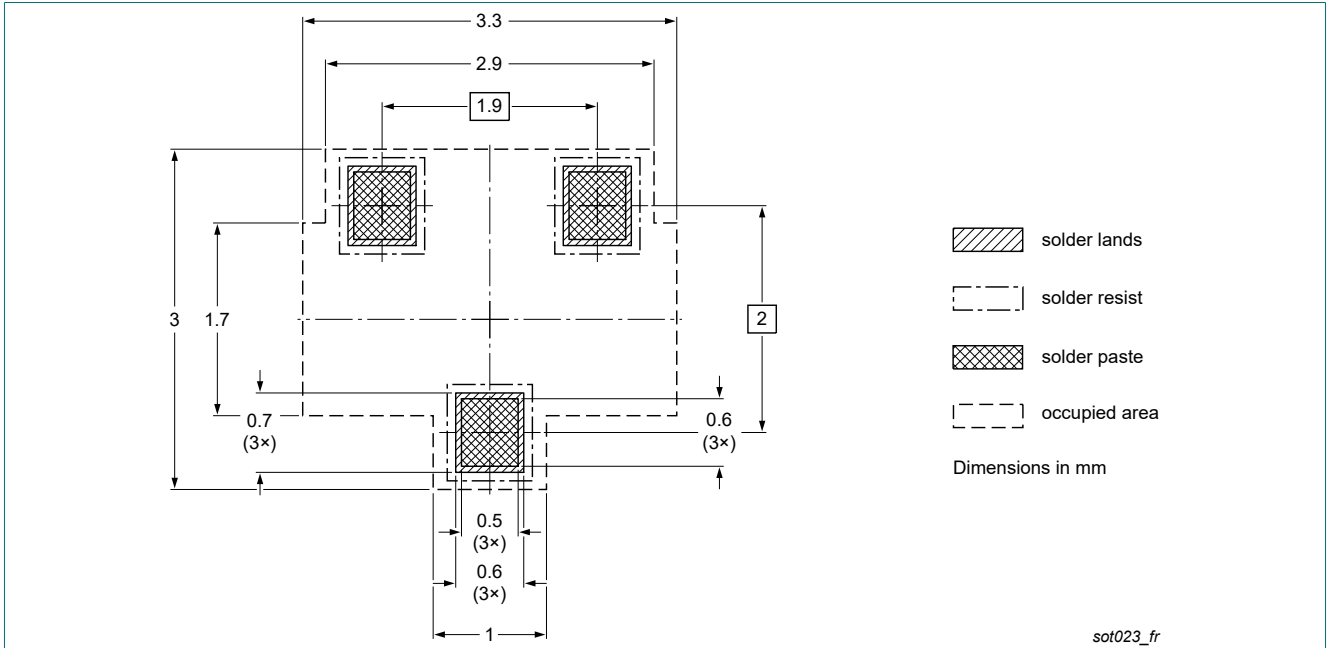

Fig. 32. Reflow soldering footprint for SOT23

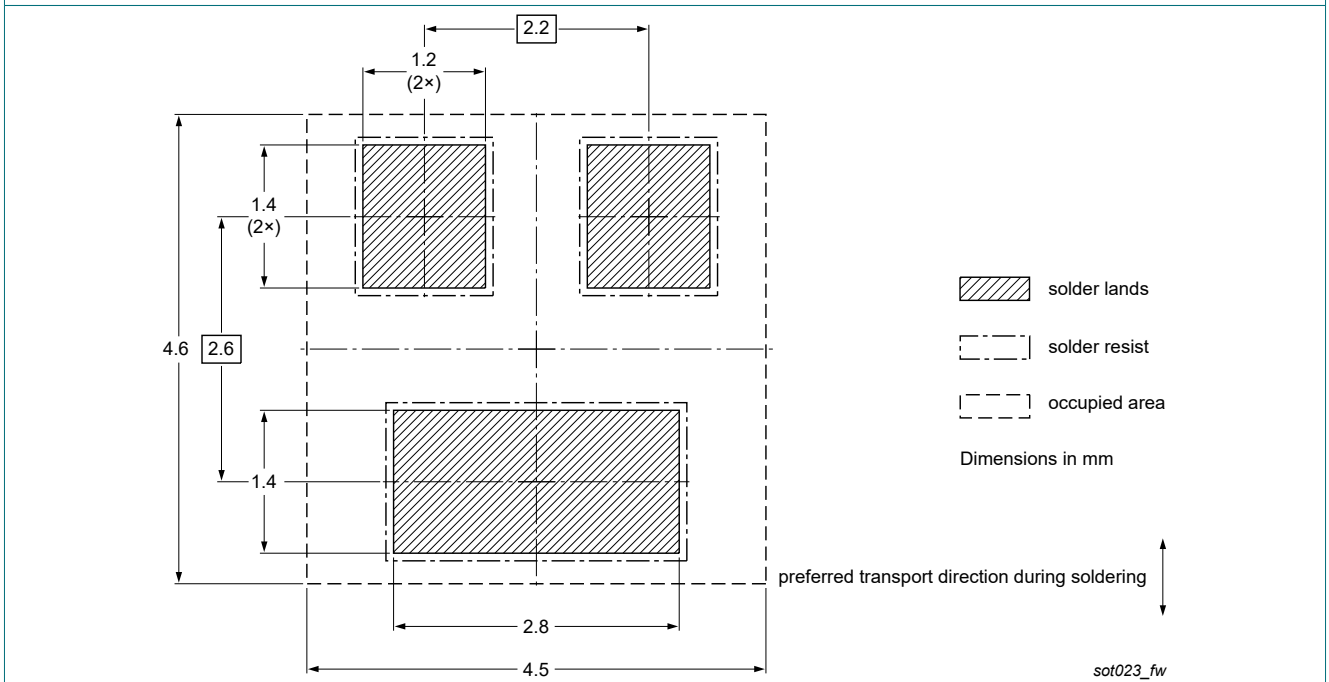

Fig. 33. Wave soldering footprint for SOT23

13. Revision history

Table 7. Revision history

Data sheet ID	Release date	Data sheet status	Change notice	Supersedes
PESD2ETH1G-T v.2	20200207	Product data sheet	-	PESD2ETH1G-T v.1
Modifications;	<ul style="list-style-type: none"> • Sections "General description", "Features and benefits", and "Applications": updated • Table "Quick reference data": updated • Table "Limiting values": enhanced V_{ESD} • Section "Characteristics": updated • Section "Application information": updated 			
PESD2ETH1G-T v.1	20190708	Objective data sheet	-	-

14. Legal information

Data sheet status

Document status [1][2]	Product status [3]	Definition
Objective [short] data sheet	Development	This document contains data from the objective specification for product development.
Preliminary [short] data sheet	Qualification	This document contains data from the preliminary specification.
Product [short] data sheet	Production	This document contains the product specification.

- [1] Please consult the most recently issued document before initiating or completing a design.
- [2] The term 'short data sheet' is explained in section "Definitions".
- [3] The product status of device(s) described in this document may have changed since this document was published and may differ in case of multiple devices. The latest product status information is available on the internet at <https://www.nexperia.com>.

Definitions

Draft — The document is a draft version only. The content is still under internal review and subject to formal approval, which may result in modifications or additions. Nexperia does not give any representations or warranties as to the accuracy or completeness of information included herein and shall have no liability for the consequences of use of such information.

Short data sheet — A short data sheet is an extract from a full data sheet with the same product type number(s) and title. A short data sheet is intended for quick reference only and should not be relied upon to contain detailed and full information. For detailed and full information see the relevant full data sheet, which is available on request via the local Nexperia sales office. In case of any inconsistency or conflict with the short data sheet, the full data sheet shall prevail.

Product specification — The information and data provided in a Product data sheet shall define the specification of the product as agreed between Nexperia and its customer, unless Nexperia and customer have explicitly agreed otherwise in writing. In no event however, shall an agreement be valid in which the Nexperia product is deemed to offer functions and qualities beyond those described in the Product data sheet.

Disclaimers

Limited warranty and liability — Information in this document is believed to be accurate and reliable. However, Nexperia does not give any representations or warranties, expressed or implied, as to the accuracy or completeness of such information and shall have no liability for the consequences of use of such information. Nexperia takes no responsibility for the content in this document if provided by an information source outside of Nexperia.

In no event shall Nexperia be liable for any indirect, incidental, punitive, special or consequential damages (including - without limitation - lost profits, lost savings, business interruption, costs related to the removal or replacement of any products or rework charges) whether or not such damages are based on tort (including negligence), warranty, breach of contract or any other legal theory.

Notwithstanding any damages that customer might incur for any reason whatsoever, Nexperia's aggregate and cumulative liability towards customer for the products described herein shall be limited in accordance with the Terms and conditions of commercial sale of Nexperia.

Right to make changes — Nexperia reserves the right to make changes to information published in this document, including without limitation specifications and product descriptions, at any time and without notice. This document supersedes and replaces all information supplied prior to the publication hereof.

Suitability for use in automotive applications — This Nexperia product has been qualified for use in automotive applications. Unless otherwise agreed in writing, the product is not designed, authorized or warranted to be suitable for use in life support, life-critical or safety-critical systems or

equipment, nor in applications where failure or malfunction of an Nexperia product can reasonably be expected to result in personal injury, death or severe property or environmental damage. Nexperia and its suppliers accept no liability for inclusion and/or use of Nexperia products in such equipment or applications and therefore such inclusion and/or use is at the customer's own risk.

Quick reference data — The Quick reference data is an extract of the product data given in the Limiting values and Characteristics sections of this document, and as such is not complete, exhaustive or legally binding.

Applications — Applications that are described herein for any of these products are for illustrative purposes only. Nexperia makes no representation or warranty that such applications will be suitable for the specified use without further testing or modification.

Customers are responsible for the design and operation of their applications and products using Nexperia products, and Nexperia accepts no liability for any assistance with applications or customer product design. It is customer's sole responsibility to determine whether the Nexperia product is suitable and fit for the customer's applications and products planned, as well as for the planned application and use of customer's third party customer(s). Customers should provide appropriate design and operating safeguards to minimize the risks associated with their applications and products.

Nexperia does not accept any liability related to any default, damage, costs or problem which is based on any weakness or default in the customer's applications or products, or the application or use by customer's third party customer(s). Customer is responsible for doing all necessary testing for the customer's applications and products using Nexperia products in order to avoid a default of the applications and the products or of the application or use by customer's third party customer(s). Nexperia does not accept any liability in this respect.

Limiting values — Stress above one or more limiting values (as defined in the Absolute Maximum Ratings System of IEC 60134) will cause permanent damage to the device. Limiting values are stress ratings only and (proper) operation of the device at these or any other conditions above those given in the Recommended operating conditions section (if present) or the Characteristics sections of this document is not warranted. Constant or repeated exposure to limiting values will permanently and irreversibly affect the quality and reliability of the device.

Terms and conditions of commercial sale — Nexperia products are sold subject to the general terms and conditions of commercial sale, as published at <http://www.nexperia.com/profile/terms>, unless otherwise agreed in a valid written individual agreement. In case an individual agreement is concluded only the terms and conditions of the respective agreement shall apply. Nexperia hereby expressly objects to applying the customer's general terms and conditions with regard to the purchase of Nexperia products by customer.

No offer to sell or license — Nothing in this document may be interpreted or construed as an offer to sell products that is open for acceptance or the grant, conveyance or implication of any license under any copyrights, patents or other industrial or intellectual property rights.

Export control — This document as well as the item(s) described herein may be subject to export control regulations. Export might require a prior authorization from competent authorities.

Translations — A non-English (translated) version of a document is for reference only. The English version shall prevail in case of any discrepancy between the translated and English versions.

Trademarks

Notice: All referenced brands, product names, service names and trademarks are the property of their respective owners.

Contents

1. General description.....	1
2. Features and benefits.....	1
3. Applications.....	1
4. Quick reference data.....	1
5. Pinning information.....	2
6. Ordering information.....	2
7. Marking.....	2
8. Limiting values.....	3
9. Characteristics.....	4
10. Application information.....	6
11. Package outline.....	14
12. Soldering.....	15
13. Revision history.....	16
14. Legal information.....	17

© Nexperia B.V. 2020. All rights reserved

For more information, please visit: <http://www.nexperia.com>

For sales office addresses, please send an email to: salesaddresses@nexperia.com

Date of release: 7 February 2020
