

# RFSA3613

## 5MHz to 6000MHz, Digital Step Attenuator

The RFMD's RFSA3613 is a 6-bit digital step attenuator (DSA) that features high linearity over the entire 31.5dB gain control range with 0.5dB steps. The RFSA3613 uses serial control interface. The RFSA3613 has a low insertion loss of 1.4dB at 2GHz. Patent pending circuit architecture provides overshoot-free transient switching performance. External address pins allow up to eight DSAs to be controlled on a single bus. The RFSA3613 is available in a 3mm x 3mm QFN package.



Package: QFN, 16-pin,  
3.0mm x 3.0mm x 0.85mm

### Features

- 6-Bit, 31.5dB Range, 0.5dB Step
- Patent Pending Circuit Architecture
- Overshoot-free Transient Switching Performance
- Frequency Range 5MHz to 6000MHz
- High Linearity, IIP3 >55dBm
- Serial Control Interface
- Fast Switching Speed, <120nsec Typical
- Serial Addressable Supports Up to Eight Addresses
- Single Supply 3V to 5V Operation
- RF Pins Have No DC Voltage, Can be DC Grounded Externally
- Power-up Default Setting Is Maximum Attenuation

### Applications

- 2G through 4G Base Stations
- Point-to-Point
- WiFi
- Test Equipment

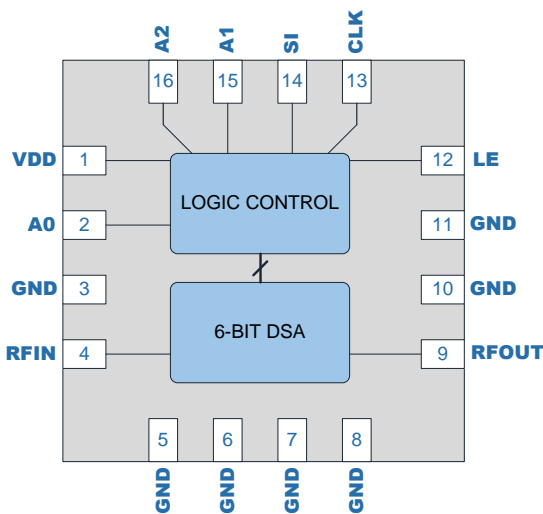

Functional Block Diagram

### Ordering Information

RFSA3613SQ	Sample bag with 25 pieces
RFSA3613SR	7" Reel with 100 pieces
RFSA3613TR7	7" Reel with 2500 pieces
RFSA3613PCK-410	5MHz to 6000MHz PCBA with 5-piece sample bag

## Absolute Maximum Ratings

Parameter	Rating	Unit
Supply Voltage (V <sub>DD</sub> )	-0.5 to +6.0	V
All Other DC and Logic Pins (Supply Voltage Must Be Applied Prior to Any Other Pin Voltages)	-0.5 to V <sub>DD</sub>	V
Maximum Input Power at RFIN Pin at 85°C Case Temperature	+30	dBm
Maximum Input Power at RFOUT Pin at 85°C Case Temperature	+27	dBm
Storage Temperature Range	-40 to +150	°C
ESD Rating - Human Body Model (HBM)	1000	V
Moisture Sensitivity Level	MSL1	



**Caution!** ESD sensitive device.



RFMD Green: RoHS status based on EU Directive 2011/65/EU (at time of this document revision), halogen free per IEC 61249-2-21, < 1000ppm each of antimony trioxide in polymeric materials and red phosphorus as a flame retardant, and <2% antimony in solder.

Exceeding any one or a combination of the Absolute Maximum Rating conditions may cause permanent damage to the device. Extended application of Absolute Maximum Rating conditions to the device may reduce device reliability. Specified typical performance or functional operation of the device under Absolute Maximum Rating conditions is not implied.

## Recommended Operating Condition

Parameter	Specification			Unit
	Min	Typ	Max	
Operating Temperature Range (RF Input Power Handling Derates Above 85°C)	-40		+105	°C
Operating Junction Temperature			125	°C
Supply Voltage	2.7		5.5	V

## Nominal Operating Parameters

Parameter	Specification			Unit	Condition
	Min	Typ	Max		
<b>General Performance</b>					
Supply Current		180		μA	Steady state operation, current draw during attenuation state transitions is higher.
Thermal Resistance		55		°C/W	At maximum attenuation state with RF power applied to the RFIN pin
RF Input Power at RFIN Pin			27	dBm	Continuous operation at +85°C case temperature
RF Input Power at RFOUT Pin			20	dBm	
<b>RF Performance</b>					
Frequency Range	5		6000	MHz	
Insertion Loss		1.4		dB	2000MHz, 0dB attenuation
Attenuation Range		31.5		dB	0.5dB step size
Absolute Attenuation Error	±(0.2 + 4%)			dB	2000MHz
Input IP3		55		dBm	
Input P0.1dB		30		dBm	
Return Loss		15		dB	
Input and Output Impedance		50		Ω	

Parameter	Specification			Unit	Condition
	Min	Typ	Max		
<b>General Performance</b>					
Switching Speed		120		nsec	50% control to 10%/90% RF
Successive Step Phase Delta		2		Deg	2000MHz
<b>Control</b>					
Digital Logic Low			0.63	V	
Digital Logic High	1.17			V	

Note: Typical performance at these conditions: Temp = +25°C, 2000MHz, 5V Supply Voltage

Typical Application Schematic

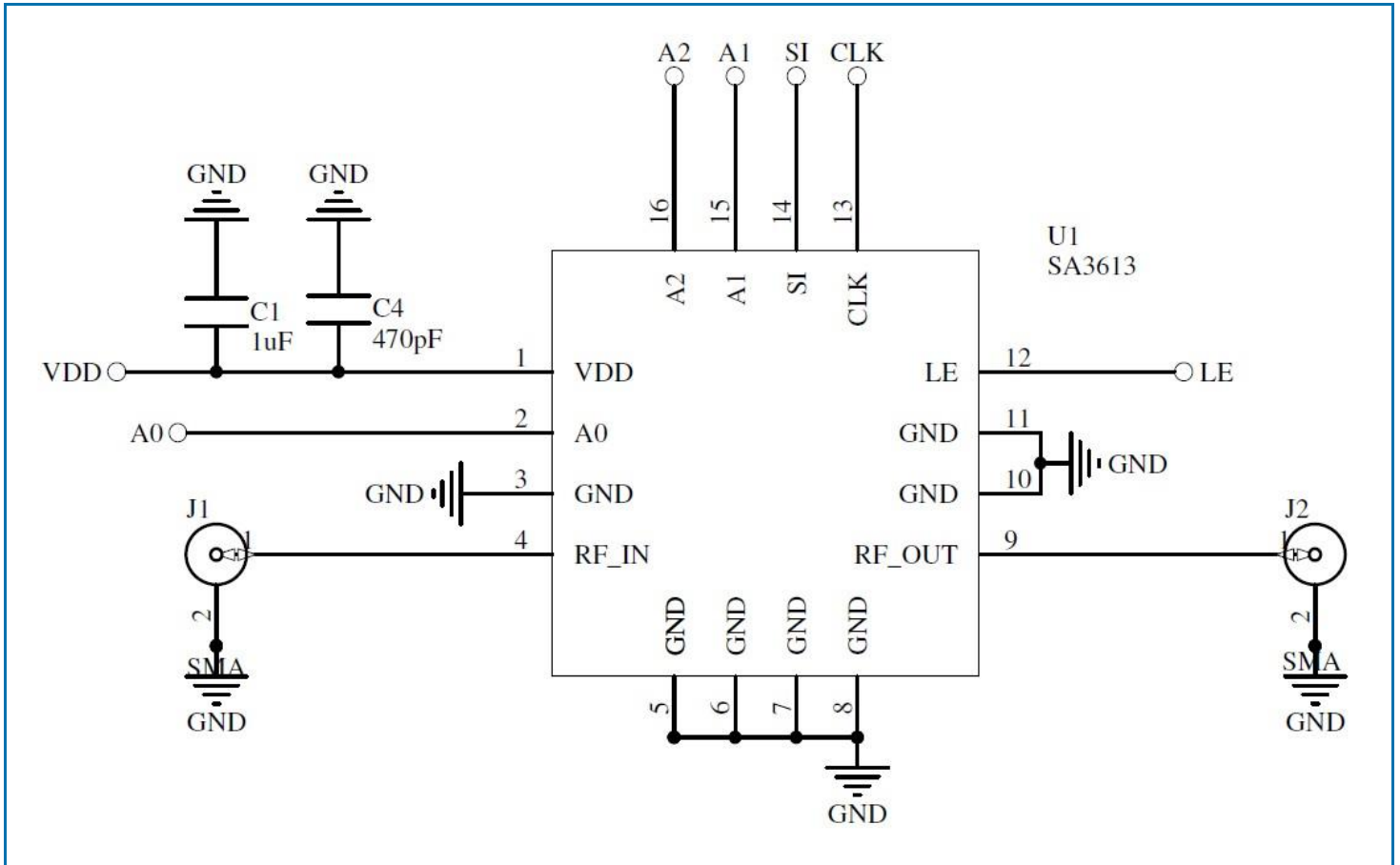

Typical Performance:

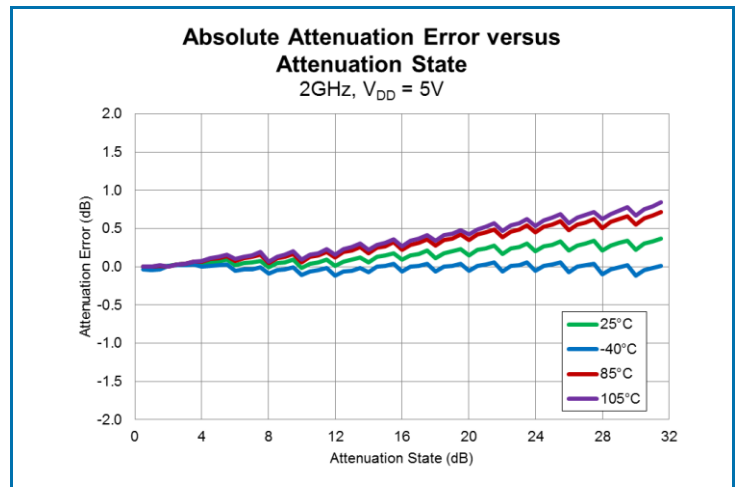
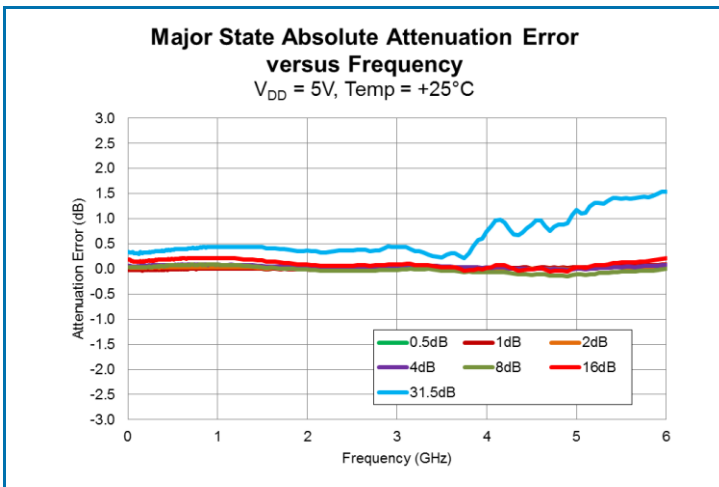
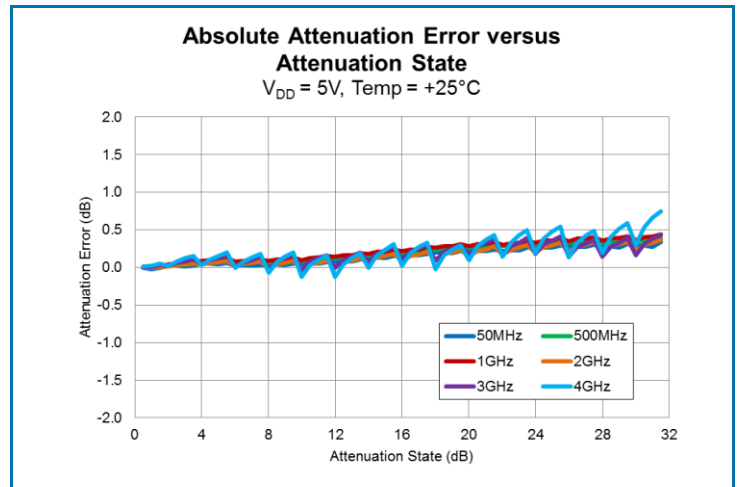
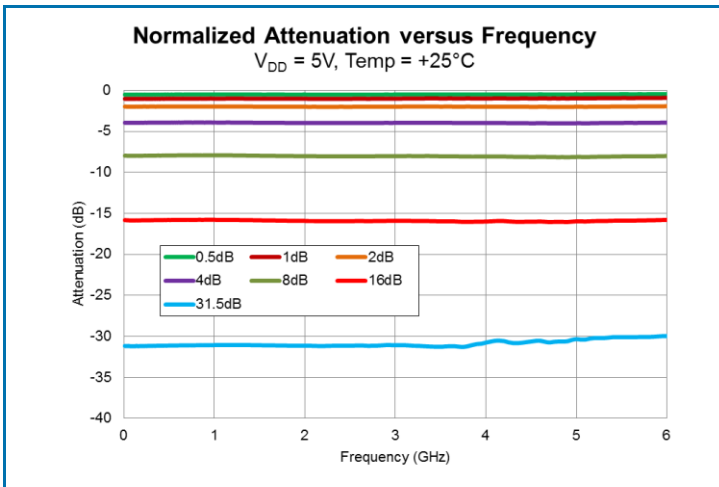
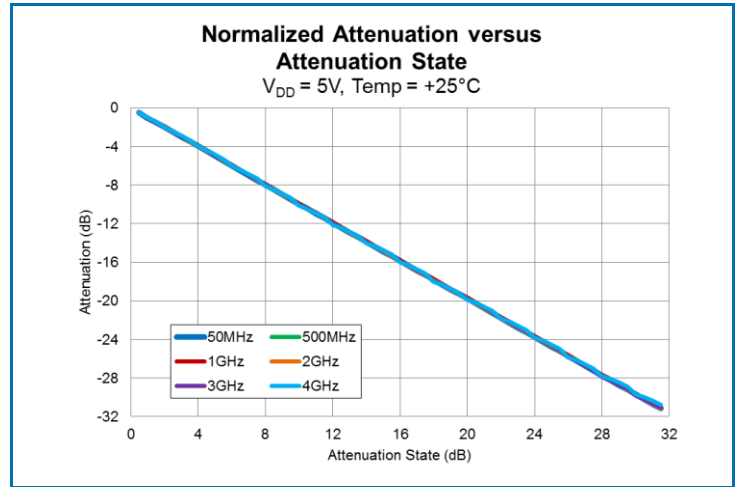
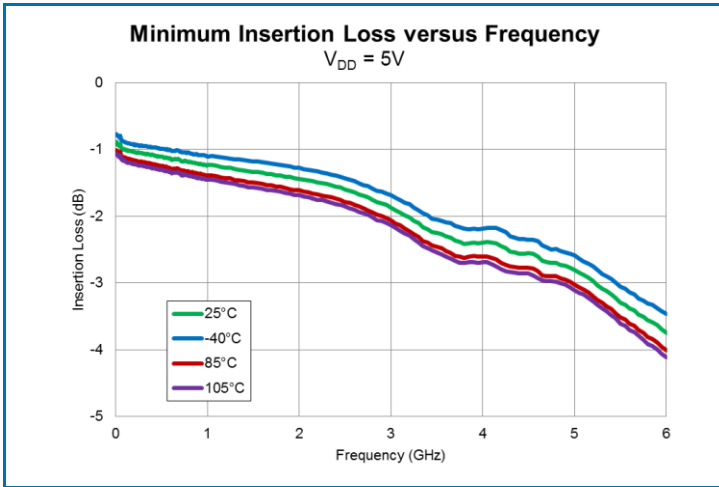

Typical Performance:

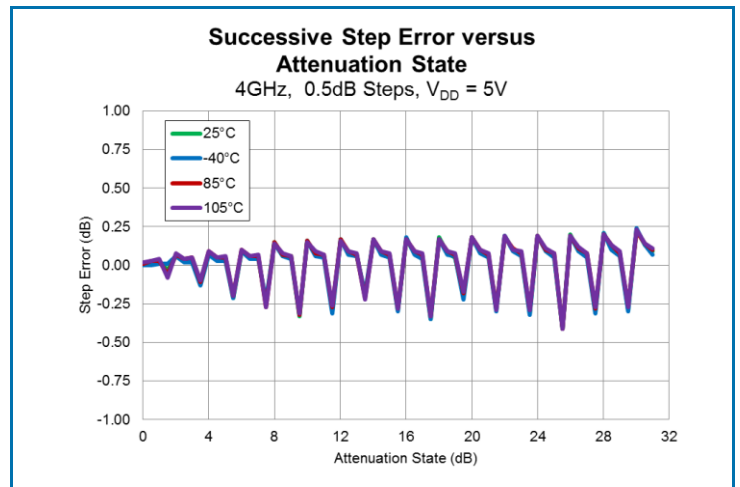
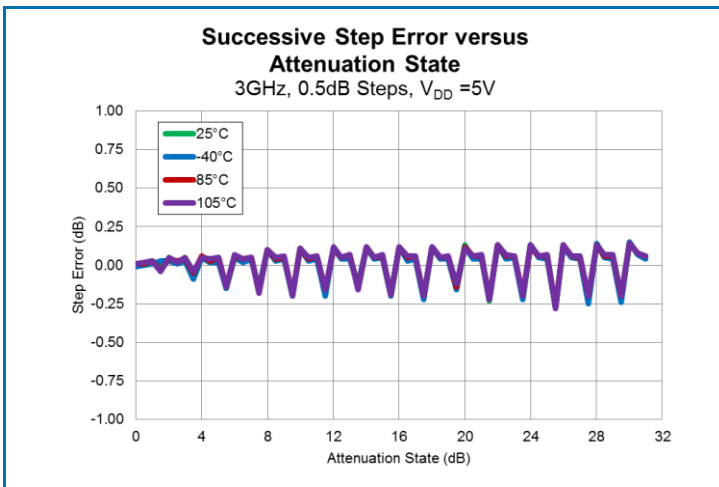
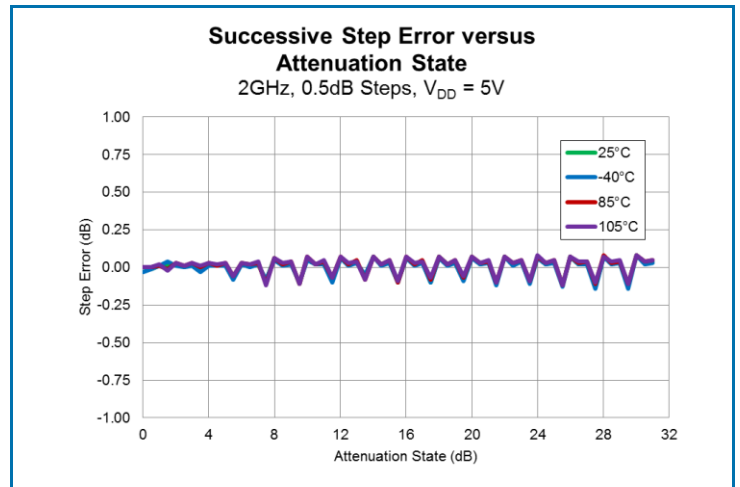
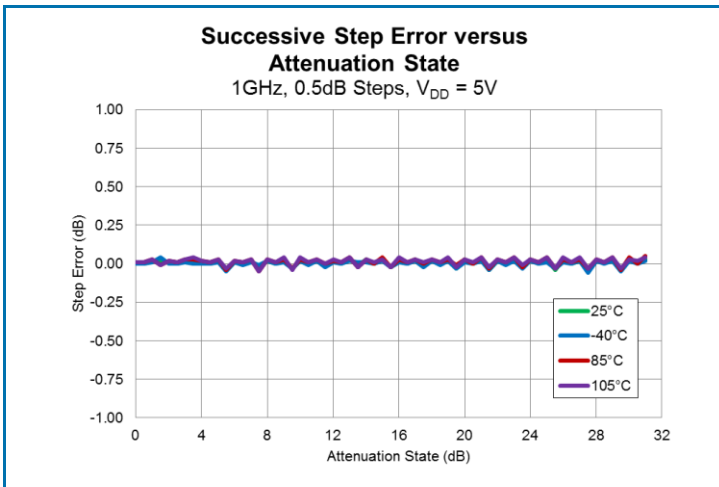
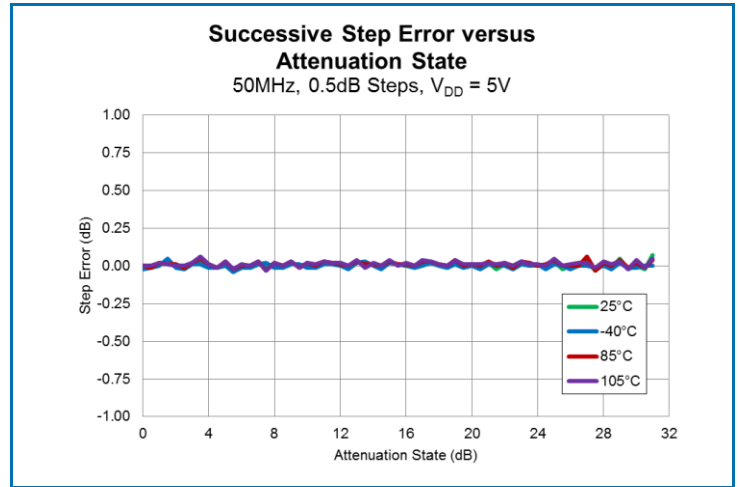
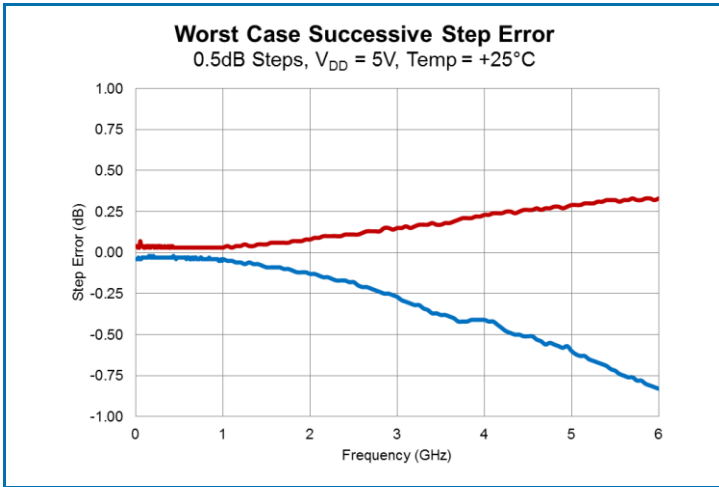

Note: Attenuator remains monotonic if step error is less than +0.5dB.

Typical Performance:

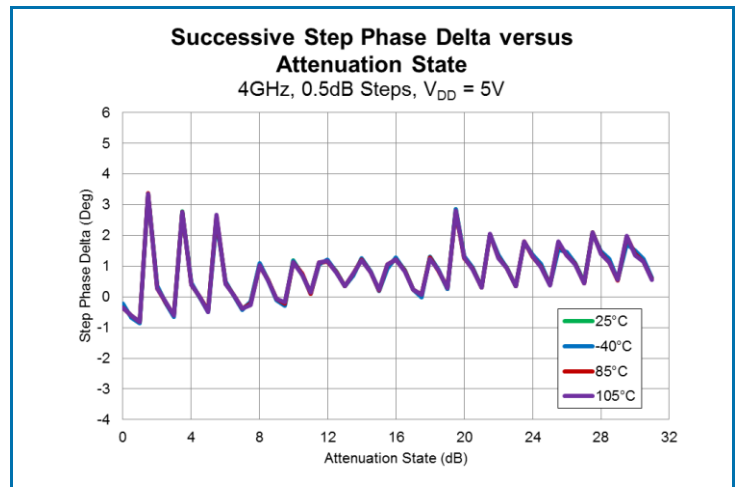
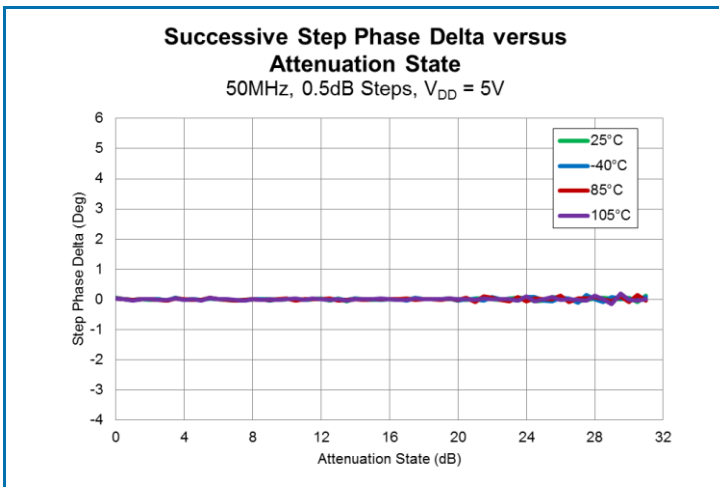
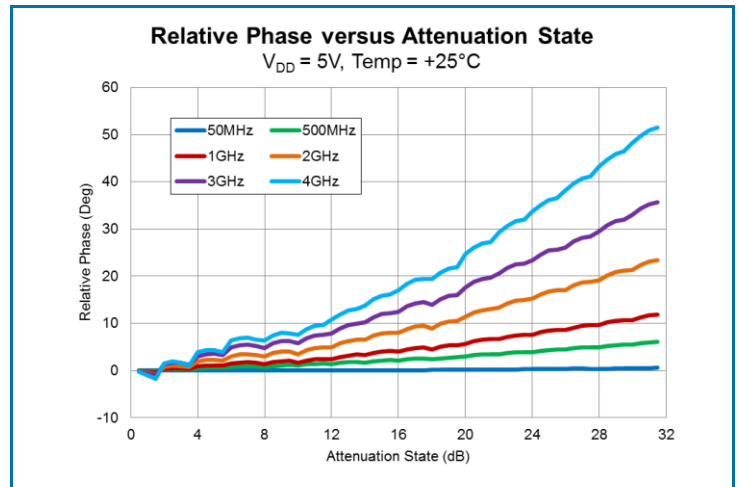
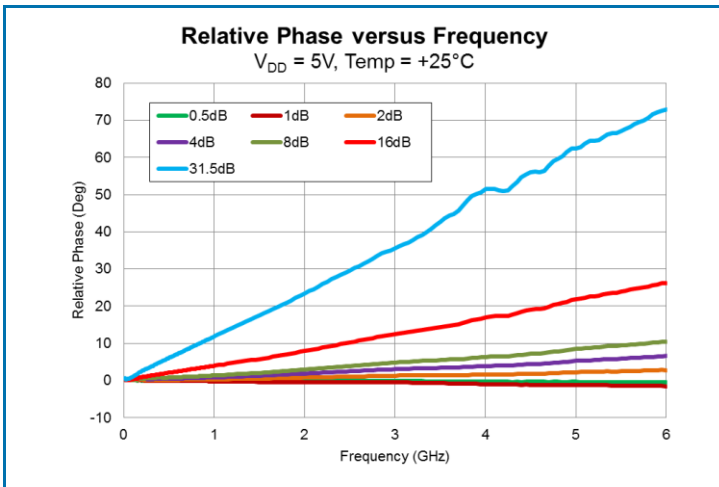
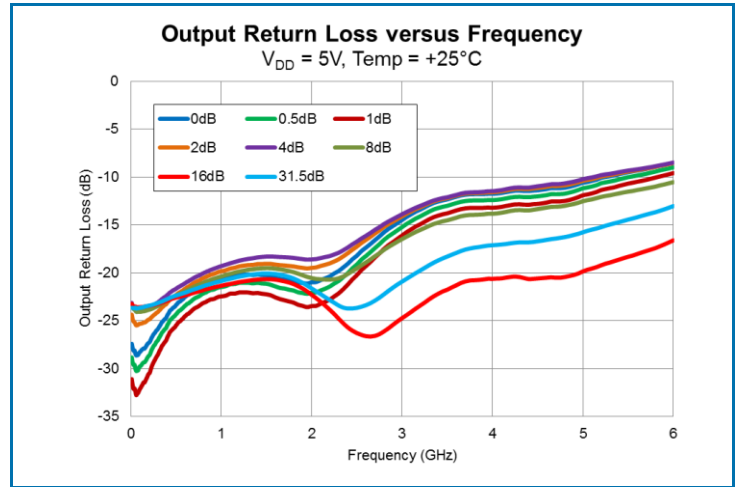
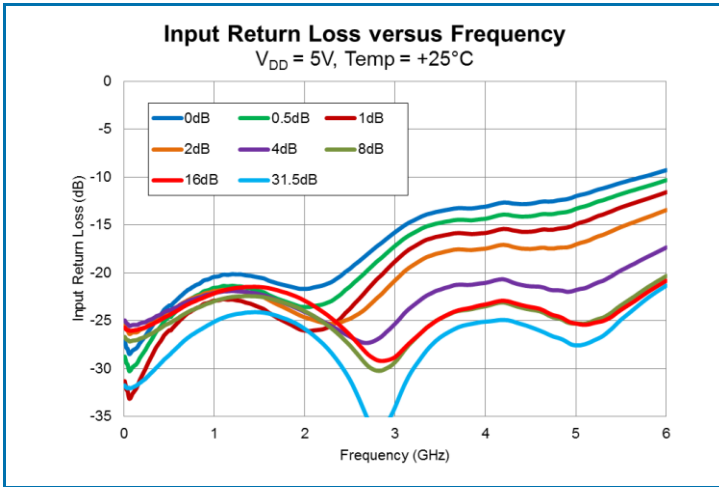

Typical Performance:

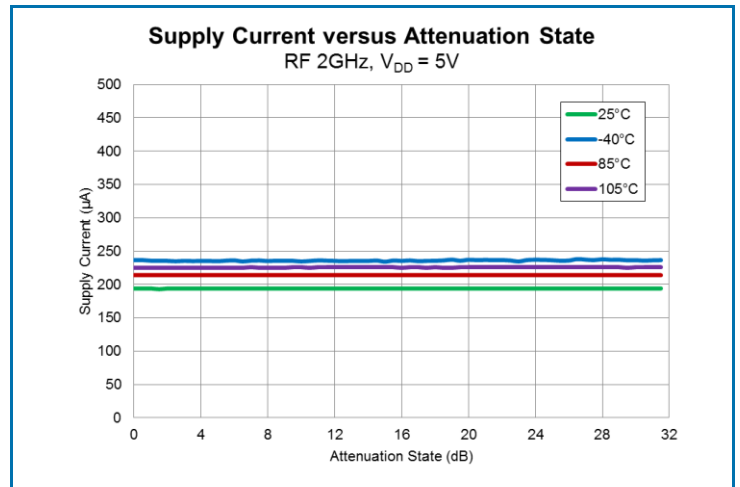
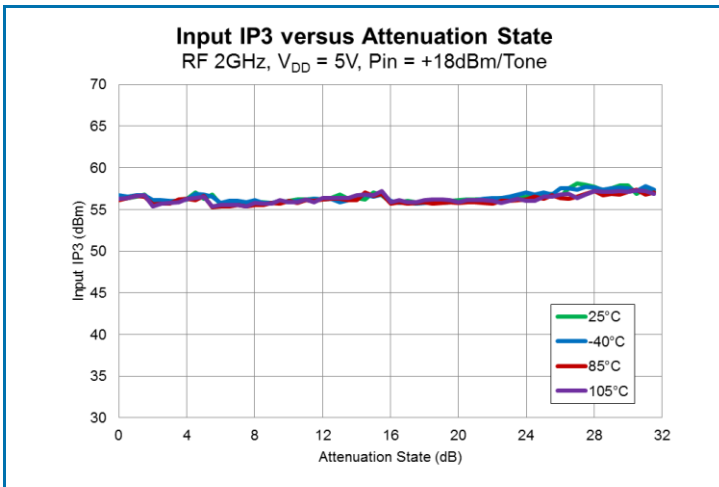
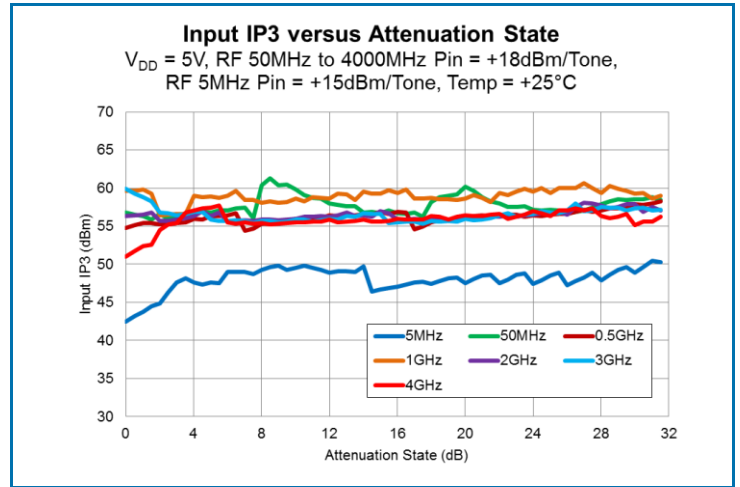
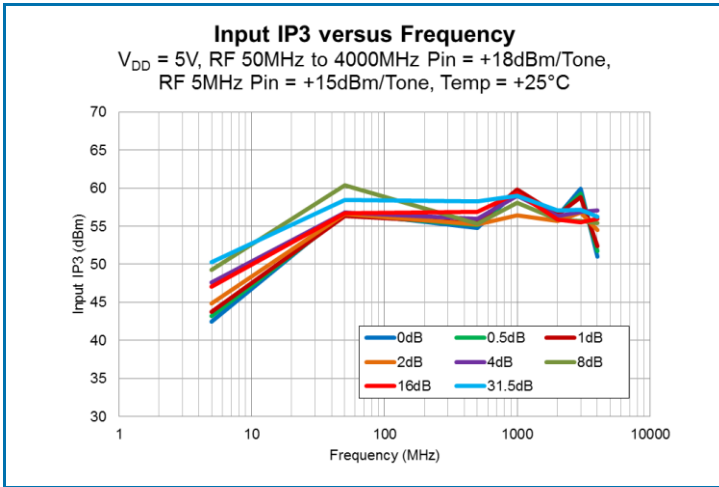



Evaluation Board Schematic

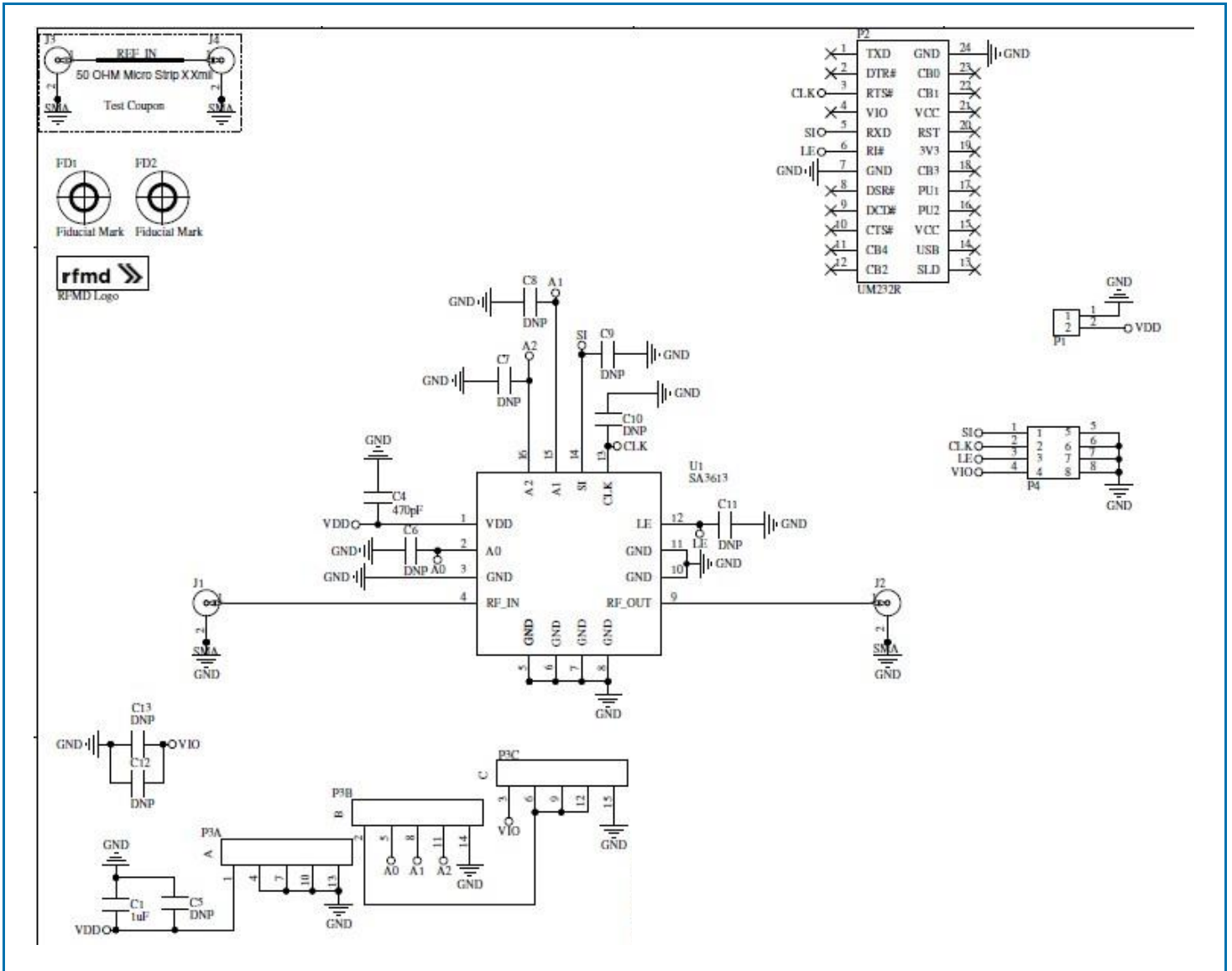

## Evaluation Board Bill of Materials (BOM)

Description	Reference Designator	Manufacturer	Manufacturer's P/N
RFSA3613-410		Dynamic Details (DDI) Toronto	RFSA3613-410(B)
Digital Step Attenuator, 5MHz to 6000MHz	U1	RFMD	RFSA3613SB
CAP, 1 $\mu$ F, 10%, 25V, X7R, 1206	C1	Taiyo Yuden (USA), Inc.	CE TMK316BJ105KL-T
CONN, SMA, END LNCH, UNIV, HYB MNT, FLT	J1-J4	Molex	SD-73251-4000
CONN, HDR, ST, PLRZD, 2-PIN, 0.100"	P1	ITW Pancon	MPSS100-2-C
CONN, HDR, ST, 3 x 5, 0.100", T/H	P3	Samtec Inc.	TSW-105-07-L-T
CONN, HDR, 2 x 4, RA, 0.100", T/H	P4	Samtec Inc.	TSW-104-08-G-D-RA
CONN, SKT, 24-PIN DIP, 0.600", T/H	P2	Aries Electronics Inc.	24-6518-10
MOD, USB TO SERIAL UART, SSOP-28	M1 (See Note 1)	Future Technology Devices Int'l	UM232R
CAP, 470pF, 5%, 50V, C0G, 0402	C4	Murata Electronics	GRM1555C1H471JA01D
Jumpers	S1-S4 (See Note 2)	3M Interconnect Solutions	929950-00
DNP	C5-C13	N/A	N/A

### Notes:

1. M1 should be mounted into P2 with respect to the Pin 1 alignment of M1 and P2.
2. Jumpers S1-S4 installed on P3.

Evaluation Board Assembly Drawing

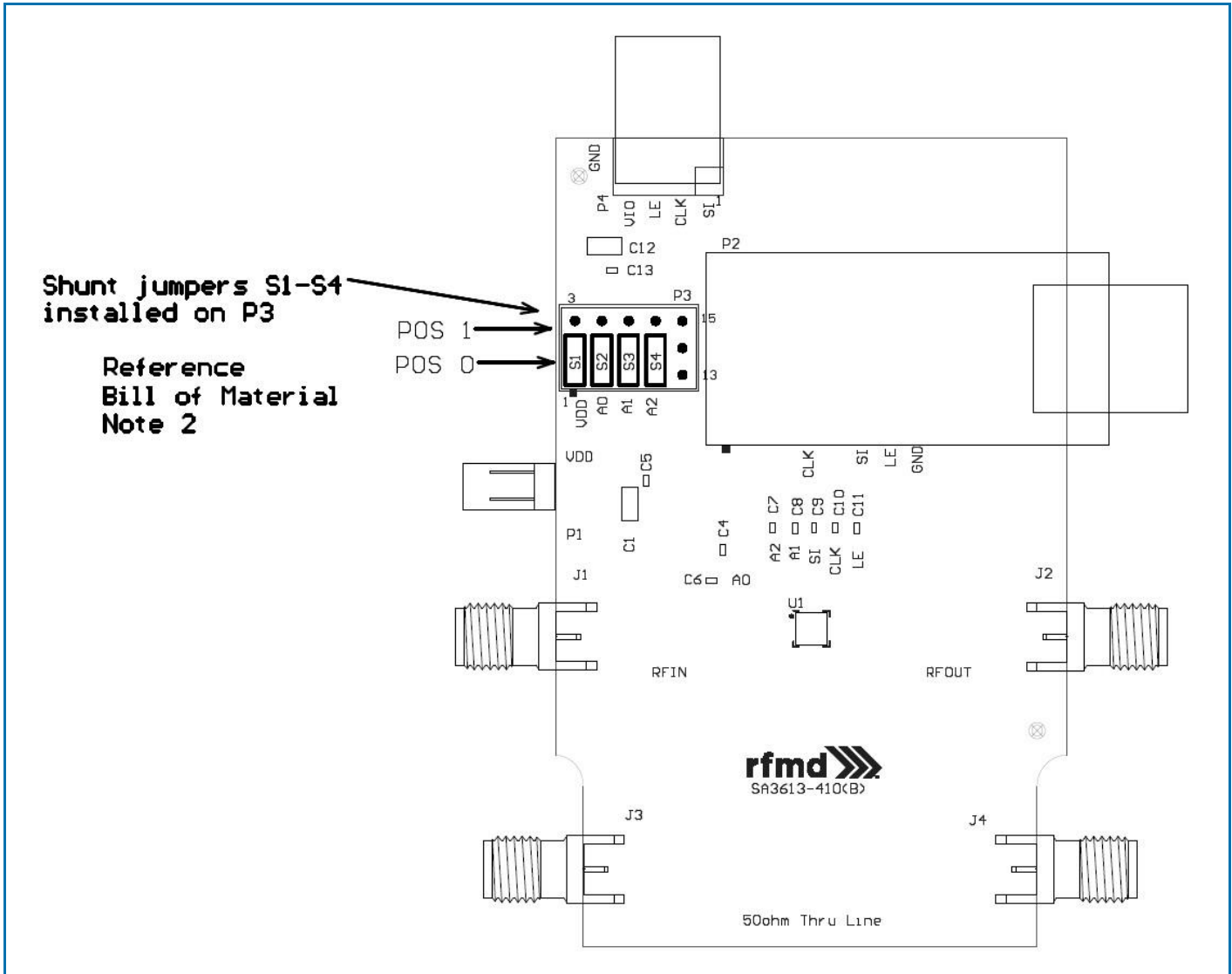

## Evaluation Board Jumper Programming

Jumpers	Connector	Signal	Position	U1 Connection	Comment
S1	P3	Logic Voltage	<b>0</b>	VDD (From P1)	
			1	VIO (From P4)	
S2		AO	<b>0</b>	GND	External Address
			1	U1_VDD	
S3		A1	<b>0</b>	GND	External Address
			1	U1_VDD	
S4		A2	<b>0</b>	GND	External Address
			1	U1_VDD	

Note: Default jumper settings are **BOLD**.

## Evaluation Board Programming Using USB Interface

### Serial Addressable Mode

All programming jumpers on the evaluation board are set to the default values indicated in the table. Refer to the Control Bit Generator (CBG) Software Reference Manual for detailed instructions on how to setup the software for use. Apply the supply voltage to P1. Select 'RFSA3613' from the RFMD Parts List of the CBG user interface. Set the attenuation value using the CBG user interface. The attenuator is set to the desired state and measurements can be taken. Note that the external address bits must all be set to '0' when using the USB interface as the CBG software does not have the capability to set the external address in the serial data stream at this time.

## Evaluation Board Programming Using External Bus

### Serial Addressable Mode

This configuration allows the user to control the attenuator through the P4 connector using an external harness. Remove the USB interface board if it is currently installed on the evaluation board. Connect a user-supplied harness to the P4 connector. Note that the top row of P4 contains the serial bus signals and the bottom row is ground. Programming jumper S1 is set to '0'. External address jumpers S2 through S4 can be set to any value desired by the user. Apply the supply voltage to P1. Send the appropriate signals onto the serial bus lines in accordance with the Serial Addressable Mode Timing Diagram. The attenuator is set to the desired state and measurements can be taken.

### Default Power-up State

This default attenuation state is maximum (31.5dB) when supply voltage is applied to the attenuator. The LE signal must be held to logic '0' during power-up.

## Pin Names and Descriptions

Pin	Name	Description
1	VDD	Supply Voltage
2	A0	A0 External Address Pin
3	GND	Ground Pin
4	RFIN	RF Input Pin Incident RF power must enter this pin for rated thermal performance and reliability Do not apply DC power to this pin. Pin may be DC grounded externally and is grounded thru resistors internal to the part.
5	GND	Ground Pin
6	GND	Ground Pin
7	GND	Ground Pin
8	GND	Ground Pin
9	RFOUT	RF Output Pin; Do not apply DC power to this pin. Pin may be DC grounded externally and is grounded thru resistors internal to the part.
10	GND	Ground Pin
11	GND	Ground Pin
12	LE	Latch Enable The leading edge of signal on LE causes the attenuator to change state
13	CLK	Serial Clock Input
14	SI	Serial data Input
15	A1	A1 External Address Pin
16	A2	A2 External Address Pin

## Serial Addressable Mode Attenuation Word Truth Table

Attenuation Word								Attenuation State
D7	D6	D5	D4	D3	D2	D1 (LSB)	D0	
X	L	L	L	L	L	L	X	0dB / Reference Insertion Loss
X	L	L	L	L	L	H	X	0.5dB
X	L	L	L	L	H	L	X	1dB
X	L	L	L	H	L	L	X	2dB
X	L	L	H	L	L	L	X	4dB
X	L	H	L	L	L	L	X	8dB
X	H	L	L	L	L	L	X	16dB
X	H	H	H	H	H	H	X	31.5dB

## Serial Addressable Mode Address Word Truth Table

Address Word								Address Setting
A7	A6	A5	A4	A3	A2 (MSB)	A1	A0	
X	X	X	X	X	L	L	L	000
X	X	X	X	X	L	L	H	001
X	X	X	X	X	L	H	L	010
X	X	X	X	X	L	H	H	011
X	X	X	X	X	H	L	L	100
X	X	X	X	X	H	L	H	101
X	X	X	X	X	H	H	L	110
X	X	X	X	X	H	H	H	111

## Serial Addressable Mode Timing Diagram

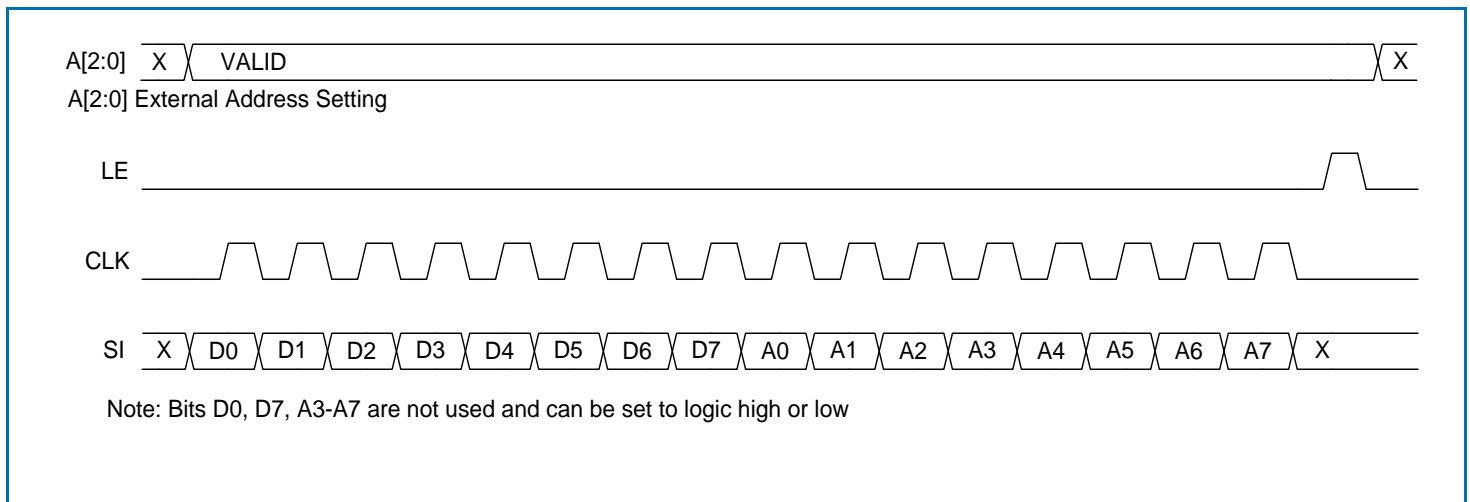

## Serial Bus Timing Specifications

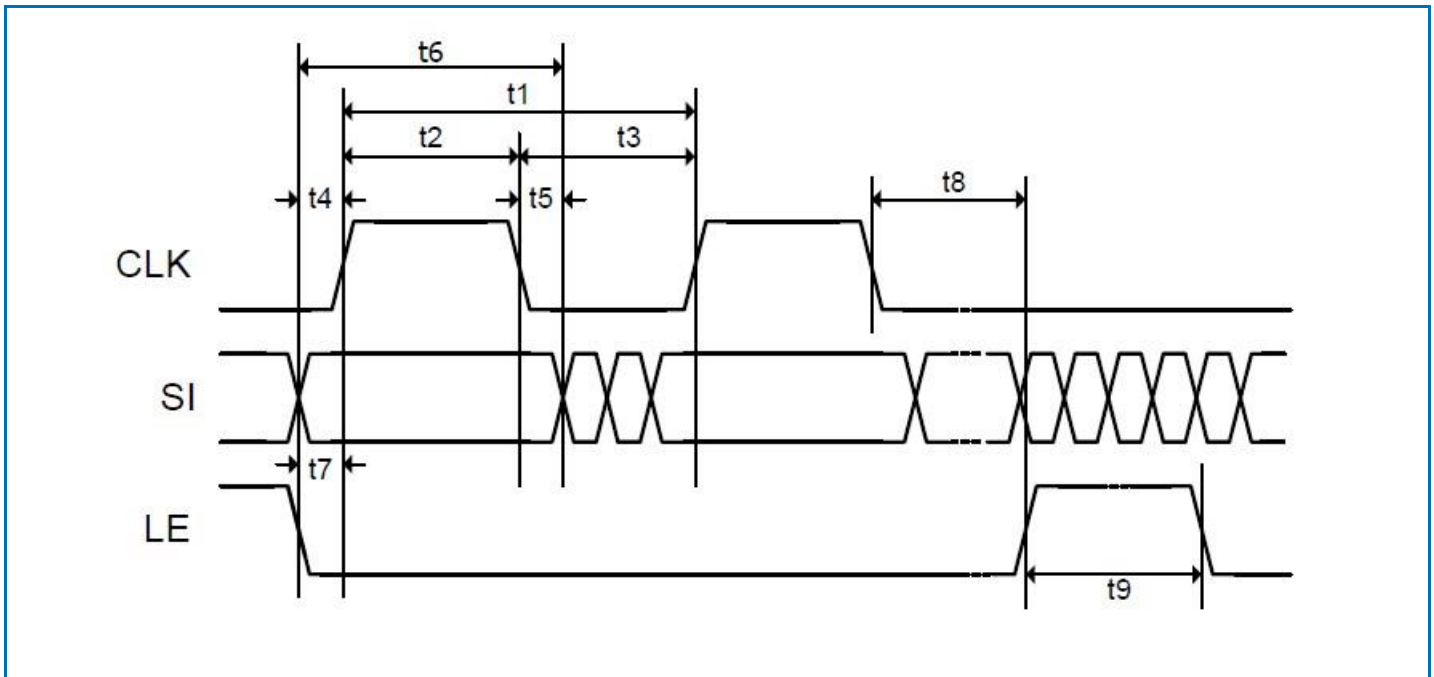

Parameter	Limit	Unit	Comment
$t_1$	25	MHz max	CLK Frequency
$t_2$	20	ns min	CLK High
$t_3$	20	ns min	CLK Low
$t_4$	5	ns min	SI to CLK Setup Time
$t_5$	5	ns min	SI to CLK Hold Time
$t_6$	30	ns min	SI Valid
$t_7$	5	ns min	LE to CLK Setup Time
$t_8$	5	ns min	CLK to LE Setup Time
$t_9$	10	ns min	LE Pulse Width

Package Drawing (Dimensions in millimeters)

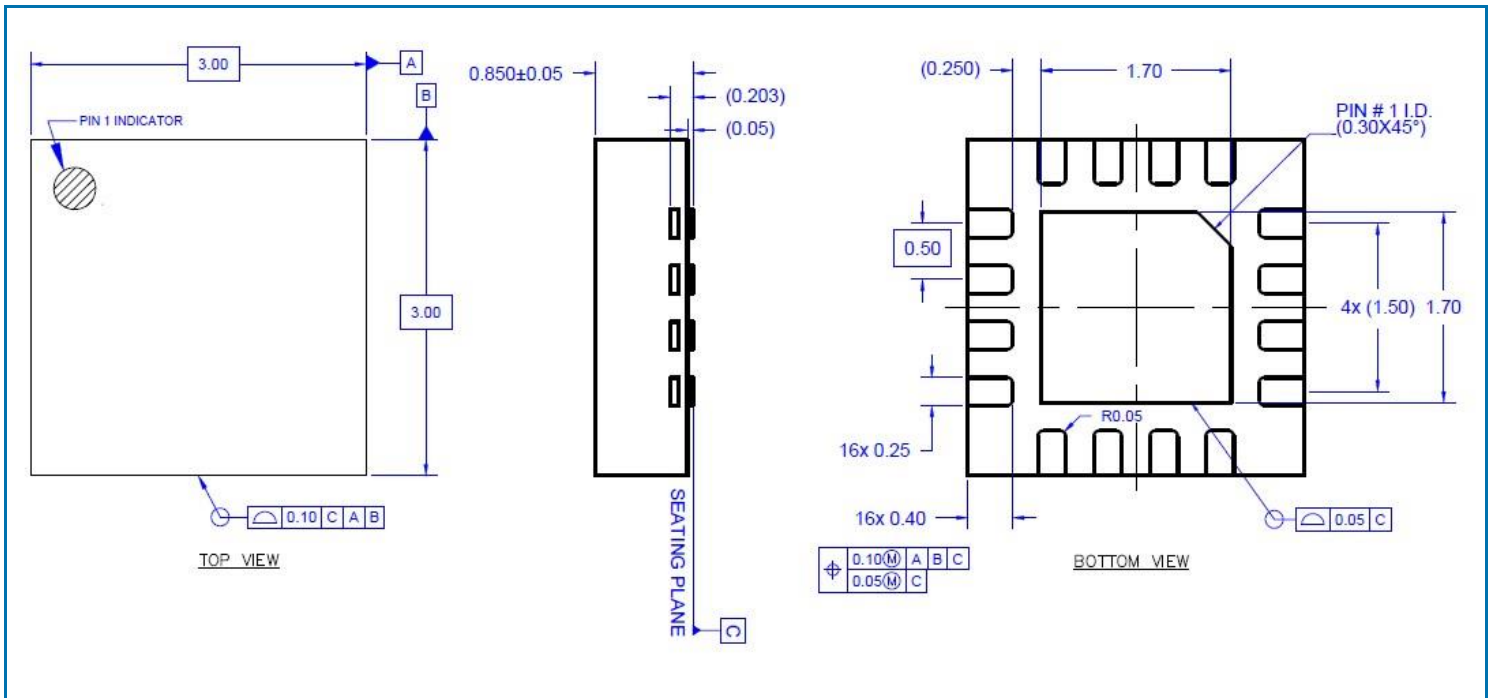

Branding Diagram

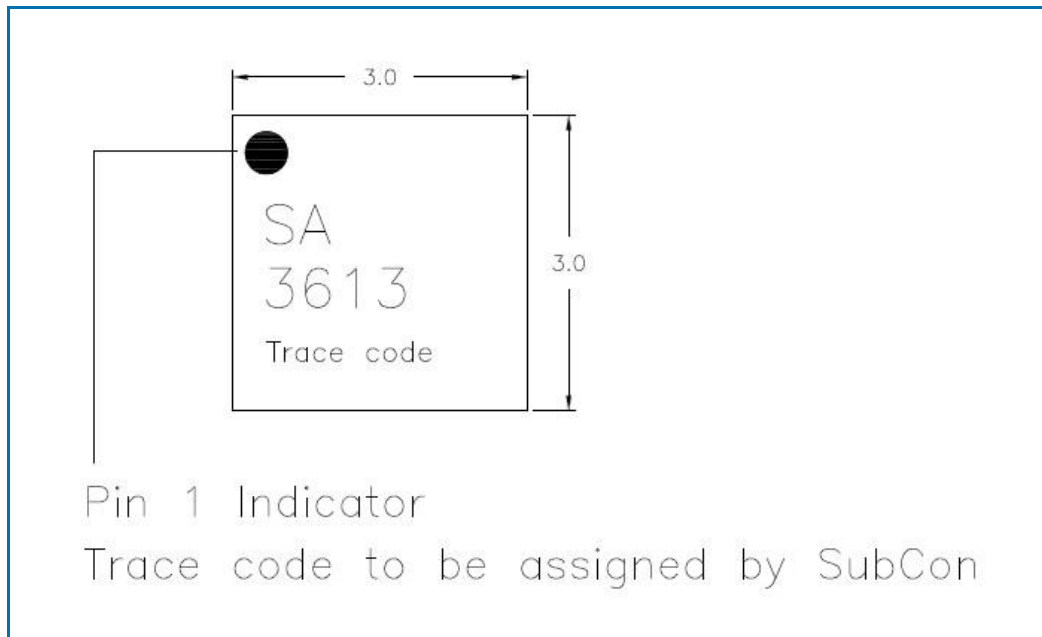



# Mouser Electronics

Authorized Distributor

Click to View Pricing, Inventory, Delivery & Lifecycle Information:

[Qorvo:](#)

[RFSA3613TR7](#) [RFSA3613SR](#) [RFSA3613PCK-410](#)