

SDS0402 Series

SMD Power Inductors

FEATURES

Smallest Size and High Performance.

High Energy Storage and Very Low Resistance.

ELECTRICAL CHARACTERISTICS

PART NO.	INDUCTANCE * (μ H)	Q Min.	Q FREQUENCY (KHz)	DC RESISTANCE (Ω) Max.	SRF (MHz) Typ.	I _{rms} ** (A)
SDS0402T-1R0M-N	1.0	30	200	0.040	200	3.00
SDS0402T-1R5M-N	1.5	30	200	0.045	100	2.80
SDS0402T-2R2M-N	2.2	40	200	0.050	90	1.80
SDS0402T-3R3M-N	3.3	40	200	0.060	90	1.60
SDS0402T-4R7M-N	4.7	40	200	0.065	80	1.40
SDS0402T-6R8M-N	6.8	40	200	0.070	40	1.20
SDS0402T-100M-N	10	40	200	0.075	30	1.00
SDS0402T-150M-N	15	40	100	0.090	25	0.80
SDS0402T-220M-N	22	40	100	0.110	20	0.70
SDS0402T-330M-N	33	40	100	0.190	15	0.60
SDS0402T-470M-N	47	40	100	0.230	15	0.50
SDS0402T-680M-N	68	40	100	0.290	10	0.40
SDS0402T-101M-N	100	40	100	0.480	8.0	0.30
SDS0402T-151M-N	150	40	100	0.590	7.0	0.26
SDS0402T-221M-N	220	40	100	0.770	4.0	0.22
SDS0402T-331M-N	330	40	100	1.4	4.0	0.20
SDS0402T-471M-N	470	40	100	1.8	3.0	0.19
SDS0402T-681M-N	680	40	100	2.2	2.0	0.18
SDS0402T-102M-N	1,000	40	100	3.4	1.0	0.15
SDS0402T-152M-N	1,500	50	100	4.2	1.0	0.12
SDS0402T-222M-N	2,200	50	100	8.5	1.0	0.10
SDS0402T-332M-N	3,300	50	100	11	0.5	0.08
SDS0402T-472M-N	4,700	50	100	13.9	0.5	0.06
SDS0402T-682M-N	6,800	50	100	25	0.5	0.04
SDS0402T-103M-N	10,000	50	100	32.8	0.4	0.02

Note:

* Inductance Tested at 1KHz, 1 Vrms.

** 30 °C Temperature Rise at I_{rms}.

Tolerance: M = \pm 20%

Operating Temperature Range: -40 °C to +85 °C



PRODUCT IDENTIFICATION

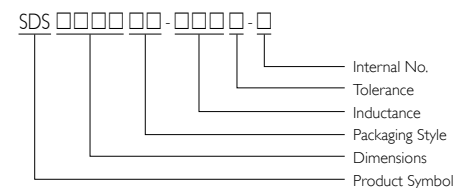

■ Packaging: T = Tape and Reel

■ Internal No.: N = Lead-Free

SHAPES AND DIMENSIONS

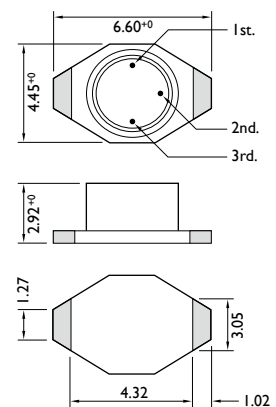

Dimensions: mm

SMD Power Inductors

SDS0402BL Series



PRODUCT IDENTIFICATION

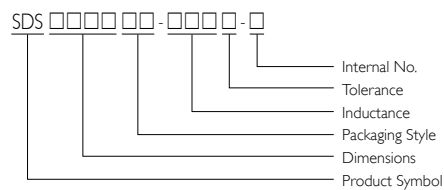

- Packaging: T = Tape and Reel
- Internal No.: N = Lead-Free

SHAPES AND DIMENSIONS

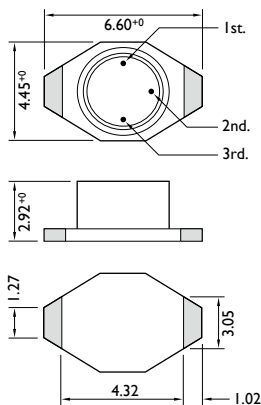

Dimensions: mm

APPLICATIONS

Notebook Computers, Step-up and Step-down Converters.

Flash Memory Programmers, etc.

OUTLINE

These shielded ultra-miniature inductors can help designers achieve significantly longer battery life in handheld communication devices and other portable products.

These magnetically shielded inductors are designed with a flat top and constructed of heat resistant materials to ensure trouble-free assembly and reflow operations.

FEATURES

Smallest Size and High Performance.

High Energy Storage and Very Low Resistance.

ELECTRICAL CHARACTERISTICS

PART NO.	INDUCTANCE * (mH)	DC RESISTANCE (Ω) Max.	INSULATION CORE-WINDING (M Ω)	SRF (MHz) Typ.	I _{rms} ** (A)
SDS0402BL-101M-N	0.10	0.95	> 10	12	220
SDS0402BL-151M-N	0.15	1.4	> 10	10	200
SDS0402BL-221M-N	0.22	1.7	> 10	8.0	180
SDS0402BL-331M-N	0.33	2.2	> 10	6.0	160
SDS0402BL-471M-N	0.47	3.8	> 10	5.0	140
SDS0402BL-681M-N	0.68	4.9	> 10	4.0	120
SDS0402BL-102M-N	1.0	9.0	> 10	2.0	100
SDS0402BL-152M-N	1.5	11	> 10	1.0	80
SDS0402BL-222M-N	2.2	19	> 10	1.0	50
SDS0402BL-332M-N	3.3	24	> 10	1.0	40
SDS0402BL-472M-N	4.7	30	> 10	1.0	30
SDS0402BL-682M-N	6.8	56	> 10	0.9	20
SDS0402BL-103M-N	10	74	> 10	0.8	10

Note:

* Inductance Tested at 100KHz, 0.1 Vrms.

** 30 °C Temperature Rise at I_{rms}.

Tolerance: M = \pm 20%

Operating Temperature Range: -40 °C to +85 °C

Electrical Specifications at 25 °C

SDS0804 Series

SMD Power Inductors

APPLICATIONS

Notebook Computers, Step-up and Step-down Converters.

Flash Memory Programmers, etc.

OUTLINE

These shielded ultra-miniature inductors can help designers achieve significantly longer battery life in handheld communication devices and other portable products.

These magnetically shielded inductors are designed with a flat top and constructed of heat resistant materials to ensure trouble-free assembly and reflow operations.

FEATURES

Smallest Size and High Performance.

High Energy Storage and Very Low Resistance.

ELECTRICAL CHARACTERISTICS

PART NO.	INDUCTANCE * (μ H)	Q Min.	Q FREQUENCY (KHz)	DC RESISTANCE (Ω) Max.	SRF (MHz) Typ.	Isat ** (A)	Irms *** (A)
SDS0804T-1R0M-N	1.0	3	100	0.021	110	5.6	5.0
SDS0804T-1R5M-N	1.5	5	100	0.022	90	5.2	4.5
SDS0804T-2R2M-N	2.2	5	100	0.032	60	5.0	3.8
SDS0804T-3R3M-N	3.3	5	100	0.039	55	3.9	3.3
SDS0804T-4R7M-N	4.7	10	100	0.054	30	3.2	2.7
SDS0804T-6R8M-N	6.8	10	100	0.075	30	2.8	2.2
SDS0804T-100M-N	10	10	100	0.101	28	2.4	2.0
SDS0804T-150M-N	15	15	100	0.150	20	2.0	1.5
SDS0804T-220M-N	22	20	100	0.207	15	1.6	1.3
SDS0804T-330M-N	33	20	100	0.334	12	1.4	1.1
SDS0804T-470M-N	47	20	100	0.472	10	1.0	0.8

Note:

* Inductance Tested at 100KHz, 0.1 Vrms.

** Inductance Drop = 10% Typ. at Rated Isat.

*** 40 °C Temperature Rise Typ. at Irms.

Tolerance: M = \pm 20%

Operating Temperature Range: -40 °C to +85 °C



PRODUCT IDENTIFICATION

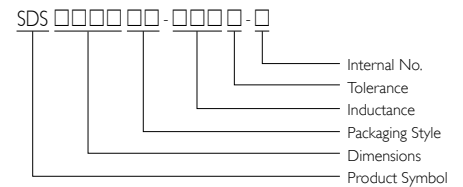

■ Packaging: T = Tape and Reel

■ Internal No.: N = Lead-Free

SHAPES AND DIMENSIONS

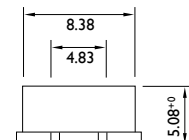
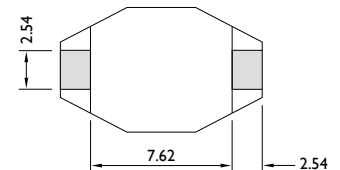
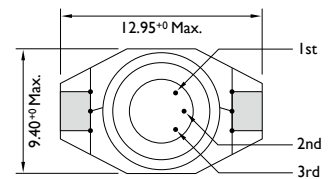

Dimensions: mm

SMD Power Inductors

SDS I 306 Series



PRODUCT IDENTIFICATION

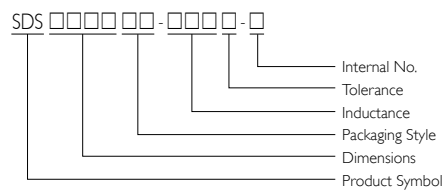

■ Packaging: T = Tape and Reel

■ Internal No.: N = Lead-Free

SHAPES AND DIMENSIONS

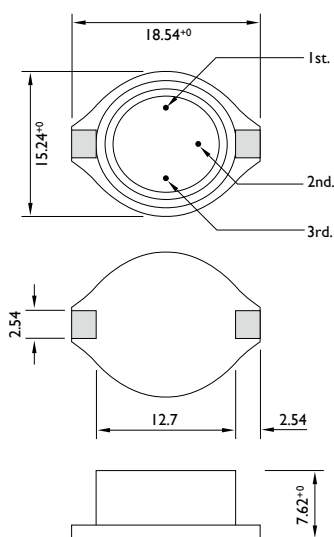

Dimensions: mm

APPLICATIONS

Notebook Computers, Step-up and Step-down Converters.

Flash Memory Programmers, etc.

OUTLINE

These shielded ultra-miniature inductors can help designers achieve significantly longer battery life in handheld communication devices and other portable products.

These magnetically shielded inductors are designed with a flat top and constructed of heat resistant materials to ensure trouble-free assembly and reflow operations.

FEATURES

Smallest Size and High Performance.

High Energy Storage and Very Low Resistance.

ELECTRICAL CHARACTERISTICS

PART NO.	INDUCTANCE * (μ H)	Q Min.	Q FREQUENCY (KHz)	DC RESISTANCE (Ω) Max.	SRF (MHz) Typ.	Isat ** (A)	Irms *** (A)
SDS I 306T-100M-N	10	40	100	0.040	24	5.50	3.90
SDS I 306T-150M-N	15	40	100	0.048	16	4.50	3.40
SDS I 306T-220M-N	22	30	100	0.059	14	3.50	3.10
SDS I 306T-330M-N	33	40	100	0.075	11	3.30	2.80
SDS I 306T-470M-N	47	40	100	0.097	8.0	2.70	2.40
SDS I 306T-680M-N	68	40	100	0.140	7.0	2.20	2.00
SDS I 306T-101M-N	100	40	100	0.210	5.5	1.70	1.70
SDS I 306T-151M-N	150	50	100	0.300	4.8	1.30	1.30
SDS I 306T-221M-N	220	50	100	0.470	4.0	1.10	1.10
SDS I 306T-331M-N	330	50	100	0.780	3.0	0.86	0.86
SDS I 306T-471M-N	470	50	100	1.08	2.4	0.73	0.73
SDS I 306T-681M-N	680	60	100	1.40	2.0	0.64	0.64
SDS I 306T-102M-N	1,000	60	100	2.01	1.0	0.53	0.53

Note:

* Inductance Tested at 100KHz, 0.1 Vrms.

** Inductance Drop = 10% Typ. at Rated Isat.

*** 40 °C Temperature Rise Typ. at Irms.

Tolerance: M = \pm 20%

Operating Temperature Range: -40 °C to +85 °C

TAPE DIMENSIONS

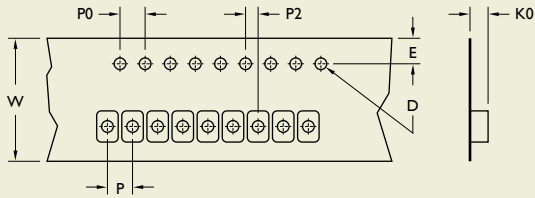

TAPE MATERIAL

Carrier Tape: Polystyrene

Cover Tape: Polyethylene

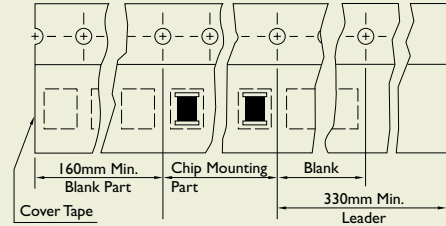

REEL DIMENSIONS

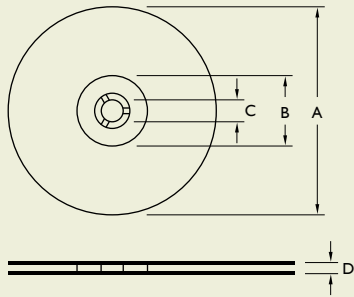

RECOMMENDED PATTERN

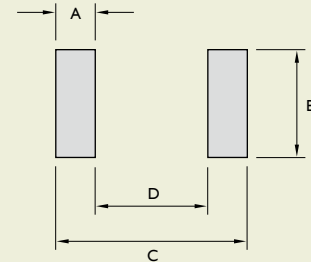

Dimensions: mm

TYPE	TAPE DIMENSIONS							RECOMMENDED PATTERN				REEL DIMENSIONS				QUANTITY/ REEL	
	K0	D	E	W	P	P0	P2	A	B	C	D	A	B	C	D	178	330
SDS0402T	3.2	1.55	1.75	12	8	4	2	1.40	3.56	6.86	4.06	330	100	13	13.4	-	2,500
												178	60	13	13.2	750	-
SDS0402BL	3.2	1.55	1.75	12	8	4	2	1.40	3.56	6.86	4.06	330	100	13	13.4	-	2,500
												178	60	13	13.2	750	-
SDS0804T	5.4	1.55	1.75	24	12	4	2	2.92	2.79	13.21	7.37	330	100	13	24.4	-	1,000
SDS1306T	7.5	1.55	1.75	32	20	4	2	2.92	2.79	18.29	12.45	330	100	13	33.4	-	250