

Width of 1.9mm contributes to thinner product designs and greater mounting efficiency



TACT Switch™

Sharp Feeling

Soft Feeling

Snap-In Type

Surface Mount Type

Radial Type

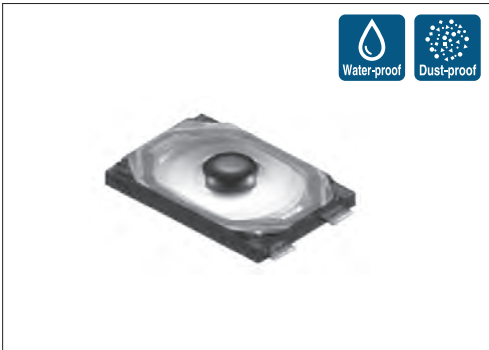

■ Typical Specifications

| Items | Specifications |
|----------------------------|--------------------|
| Rating (max.) | 50mA 12V DC |
| Rating (min.) | 10 μ A 1V DC |
| Initial contact resistance | 500m Ω max. |
| Travel (mm) | 0.12 |
| Protective structure ※ | IP67 equivalent |

■ Product Line

| Product No. | Operating force | Operating direction | Operating life (5mA 5V DC) | Minimum order unit (pcs.) | |
|-------------------|-----------------|---------------------|----------------------------|---------------------------|--------|
| | | | | Japan | Export |
| SKSVCAE010 | 1.6N | Top push | 300,000 cycles | 20,000 | 20,000 |
| SKSVCCE010 | 2.2N | | 100,000 cycles | | |

■ Packing Specifications

Taping

| Number of packages (pcs.) | | | Tape width (mm) | Export package measurements (mm) |
|---------------------------|----------------|-------------------------|-----------------|----------------------------------|
| 1 reel | 1 case / Japan | 1 case / export packing | | |
| 20,000 | 200,000 | 200,000 | 12 | 395×395×205 |

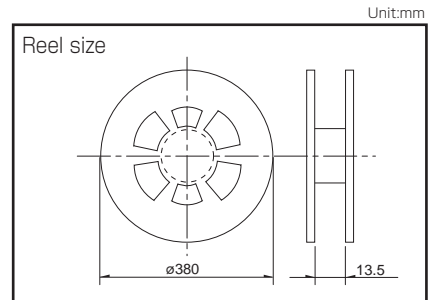

Note

For reels of 330mm diameter, please inquire.

■ Dimensions

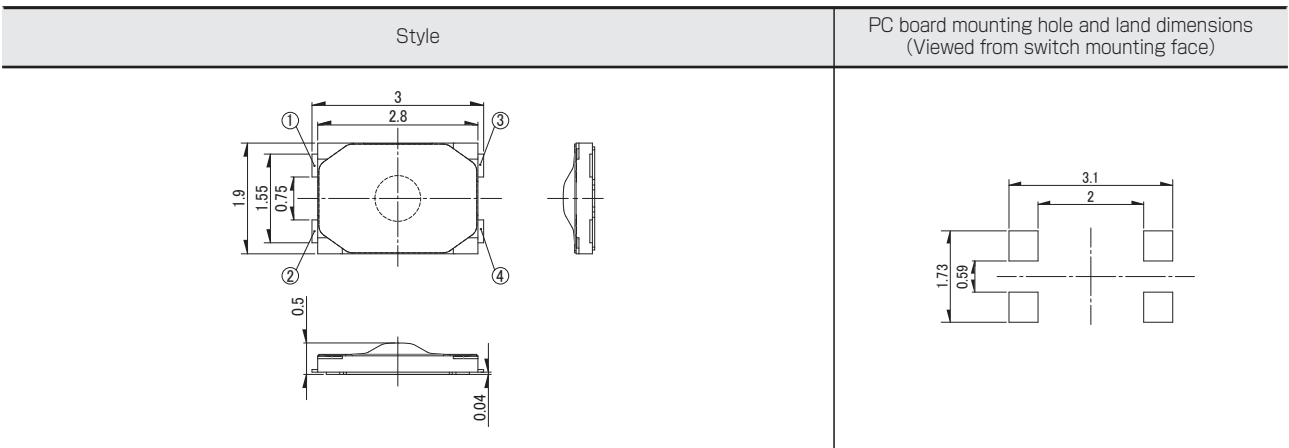



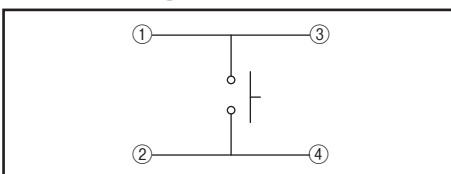

























■ Circuit Diagram



※ Assumes the switch is left alone without being operated. Under the specified conditions, dust and water ingress with a significant impact on the switch's on-off function is prevented.
IP67-level dust and water resistance is guaranteed for the switch alone and performance may not be guaranteed depending on the mounting conditions and usage.

Refer to P.235 for soldering conditions.

| Type | | Sharp Feeling Type | | | | | | | |
|-----------------------------|---|--|---|---|---|---|---|---|------|
| | | Surface Mount | | | | | | | |
| Series | | SKSD | SKRN | SKTA | SKSV | SKSW | SKTK | SKSG | |
| Photo | |  |  |  |  |  |  |  | |
| Features | | Double action | | Compact size Low-profile | | | Long life | High operation force Compact size | |
| Water-proof | | — | — | ● | ● | ● | ● | — | |
| Dustproof | | — | — | ● | ● | ● | ● | — | |
| IP standard | | — | — | 67 equivalent | 67 equivalent | 67 equivalent 68 equivalent in some cases | 67 equivalent | — | |
| Operating direction | Top push | ● | ● | ● | ● | ● | ● | ● | |
| | Side push | — | — | — | — | — | — | — | |
| Dimensions (mm) | W | 4.1 | □6 | 2.6 | 2.8 | 3 | 5.9 | 3 | |
| | D | 3.9 | | 1.6 | 1.9 | 2 | 4 | 2.7 | |
| | H | 0.6 | 0.9 | 0.53 | 0.5 | 0.6 | 0.78 | 1.4 | |
| Operation force coverage | 1N max. | See the relevant pages for respective product descriptions | |  | |  | |  | |
| | 1N to 2N | | | | | | | | |
| | 2N to 3N | | | | | | | | |
| | 3N to 4N | | | | | | | | |
| 4N to 5N |  | |  | |  | |  | | |
| 1N to 2N | | | | | | | | | |
| 2N to 3N | | | | | | | | | |
| 3N to 4N | | | | | | | | | |
| 4N to 5N |  | |  | |  | |  | | |
| 1N to 2N | | | | | | | | | |
| 2N to 3N | | | | | | | | | |
| 3N to 4N | | | | | | | | | |
| 4N to 5N |  | |  | |  | |  | | |
| 1N to 2N | | | | | | | | | |
| 2N to 3N | | | | | | | | | |
| 3N to 4N | | | | | | | | | |
| Travel (mm) | | See the relevant pages for respective product descriptions | | 0.11 | 0.12 | See the relevant pages for respective product descriptions | | 0.25 | 0.12 |
| Ground terminal | | ● | ● | — | — | — | — | ○ | |
| Operating temperature range | | -40°C to +90°C | | | -30°C to +85°C | | | -40°C to +85°C | |
| Automotive use | | — | — | — | — | — | — | ● | |
| Life Cycle | |  |  |  |  |  |  |  | |
| Electrical performance | Rating (max.) (Resistive load) | 50mA 12V DC | | | | | | | |
| | Rating (min.) (Resistive load) | 10μA 1V DC | | | | | | | |
| | Insulation resistance | 100MΩ min. 100V DC 1min. | | | | | | | |
| | Voltage proof | 100V AC 1min. | 250V AC 1min. | 100V AC 1min. | | | | | |
| Durability | Vibration | 10 to 55 to 10Hz/min., the amplitude is 1.5mm for all the frequencies, in the 3 direction of X, Y and Z for 2 hours respectively | | | | | | | |
| | Lifetime | Shall be in accordance with individual specifications. | | | | | | | |
| Environmental performance | Cold | -40°C 96h | | | | | | | |
| | Dry heat | 90°C 96h | | | | | | | |
| | Damp heat | 60°C, 90 to 95%RH 96h | | | | | | | |
| Page | | 195 | 196 | 197 | 198 | 199 | 201 | 202 | |

W : Width. The most outer dimension excluding terminal portion.

D : Depth. The most outer dimension excluding terminal portion.

H : Height. The minimum dimension if there are variances.

| | |
|-----------------------------------|-----|
| TACT Switch™ Soldering Conditions | 235 |
| TACT Switch™ Cautions | 236 |

Notes

- The automotive operating temperature range to be individually discussed upon request.
- Indicates applicability to all products in the series, while ○ indicates applicability to some products in the series.

Condition for Reflow

Available for Surface Mount Type.

Temperature profile

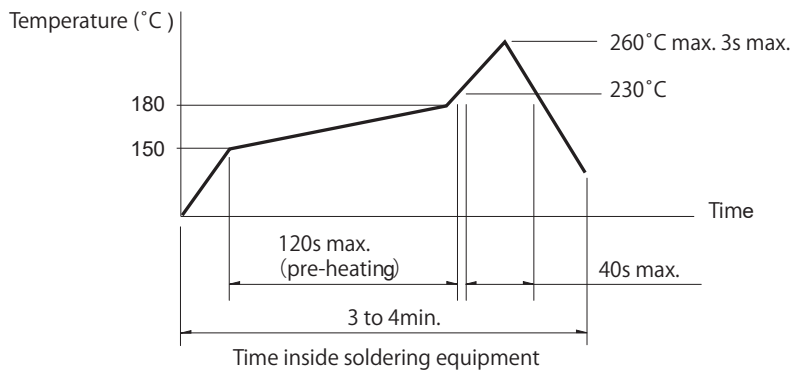

Notes

1. Please confirm the specifications of our product for the detailed condition.
2. Soldering conditions differ depending on reflow soldering machines.
Prior verification of soldering condition is highly recommended.

Conditions for Auto-dip

Available for Snap-in Type and Radial Type.

| Items | Condition |
|------------------------|---|
| Flux built-up | Mounting surface should not be exposed to flux |
| Preheating temperature | Ambient temperature of the soldered surface of PC board. 100°C max. |
| Preheating time | 60s max. |
| Soldering temperature | 260°C max. |
| Duration of immersion | 5s max. |
| Number of soldering | 2times max. |

SKHH Series

| Items | Condition |
|------------------------|---|
| Flux built-up | Mounting surface should not be exposed to flux |
| Preheating temperature | Ambient temperature of the soldered surface of PC board. 110°C max. |
| Preheating time | 60s max. |
| Soldering temperature | 260°C max. |
| Duration of immersion | 5s max. |
| Number of soldering | 2times max. |

SKHL Top Push Type, SKQJ Series

| Items | Condition |
|------------------------|---|
| Flux built-up | Mounting surface should not be exposed to flux |
| Preheating temperature | Ambient temperature of the soldered surface of PC board. 100°C max. |
| Preheating time | 45s max. |
| Soldering temperature | 255°C max. |
| Duration of immersion | 5s max. |
| Number of soldering | 2times max. |

Notes

1. Prevent flux penetration from the top side of the TACT Switch™.
2. Switch terminals and a PC board should not be coated with flux prior to soldering.
3. The second soldering should be done after the switch is stable with normal temperature.
4. Use the flux with a specific gravity of min 0.81.
(EC-19S-8 by TAMURA CORPORATION, or equivalents.)

Manual Soldering

| Items | Condition |
|----------------------------|------------|
| Soldering temperature | 350°C max. |
| Duration of soldering | 3s max. |
| Capacity of soldering iron | 60W max. |

SKHH, SKHW Series

| Items | Condition |
|----------------------------|------------|
| Soldering temperature | 360°C max. |
| Duration of soldering | 3s max. |
| Capacity of soldering iron | 60W max. |

SKTD, SKTG, SKQJ, SKSN Series

| Items | Condition |
|----------------------------|------------|
| Soldering temperature | 350°C max. |
| Duration of soldering | 3s max. |
| Capacity of soldering iron | 20W max. |