

MAPX	MODIFICATION	DATE	DRAW	APPROVE

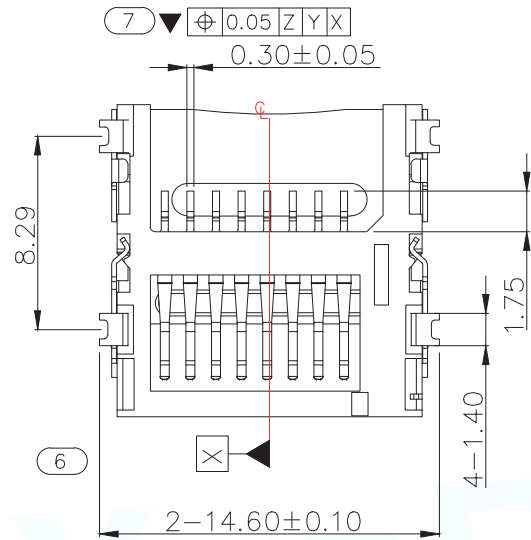

NOTE:  
 1.FINISH:  
 1-1.CONTACT: AU 1U" PLATING ON CONTACT AREA, 100~200" SN PLATING ON SOLDER TAILS, 50U" NICKEL UNDERPLATING VOER ALL;  
 1-2.SHELL: NO PLATING;  
 2.PRODUCT SPECIFICATIONS:  
 2-1.VOLTAGE RATING: 100V  
 2-2.CURRENT RATING: 0.5A  
 2-3.INSULATION RESISTANCE: 1000 MEG.OHM MIN  
 2-4.CONTACT RESISTANCE: 100 MILL.OHM MAX  
 2-5.OPERATION TEMPERATURE: -20° TO +85°

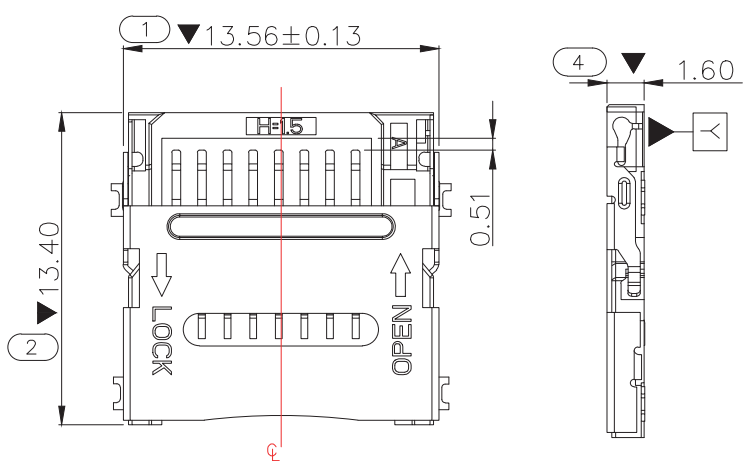
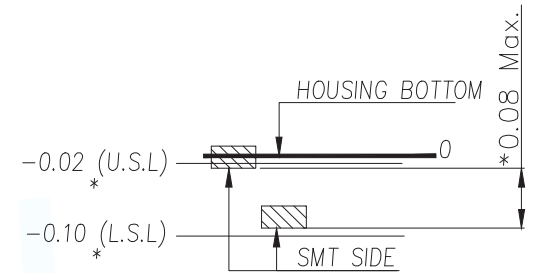

COPLANARITY(Shell&Signal pin)

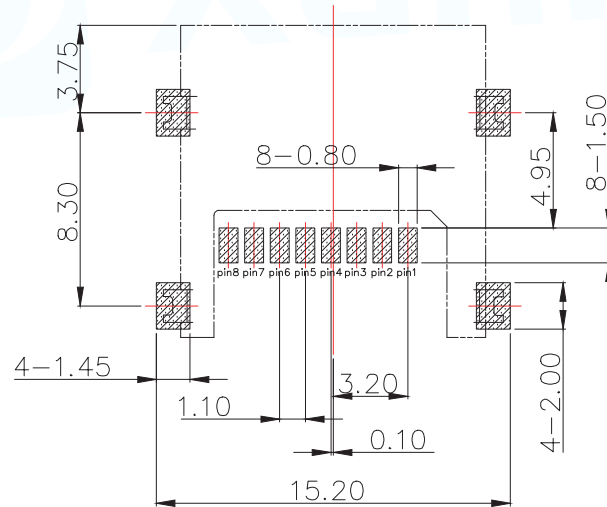
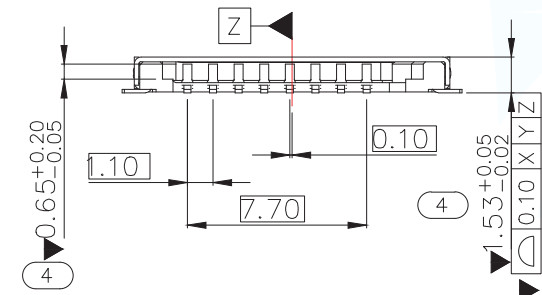

▨ PAD AREA  
 ■ KEEP OUT AREA

RECOMMENDED PCB LAYOUT  
 GENERAL TOLERANCE ±0.05

TF CARD PIN DEFINE			
PIN NO.	NAME	YYPE	DESCRIPTION
1	DAT2	I/O/PP	DATE LINE(BIT2)
2	CD/DAT3	I/O/PP	CARD DETECT DATE LIN(BIT3)
3	CMD	PP	COMMAND RESPONSE
4	VDD	S	SUPPLY VOLTAGE
5	CLX	I	CLOCK
6	VSS	S	SUPPLY VOLTAGE GROUND
7	DAT0	I/O/PP	DATE LINE(BIT0)
8	DAT1	I/O/PP	DATE LINE(DIT1)

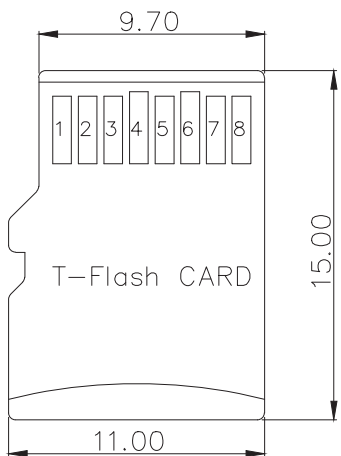
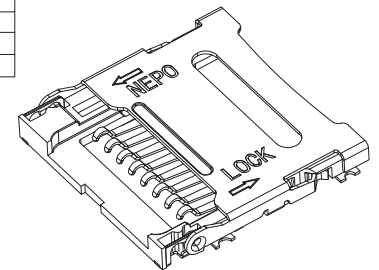

MANUFACTURE DWG			 东莞市讯普电子科技有限公司 DongGuan XunPu Electronics Co.,Ltd	
UNLESS OTHERWISE SPECIFIED TOLERANCES			TITLE: T-FLASH CARD HINGED H1.6 掀盖T卡	
DECIMALS:	ANGLES:		PAR	TF-102-18
X.: ±0.50	X.°: ±2°	DWN		
X.X: ±0.30	X.X°: ±1°	CHKD		
X.XX: ±0.20	X.XX°: ±0.5°	APVD		
CUSTOMER COPY		SCALE:1:1	UNIT: MM	
		SIZE: A4	SHEET: 1F1	
				REV: A

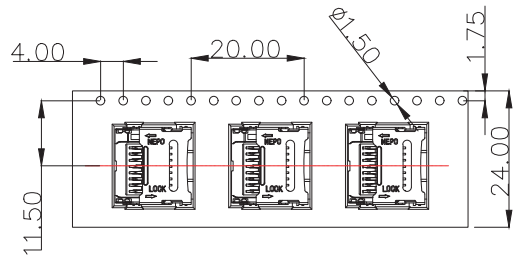
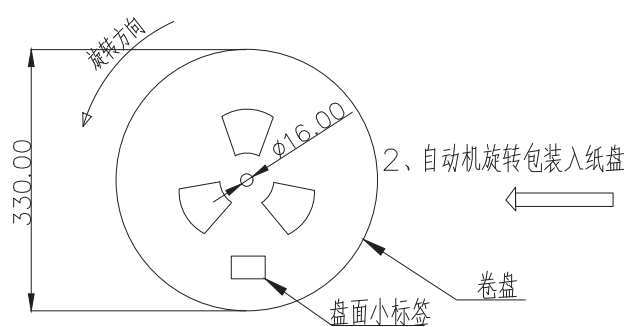

1、产品平整包装入载带

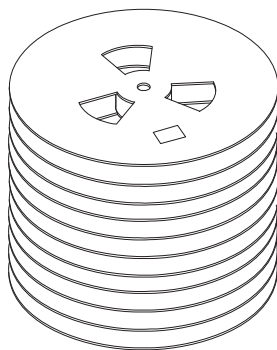
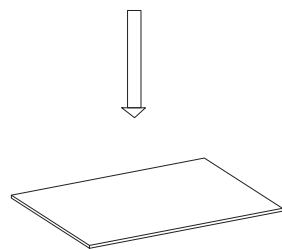
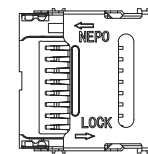

天地板

3、11 盘整齐叠放，上下各加一块天地板

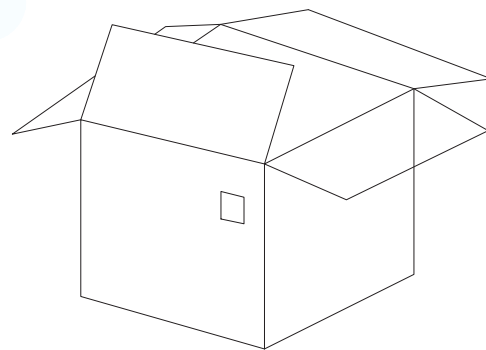

4、装箱

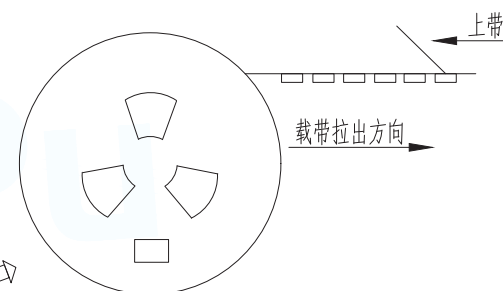

NOTE:

- 1. QUANTITY/1500 PCS  
数量/卷: 1500PCS
- 2. QUANTITY/INNER  
CARTON: 1500X11=16500PCS  
数量/箱: 1500X10=15000PCS
- 3. FREE 25 CAVE THE FRONT CARRIER  
ADN FREE  
25 CAVE IN THE END CARRIER  
包装带内圈空25格, 外圈空25格

MANUFACTURE DWG		东莞市讯普电子科技有限公司 DongGuan XunPu Electronics Co.,Ltd	
UNLESS OTHERWISE SPECIFIED TOLERANCES			TITLE: T-FLASH CARD HINGED H1.6 掀盖T卡
DECIMALS:	ANGLES:		PAR TF-102-18
X.: ±0.50	X.°: ±2°		DWN
X.X: ±0.30	X.X°: ±1°		CHKD
X.XX: ±0.20	X.XX°: ±0.5°	APVD	SCALE: 1:1
CUSTOMER COPY		SIZE: A4	UNIT: MM
		SHEET: 1F1	REV: A