

Linear Choke, open version, without socket

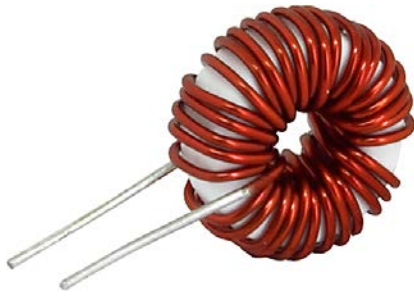

See below:

**Approvals and Compliances**

**Description**

- Linear choke
- Wire leads
- Open version without socket and chassis

**Applications**

- Smoothing RFI suppression choke
- RFI suppression choke
- Chopper amplifiers
- DC drives and stepper motor controls
- Switching power supplies

**Weblinks**

[pdf data sheet](#), [html datasheet](#), [General Product Information](#), [Approvals](#), [Distributor-Stock-Check](#), [Detailed request for product](#)

**Technical Data**

	to 600 VDC		
Rated Current	0.45 - 7 A @ Ta 70 °C	Isolation Voltage	2 kV eff., winding to ambient
Rated inductance	0.02 - 5 mH, Tol. ±15%	Climatic Category	40/125/21 acc. to IEC 60068-1
Power Operating Frequency	up to 20 kHz	Allowable Operation Temp.	-40 °C to 125 °C
Terminal Type	Wire leads		
Weight	10 - 12 g		

**Approvals and Compliances**

Detailed information on product approvals, code requirements, usage instructions and detailed test conditions can be looked up in [Details about Approvals](#)

SCHURTER products are designed for use in industrial environments. They have approvals from independent testing bodies according to national and international standards. Products with specific characteristics and requirements such as required in the automotive sector according to IATF 16949, medical technology according to ISO 13485 or in the aerospace industry can be offered exclusively with customer-specific, individual agreements by SCHURTER.





**Application standards**

Application standards where the product can be used

Organization	Design	Standard	Description
	Designed for applications acc.	IEC/UL 62368-1	Audio/video, information and communication technology equipment - Part 1: Safety requirements
	Designed for applications acc.	IEC 60601-1	Medical electrical equipment - Part 1: General requirements for basic safety and essential performance

**Compliances**

The product complies with following Guide Lines

Identification	Details	Initiator	Description
	<a href="#">CE declaration of conformity</a>	SCHURTER AG	The CE marking declares that the product complies with the applicable requirements laid down in the harmonisation of Community legislation on its affixing in accordance with EU Regulation 765/2008.
	<a href="#">UKCA declaration of conformity</a>	SCHURTER AG	The UKCA marking declares that the product complies with the applicable requirements laid down in the British Amendment of Regulation (EC) 765/2008.
	RoHS	SCHURTER AG	Directive RoHS 2011/65/EU, Amendment (EU) 2015/863
	China RoHS	SCHURTER AG	The law SJ / T 11363-2006 (China RoHS) has been in force since 1 March 2007. It is similar to the EU directive RoHS.
	REACH	SCHURTER AG	On 1 June 2007, Regulation (EC) No 1907/2006 on the Registration, Evaluation, Authorization and Restriction of Chemicals 1 (abbreviated as "REACH") entered into force.

**Dimension [mm]**

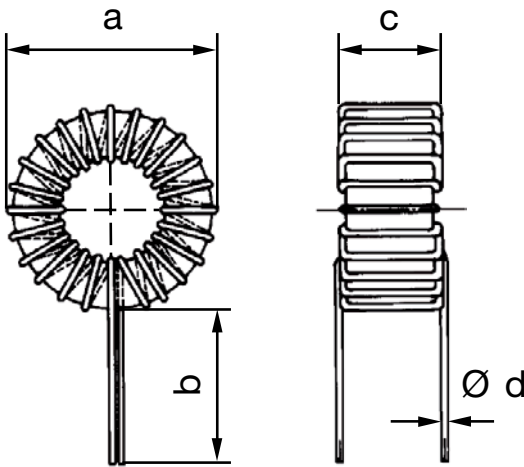

Dimensions: see table of variants

**Diagrams**

Application in DC-DC Converter

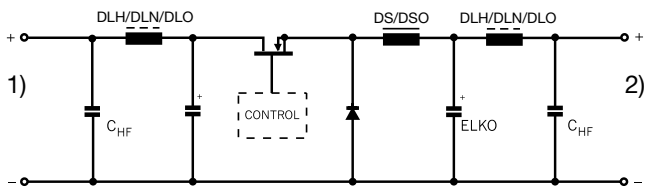

- 1) DC-Input unregulated
- 2) DC-Output regulated

### Derating Curves

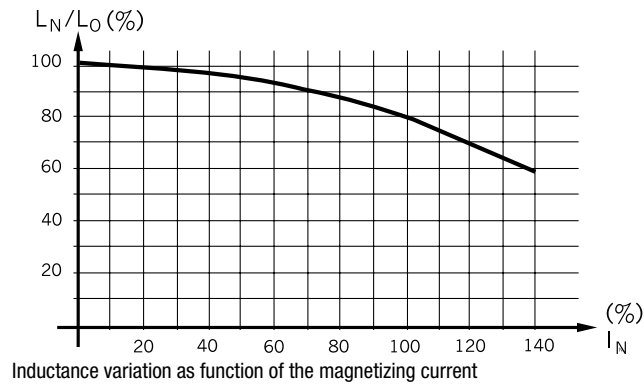

### All Variants

$I_n$ [A]	$L_n$ [mH]	$R_{cu}$ [mΩ]	$f_{RES}$ [MHz]	Inductance drop max [%]	A [mm]	B [mm]	C [mm]	D [mm]	Weight [g]	Packing unit [pcs.]	Order Number
0.45	5	3000	0.3	20	20 mm	15 mm	10 mm		10 g	200	DL01-24-0008
0.6	3	1550	0.4	20	20 mm	36 mm	10 mm		11 g	200	DL01-24-0007
1.0	1	600	0.8	20	20 mm	15 mm	10 mm		10 g	200	DL01-24-0006
1.5	0.5	280	1.3	20	20 mm	15 mm	10 mm		10 g	200	DL01-24-0005
1.8	0.3	178	2	20	20 mm	15 mm	10 mm		10 g	200	DL01-24-0004
3	0.1	70	8.2	20	20 mm	36 mm	10 mm		10 g	200	DL01-24-0003
4.5	0.05	26	8.4	20	20 mm	15 mm	10 mm	0.9 mm	11 g	200	DL01-24-0002
7	0.02	12	20.2	20	20 mm	36 mm	10 mm	1.2 mm	12 g	150	DL01-24-0001

$R_{cu}$  bei  $T_u$  20°C  
 Inductance drop with  $I_n$   
 Derating at  $T_u > 70^\circ\text{C}$ :  $I = I_{nx} \cdot ((125 - T_u)/55)^{0.5}$

Availability for all products can be searched real-time: <https://www.schurter.com/en/Stock-Check/Stock-Check-SCHURTER>