

## 1. High Frequency Use (Non Magnetic Core) RF, RE, **ND, NC, NA**

**Discontinued : Wirewound Chip Inductor. ELJND, ELJNC, ELJNA**



### ■ Features

- High frequency capability due to its non magnetic core.
- Capable of being Re-flow or flow soldered.
- Wide line-up from 1005 to 3225 case sizes.
- Good for mounting.
- RoHS compliant

### ■ Recommended Applications

- RF circuitry for cellular phones and wireless communication equipment.

### ■ Explanation of Part Numbers

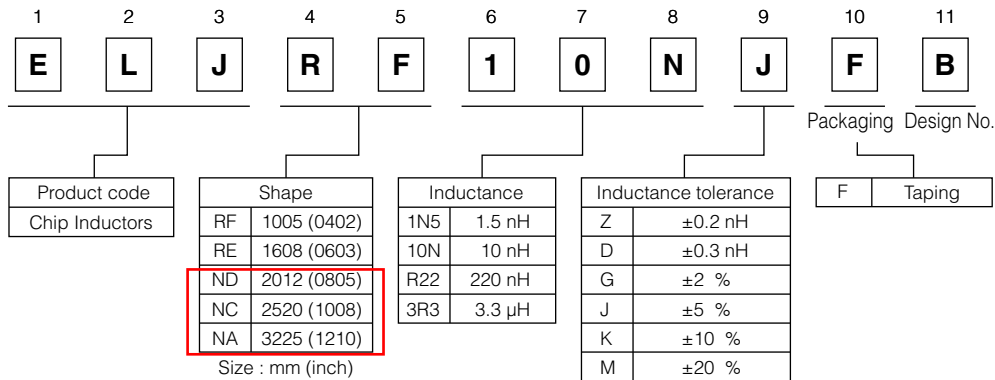

### ■ Storage Conditions

- Package : Normal temperature (-5 to 35 °C), normal humidity (85 %RH max.), shall not be exposed to direct sunlight and harmful gases and care should be taken so as not to cause dew.
- Operating Temperature : -40 to +85 °C (RF, RE)  
-20 to +85 °C (ND, NC, NA)

### ■ Storage Period

- Solderability may be reduced due to the conditions of high temperature and high humidity which causes the oxidation of tin-plated terminals. Even if storage conditions are within specified limits, solderability may be reduced with the passage of time. Therefore, please control the storage conditions and try to use the product within 6 months of receipt.

### ■ Packaging Methods, Soldering Conditions and Safety Precautions

Please see Data Files.

■ ND Type 2012 (0805) Discontinued : Wirewound Chip Inductor. ELJND, ELJNC, ELJNA

● Dimensions in mm (not to scale)

● Recommended Land Pattern in mm (not to scale)

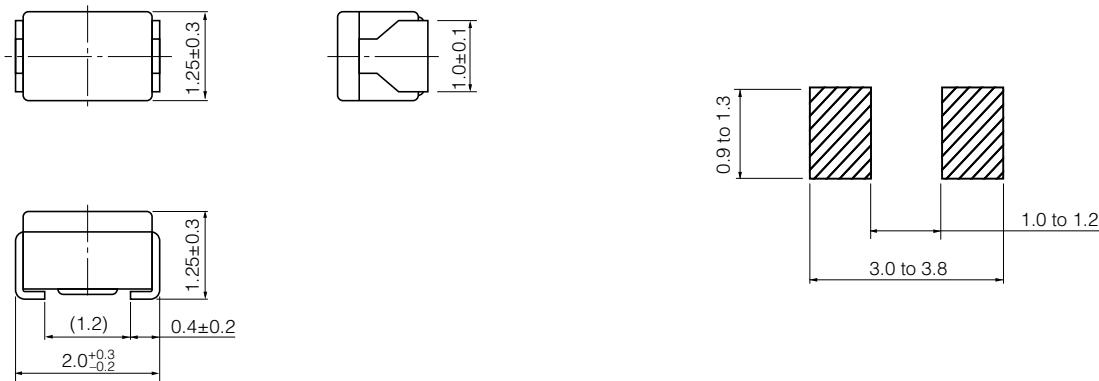

■ Standard Packing Quantity

● 3000 pcs./Reel

■ Standard Parts

Part No.	Inductance			Q		SRF *1 (MHz) min.	R <sub>DC</sub> *2 (Ω) max.	DC Current (mA) max.
	(nH)	Tolerance (%)	Test Freq. (MHz)	min.	Test Freq. (MHz)			
ELJND10N□F	10	K : ±10 %	100	10	100	3300	0.18	540
ELJND12N□F	12					3300	0.24	535
ELJND15N□F	15					3000	0.24	520
ELJND18N□F	18					3000	0.29	480
ELJND22N□F	22					2600	0.29	465
ELJND27N□F	27			2500		0.34	455	
ELJND33N□F	33			2050		0.39	395	
ELJND39N□F	39			2000		0.41	390	
ELJND47N□F	47			1650		0.46	385	
ELJND56N□F	56			1550		0.51	360	
ELJND68N□F	68			1450		0.57	340	
ELJND82N□F	82	1100	0.63	330				
ELJNDR10□F	100	K : ±10 % or J : ±5 %	25.2	8	25.2	800	0.86	285
ELJNDR12□F	120					600	0.99	275
ELJNDR15□F	150			600		1.47	230	
ELJNDR18□F	180			600		1.61	195	
ELJNDR22□F	220			500		1.84	170	
ELJNDR27□F	270			300		1.95	165	
ELJNDR33□F	330			200		2.16	160	
ELJNDR39□F	390			150		2.37	150	
ELJNDR47□F	470			150		2.56	145	
ELJNDR56□F	560			100		2.69	140	
ELJNDR68□F	680			100		3.02	130	
ELJNDR82□F	820	80	3.38	125				
ELJND1R0□F	1000	7.96	8	7.96	80	3.88	120	

□ : Symbol of Tolerance \*1 : Self Resonant Frequency \*2 : DC Resistance

■ NC Type 2520 (1008)

Discontinued : Wirewound Chip Inductor. ELJND, ELJNC, ELJNA

● Dimensions in mm (not to scale)

● Recommended Land Pattern in mm (not to scale)

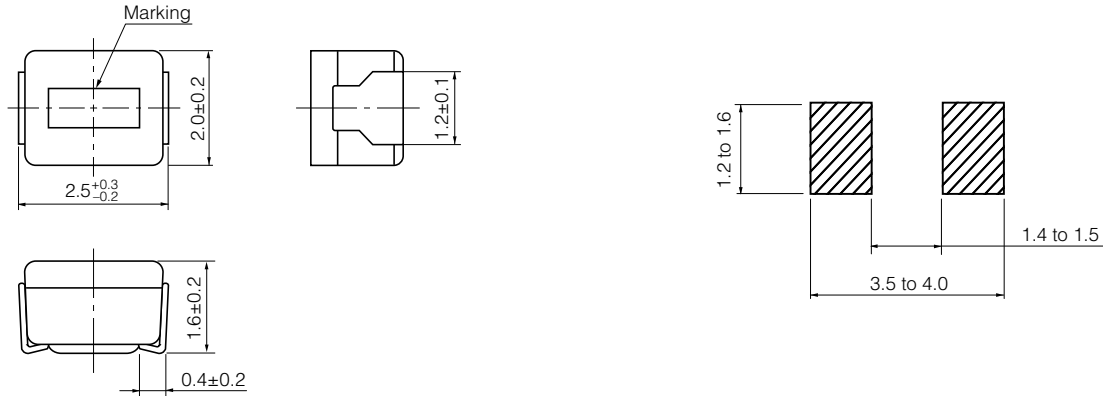

■ Standard Packing Quantity

● 2000 pcs./Reel

■ Standard Parts

Part No.	Inductance			Q		SRF *1 (MHz) min.	R <sub>DC</sub> *2 (Ω) max.	DC Current (mA) max.
	(nH)	Tolerance (%)	Test Freq. (MHz)	min.	Test Freq. (MHz)			
ELJNC10□F	10	K : ±10 %	100	10	100	2500	0.32	280
ELJNC12□F	12					2200	0.34	270
ELJNC15□F	15					1800	0.38	255
ELJNC18□F	18					1550	0.40	250
ELJNC22□F	22					1350	0.43	240
ELJNC27□F	27					1150	0.47	230
ELJNC33□F	33	K : ±10 % or J : ±5 %	25.2	15	25.2	1000	0.51	220
ELJNC39□F	39					890	0.55	215
ELJNC47□F	47					770	0.59	205
ELJNC56□F	56					670	0.63	200
ELJNC68□F	68					590	0.68	190
ELJNC82□F	82					520	0.73	185
ELJNCR10□F	100					460	0.80	175
ELJNCR12□F	120					400	0.87	170
ELJNCR15□F	150					340	0.98	160
ELJNCR18□F	180					300	1.05	155
ELJNCR22□F	220					260	1.15	145
ELJNCR27□F	270					230	1.25	140
ELJNCR33□F	330	200	1.37	135				
ELJNCR39□F	390	180	1.47	130				
ELJNCR47□F	470	160	1.58	125				
ELJNCR56□F	560	145	1.70	120				
ELJNCR68□F	680	130	1.85	110				
ELJNCR82□F	820	100	2.10	100				

□ : Symbol of Tolerance    \*1 : Self Resonant Frequency    \*2 : DC Resistance

■ NA Type 3225 (1210) Discontinued : Wirewound Chip Inductor. ELJND, ELJNC, ELJNA

● Dimensions in mm (not to scale)

● Recommended Land Pattern in mm (not to scale)

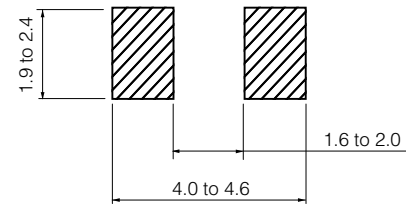
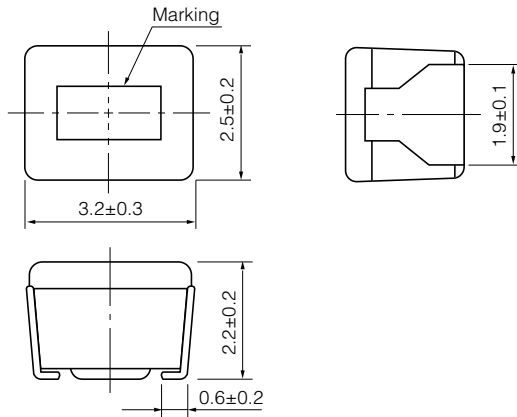

■ Standard Packing Quantity

● 2000 pcs./Reel

■ Standard Parts

Part No.	Inductance			Q		SRF *1 (MHz) min.	R <sub>bc</sub> *2 (Ω) max.	DC Current (mA) max.
	(nH)	Tolerance (%)	Test Freq. (MHz)	min.	Test Freq. (MHz)			
ELJNA47N□F	47	M : ±20 %	100	10	100	680	0.20	450
ELJNA56N□F	56					600	0.22	420
ELJNA68N□F	68					540	0.25	400
ELJNA82N□F	82					500	0.27	380
ELJNAR10□F	100					450	0.30	360
ELJNAR12□F	120					25.2	25.2	400
ELJNAR15□F	150	350	0.72	230				
ELJNAR18□F	180	320	0.81	220				
ELJNAR22□F	220	280	0.90	210				
ELJNAR27□F	270	250	1.0	200				
ELJNAR33□F	330	K : ±10 % or J : ±5 %	1	13	7.96			220
ELJNAR39□F	390					200	1.2	180
ELJNAR47□F	470					180	1.4	175
ELJNAR56□F	560					160	1.5	170
ELJNAR68□F	680					150	1.7	155
ELJNAR82□F	820					135	1.9	145
ELJNA1R0□F	1000	J : ±5 %	1	13	7.96	120	2.1	125
ELJNA1R2□F	1200					110	2.3	120
ELJNA1R5□F	1500					95	2.7	115
ELJNA1R8□F	1800					85	3.0	110
ELJNA2R2□F	2200					80	3.2	110
ELJNA2R7□F	2700					70	3.6	105
ELJNA3R3□F	3300					62	4.2	100
ELJNA3R9□F	3900					57	4.4	95
ELJNA4R7□F	4700					52	7.7	70
ELJNA5R6□F	5600					46	8.7	65
ELJNA6R8□F	6800	42	10	60				
ELJNA8R2□F	8200	38	11	60				

□ : Symbol of Tolerance \*1 : Self Resonant Frequency \*2 : DC Resistance

Design and specifications are each subject to change without notice. Ask factory for the current technical specifications before purchase and/or use. Should a safety concern arise regarding this product, please be sure to contact us immediately.

### ■ Packaging Methods (Taping)

#### ● Punched Carrier Tape Dimensions in mm (not to scale)

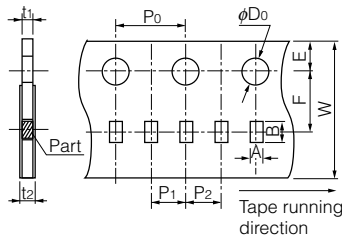

#### ● Embossed Carrier Tape Dimensions in mm (not to scale)

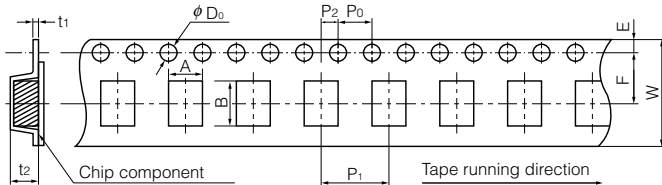
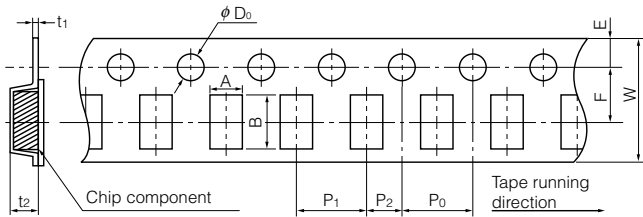
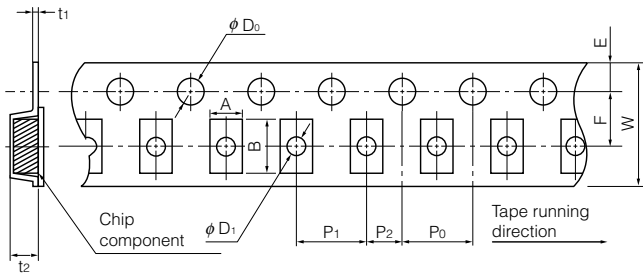

#### ● Taping Reel Dimensions in mm (not to scale)

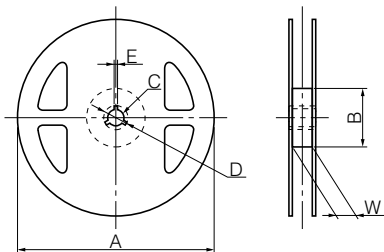

### ■ Standard Packing Quantity/Reel

Types	Quantity	Quantity
RF, QF, PF		10000 pcs.
RE, QE, PE, ND		3000 pcs.
NC, FC, PC, LC, SC		2000 pcs.
NA, FA, PA, LA, SA, EA, DA		2000 pcs.
FB, PB		500 pcs.

#### ● Type □F

	A	B	W	E	F	P <sub>1</sub>
RF, QF, PF	0.71	1.21	8.0	1.75	3.5	2.0
	P <sub>2</sub>	P <sub>0</sub>	φD <sub>0</sub>	t <sub>1</sub>	t <sub>2</sub>	
RF, QF, PF	2.0	4.0	φ1.5	0.7 max.	1.0 max.	

#### ● Type □E, Type ND, Type □C

	A	B	W	E	F	P <sub>1</sub>
RE, QE, PE	1.0	1.8	8.0	1.75	3.5	4.0
ND	1.45	2.25	8.0	1.75	3.5	4.0
NC, FC, PC, LC, SC	2.40	2.90	8.0	1.75	3.5	4.0
	P <sub>2</sub>	P <sub>0</sub>	φD <sub>0</sub>	φD <sub>1</sub>	t <sub>1</sub>	t <sub>2</sub>
RE, QE, PE	2.0	4.0	φ1.5	φ0.6	(0.27)	1.2
ND	2.0	4.0	φ1.5	φ1.0	(0.25)	1.55
NC, FC, PC, LC, SC	2.0	4.0	φ1.5	φ1.1	(0.25)	1.85

#### ● Type □A

	A	B	W	E	F	P <sub>1</sub>
NA, FA, PA, LA, SA, EA, DA	2.80	3.60	8.0	1.75	3.5	4.0
	P <sub>2</sub>	P <sub>0</sub>	φD <sub>0</sub>	t <sub>1</sub>	t <sub>2</sub>	
NA, FA, PA, LA, SA, EA, DA	2.0	4.0	φ1.5	(0.25)	2.40	

#### ● Type □B

	A	B	W	E	F	P <sub>1</sub>
FB, PB	3.60	4.90	12.0	1.75	5.5	8.0
	P <sub>2</sub>	P <sub>0</sub>	φD <sub>0</sub>	t <sub>1</sub>	t <sub>2</sub>	
FB, PB	2.0	4.0	φ1.5	(0.30)	3.50	

Types	Parts					
	A	B	C	D	E	W
RF, QF, PF, RE, QE, PE, ND, NC, FC, PC, LC, SC, NA, FA, PA, LA, SA, EA, DA	180	60	13	21	2	9
FB, PB	180	60	13	21	2	13

\* Under conditions of high temperature and humidity deterioration of the taping and packaging may be accelerated.

Please carefully control storage conditions and use the product within 6 months of receipt.

## Soldering Conditions

### ■ Reflow soldering conditions

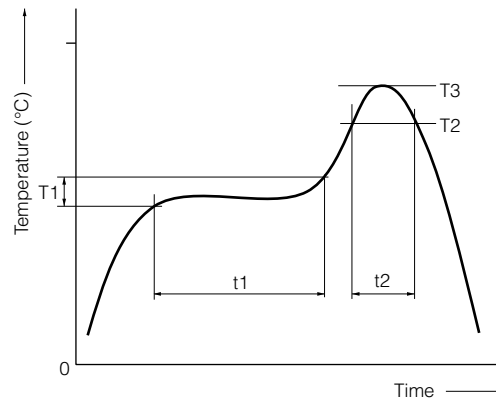

### ● Pb free solder recommended temperature profile

Type	Preheat		Soldering		Peak Temperature		Time of Reflow
	T1 [°C]	t1 [s]	T2 [°C]	t2 [s]	T3	T3 Limit	
□F	150 to 180	60 to 120	230 °C	40 max.	250 °C, 10 s	260 °C, 10 s	2 times max.
□E	150 to 180	60 to 120	230 °C	40 max.	250 °C, 10 s	260 °C, 10 s	2 times max.
□D	150 to 180	60 to 120	230 °C	40 max.	245 °C, 10 s	250 °C, 10 s	2 times max.
□C	150 to 180	60 to 120	230 °C	40 max.	245 °C, 10 s	250 °C, 10 s	2 times max.
□A	150 to 180	60 to 120	230 °C	40 max.	245 °C, 10 s	250 °C, 10 s	2 times max.
□B	150 to 180	60 to 120	230 °C	40 max.	245 °C, 10 s	250 °C, 10 s	2 times max.

### ■ Flow soldering conditions

Preheat: 130 to 150 °C, 60 to 180 s, Soldering: 260 °C, 5 s max.

### ■ Notes

- Solderability may be reduced due to the conditions of high temperature and high humidity which causes the oxidation of tin-plated terminals. Even if storage conditions are within specified limits, solderability may be reduced with the passage of time. Therefore, please control the storage conditions and try to use the product within 6 months of receipt.
- In case the product has been stored for a period longer than 6 months, use the product only after confirmation of its solderability.

## ⚠ Safety Precautions (Common precautions for Chip Inductors)

- When using our products, no matter what sort of equipment they might be used for, be sure to make a written agreement on the specifications with us in advance. The design and specifications in this catalog are subject to change without prior notice.
- Do not use the products beyond the specifications described in this catalog.
- This catalog explains the quality and performance of the products as individual components. Before use, check and evaluate their operations when installed in your products.
- Install the following systems for a failsafe design to ensure safety if these products are to be used in equipment where a defect in these products may cause the loss of human life or other significant damage, such as damage to vehicles (automobile, train, vessel), traffic lights, medical equipment, aerospace equipment, electric heating appliances, combustion/gas equipment, rotating equipment, and disaster/crime prevention equipment.
- \* Systems equipped with a protection circuit and a protection device
- \* Systems equipped with a redundant circuit or other system to prevent an unsafe status in the event of a single fault

## ⚠ Precautions for use

### 1. Operation range and environments

- ① These products are designed and manufactured for general and standard use in general electronic equipment (e.g. AV equipment, home electric appliances, office equipment, information and communication equipment)
- ② These products are not intended for use in the following special conditions. Before using the products, carefully check the effects on their quality and performance, and determine whether or not they can be used.
  - In liquid, such as water, oil, chemicals, or organic solvent
  - In direct sunlight, outdoors, or in dust
  - In salty air or air with a high concentration of corrosive gas, such as Cl<sub>2</sub>, H<sub>2</sub>S, NH<sub>3</sub>, SO<sub>2</sub>, or NO<sub>2</sub>
  - In an environment where these products cause dew condensation

### 2. Handling

- ① Do not bring magnets or magnetized materials close to the product. The influence of their magnetic field can change the inductance value.
- ② Do not apply strong mechanical shocks by either dropping or collision with other parts.  
Excessive shock can damage the part.

### 3. Land pattern design

- ① Please refer to the recommended land pattern for each type shown on the datasheet.
- ② Avoid placing the chip inductor on any metal pattern except the recommended land pattern because a drop of Q and mutual conductance may occur.
- ③ In case of flow soldering, venting of soldering flux gases should be made for high density assemblies to get a good solder connection.
- ④ In case of reflow soldering, consider the layout because taller components close to chip inductor tend to block thermal conduction.

### 4. Mounting

- ① In general, magnetic and electric characteristics of ferrite cores can be changed by applying excessively strong force. Placement force should not exceed 20 N.
- ② Do not bend or twist the PWB after mounting the part.

### 5. Cleaning

- ① Do not use acid or alkali agents. Some cleaning solvents may damage the part.  
Confirm by testing the reliability in advance of mass production.
- ② If Ultrasonic cleaning is used, please confirm the reliability in advance.  
It is possible that combined resonance of component and PWB and cavitation can cause an abnormal vibration mode to exist causing damage.

### 6. Caution about applying excessive current

The rated current is defined as the smaller value of either the current value when the inductance drops 10 % down from the initial point or the current value when the average temperature of coil inside rises 20 °C up from the initial point. Do not operate product over the specific max. current.

### <Package markings>

Package markings include the product number, quantity, and country of origin.  
In principle, the country of origin should be indicated in English.

Chip Inductors

Discontinued : Wirewound Chip Inductor. D, C, A, B

Type: F, E, D, C, A, B



Ceramic Core/Laser-Cut and wire wound type chip inductors for automatic and high-density mounting  
Wide variation product line-up correspond to various needs

### Recommended Applications

- Cellular phones, wireless communication equipment (W-LAN, Bluetooth), various modules, HIC, TV, VTR, PC & peripherals, DVD, DSC, STB.

### Inductors · Selection Guide

Size : mm (inch)

Technology Case Usage	Non wound		Wire wound <span style="border: 1px solid red; padding: 2px;">Discontinued</span>			
	Size 1005 (0402)	Size 1608 (0603)	Size 2012 (0805)	Size 2520 (1008)	Size 3225 (1210)	Size 4532 (1812)
High Freq. Use	ELJRF  1.0-100 nH	ELJRE  1.0-220 nH	ELJND  10-1000 nH	ELJNC  10-820 nH	ELJNA  47-8200 nH	
High Freq. High-Q	ELJQF  1.0-39 nH	ELJQE  2.2-56 nH				
General Use				ELJFC  0.22-100 μH	ELJFA  0.22-220 μH	ELJFB  0.22-1000 μH
High Power	ELJPF  2.2-10 nH	ELJPE  2.2-22 nH		ELJPC/PC□3 ELJLC  1.0-33 μH	ELJPA/PA□2 ELJLA  1.0-330 μH	ELJPB  10-220 μH
Magnetically Shielded				ELJSC  27-100 μH	ELJSA  10-270 μH	
Low DC Resistance					ELJEA  1.0-330 μH	
Signal Processing Use (Low Distortion Type)					ELJDA/ELJFA  39-100 μH	

Design and specifications are each subject to change without notice. Ask factory for the current technical specifications before purchase and/or use.  
Should a safety concern arise regarding this product, please be sure to contact us immediately.