

G3VM-62C1/F1

MOS FET Relays

Analog-switching MOS FET Relays for High Switching Currents, with Dielectric Strength of 2.5 kVAC between I/O.



- New 2-channel model included in the 60-V load voltage series.
- Switches minute analog signals.
- Dielectric strength of 2,500 Vrms between I/O.
- Surface-mounting models included in series.

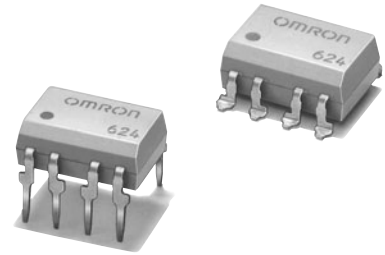

Note: The actual product is marked differently from the image shown here.

RoHS compliant

Application Examples

- Test & Measurement equipment
- Security equipment

Terminal Arrangement/Internal Connections

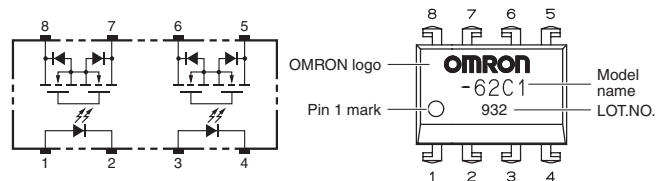

List of Models

Package type	Contact form	Terminals	Load voltage (peak value) *	Model	Minimum package quantity	
					Number per tube	Number per tape and reel
DIP8	2a (DPST-NO)	PCB Terminals	60 V	G3VM-62C1	50	-
		Surface-mounting Terminals		G3VM-62F1		
				G3VM-62F1(TR)	-	1,500

* The AC peak and DC value are given for the load voltage.

Absolute Maximum Ratings (Ta = 25°C)

Item	Symbol	Rating	Unit	Measurement conditions	
Input	LED forward current	IF	50	mA	
	Repetitive peak LED forward current	IFP	1	A	100 μs pulses, 100 pps
	LED forward current reduction rate	ΔIF/°C	-0.5	mA/°C	Ta ≥ 25°C
	LED reverse voltage	VR	5	V	
Output	Load voltage (AC peak/DC)	V _{OFF}	60	V	
	Continuous load current (AC peak/DC)	Io	500	mA	
	ON current reduction rate	ΔIo/°C	-5.0	mA/°C	Ta ≥ 25°C
	Connection temperature	TJ	125	°C	
Dielectric strength between I/O (See note 1.)	V _{I-O}	2500	Vrms	AC for 1 min	
Ambient operating temperature	Ta	-40 to +85	°C	With no icing or condensation	
Ambient storage temperature	Tstg	-55 to +125	°C	With no icing or condensation	
Soldering temperature	-	260	°C	10 s	

Note: 1. The dielectric strength between the input and output was checked by applying voltage between all pins as a group on the LED side and all pins as a group on the light-receiving side.

Electrical Characteristics (Ta = 25°C)

Item	Symbol	Minimum	Typical	Maximum	Unit	Measurement conditions	
Input	LED forward voltage	V _F	1.0	1.15	1.3	V	IF = 10 mA
	Reverse current	I _R	-	-	10	μA	VR = 5 V
	Capacity between terminals	C _T	-	30	-	pF	V = 0, f = 1 MHz
	Trigger LED forward current	I _{FT}	-	1.6	3	mA	Io = 500 mA
Output	Maximum resistance with output ON	R _{ON}	-	1.0	2.0	Ω	IF = 5 mA, Io = 500 mA
	Current leakage when the relay is open	I _{LEAK}	-	-	1.0	μA	V _{OFF} = 60 V
	Capacity between terminals	C _{OFF}	-	130	-	pF	V = 0, f = 1 MHz
	Capacity between I/O terminals	C _{I-O}	-	0.8	-	pF	f = 1 MHz, Vs = 0 V
Insulation resistance between I/O terminals	R _{I-O}	1000	-	-	MΩ	V _{I-O} = 500 VDC, RoH ≤ 60%	
Turn-ON time	t _{ON}	-	0.8	2.0	ms	IF = 5 mA, RL = 200 Ω, VDD = 20 V (See note 2.)	
Turn-OFF time	t _{OFF}	-	0.1	0.5	ms		

Note: 2. Turn-ON and Turn-OFF Times

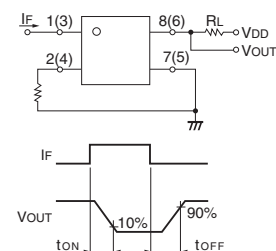

Recommended Operating Conditions

Use the G3VM under the following conditions so that the Relay will operate properly.

Item	Symbol	Minimum	Typical	Maximum	Unit
Load voltage (AC peak/DC)	V _{DD}	-	-	48	V
Operating LED forward current	I _F	5	7.5	25	mA
Continuous load current (AC peak/DC)	I _O	-	-	500	mA
Ambient operating temperature	T _a	-20	-	65	°C

Engineering Data

LED forward current vs. Ambient temperature

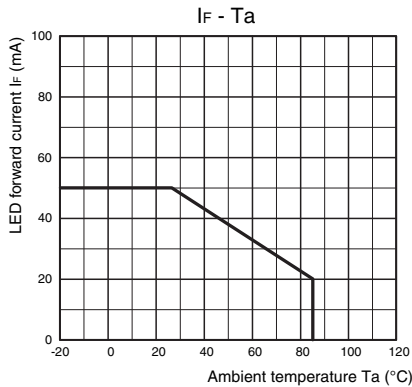

Continuous load current vs. Ambient temperature

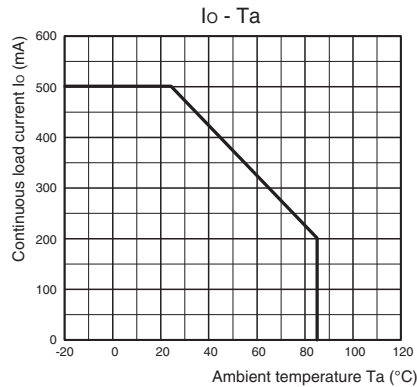

LED forward current vs. LED forward voltage

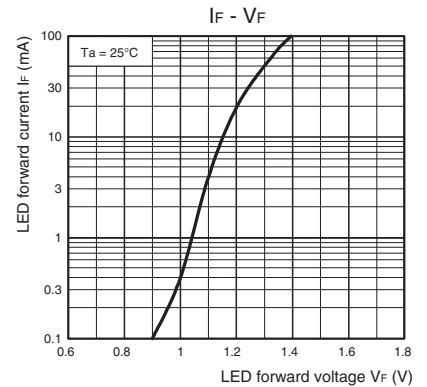

Continuous load current vs. On-state voltage

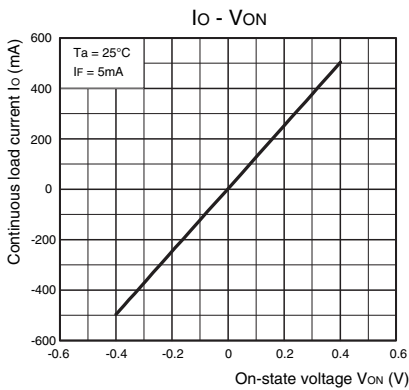

On-state resistance vs. Ambient temperature

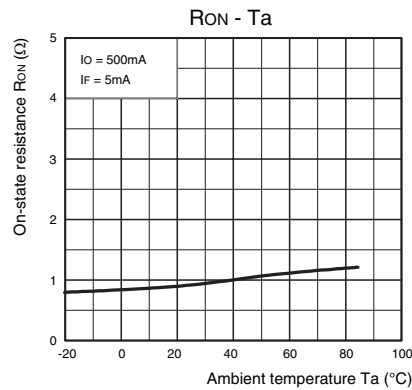

Trigger LED forward current vs. Ambient temperature

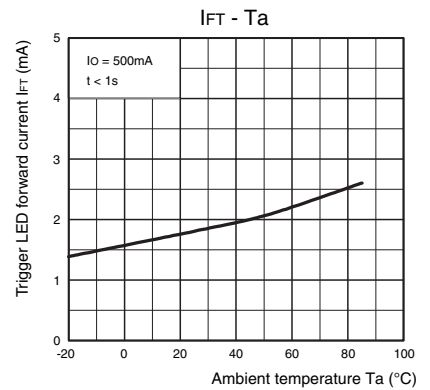

Turn ON, Turn OFF time vs. LED forward current

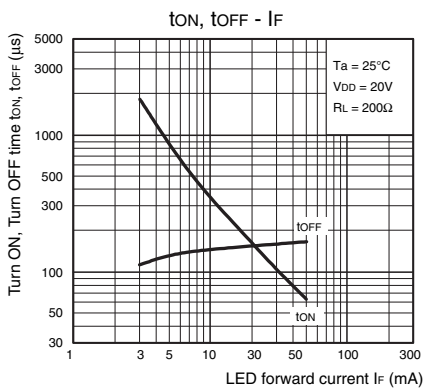

Turn ON, Turn OFF time vs. Ambient temperature

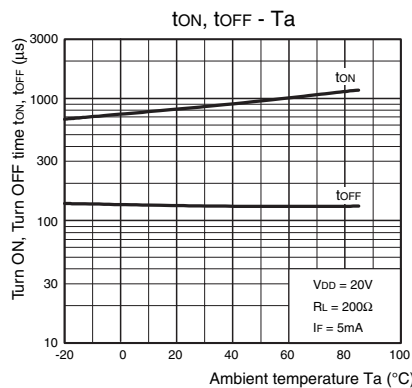

Current leakage vs. Ambient temperature

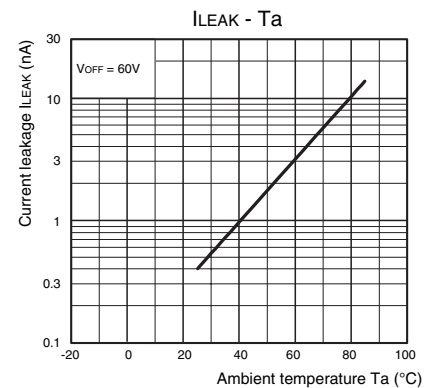

Safety Precautions

- Refer to "Common Precautions" for all G3VM models.

■ Appearance

DIP (Dual Inline Package)

DIP8

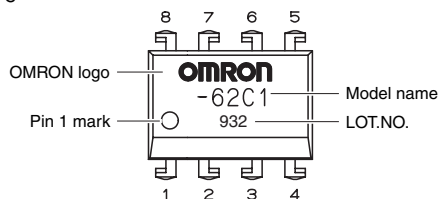

Note: The actual product is marked differently from the image shown here.

■ Dimensions

(Unit:mm)



PCB Terminals

Weight: 0.54 g

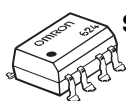
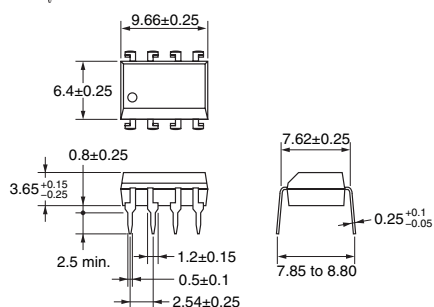

Surface-mounting Terminals

Weight: 0.54 g

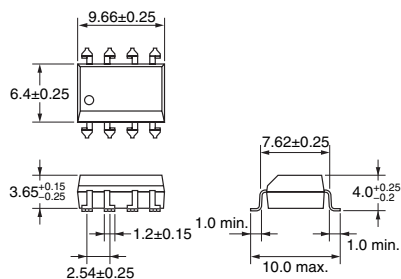

PCB Dimensions (BOTTOM VIEW)

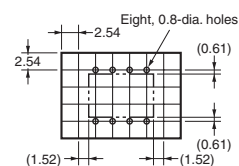

Actual Mounting Pad Dimensions

(Recommended Value, TOP VIEW)

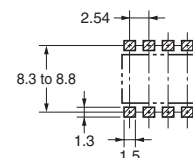

Note: The actual product is marked differently from the image shown here.

- Application examples provided in this document are for reference only. In actual applications, confirm equipment functions and safety before using the product.
- Consult your OMRON representative before using the product under conditions which are not described in the manual or applying the product to nuclear control systems, railroad systems, aviation systems, vehicles, combustion systems, medical equipment, amusement machines, safety equipment, and other systems or equipment that may have a serious influence on lives and property if used improperly. Make sure that the ratings and performance characteristics of the product provide a margin of safety for the system or equipment, and be sure to provide the system or equipment with double safety mechanisms.

Note: Do not use this document to operate the Unit.

OMRON Corporation

ELECTRONIC AND MECHANICAL COMPONENTS COMPANY

Contact: www.omron.com/ecb

Cat. No. **K145-E1-01**
0412(0412)(O)

Mouser Electronics

Authorized Distributor

Click to View Pricing, Inventory, Delivery & Lifecycle Information:

Omron:

[G3VM-62F1](#) [G3VM-62F1\(TR\)](#) [G3VM-62C1](#)