

PLEASE CHECK WWW.MOLEX.COM FOR LATEST PART INFORMATION

Part Number: [51281-1094](#)
Status: **Active**
Overview: FFC-FPC (SMT)
Description: 0.50mm Pitch FFC/FPC Connector, SMT, Right Angle, Non-ZIF, Dual Contact Style, 1.20mm Mated Height, 10 Circuits, Lead-Free, Gold (Au) Plating

Documents:

[3D Model](#) [Packaging Specification SPK-51281-001 \(PDF\)](#)
[Drawing \(PDF\)](#) [RoHS Certificate of Compliance \(PDF\)](#)
[Product Specification PS-51281-003 \(PDF\)](#)

General

Product Family FFC/FPC Connectors
 Series [51281](#)
 Overview [FFC-FPC \(SMT\)](#)
 Product Name N/A
 UPC 822348700066

Physical

Circuits (Loaded) 10
 Color - Resin Natural
 Contact Position Dual
 Durability (mating cycles max) 20
 Entry Angle 90° Angle
 Mated Height 1.20mm
 Material - Metal Phosphor Bronze
 Material - Plating Mating Gold
 Material - Plating Termination Tin
 Net Weight 70.780/mg
 Number of Rows 1
 Orientation Right Angle
 PCB Locator No
 PCB Retention Yes
 Packaging Type Embossed Tape on Reel
 Pitch - Mating Interface 0.50mm
 Plating min - Mating 0.102µm
 Plating min - Termination 1.016µm
 Polarized to PCB Yes
 Stackable No
 Surface Mount Compatible (SMC) N/A
 Temperature Range - Operating -20°C to +85°C
 Termination Interface: Style Surface Mount
 Wire/Cable Type FFC/FPC

Electrical

Current - Maximum per Contact 0.5A
 Voltage - Maximum 50V

Material Info

Reference - Drawing Numbers

Packaging Specification SPK-51281-001
 Product Specification PS-51281-003, RPS-51281-016, RPS-51281-017, RPS-51281-018, RPS-51281-019, RPS-51281-021, RPS-51281-022
 Sales Drawing SD-51281-011, SD-51281-012

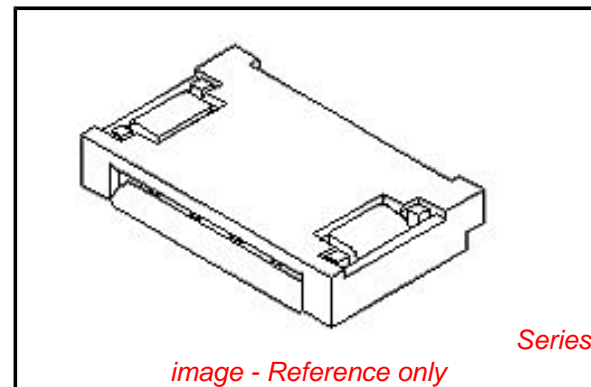

image - Reference only

EU RoHS

**ELV and RoHS
 Compliant**
**REACH SVHC
 Contains SVHC: No
 Low-Halogen Status
 Low-Halogen**

China RoHS



**Need more information on product
 environmental compliance?**

Email productcompliance@molex.com
 For a multiple part number RoHS Certificate of Compliance, [click here](#)

Please visit the [Contact Us](#) section for any non-product compliance questions.

Search Parts in this Series

51281Series

This document was generated on 02/04/2013

PLEASE CHECK WWW.MOLEX.COM FOR LATEST PART INFORMATION