

**Panasonic**  
ideas for life

**GU (General Use) Type SOP  
Series 1-Channel (Form A)  
High Capacity 4-Pin Type**

**PhotoMOS  
RELAYS**



mm inch

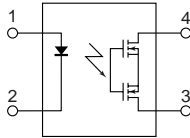

## FEATURES

1. Greatly increased load current in the same, miniature, 4-pin SO package.
2. Greatly improved specs allow you to use this in place of mercury and mechanical relays.

## TYPICAL APPLICATIONS

- Measuring instrument market
- Security market  
(use in I/O for alarm and security devices, etc.)

## TYPES

Type	Output rating*		Part No.		Packing quantity
	Load voltage	Load current	Picked from the 1/2-pin side	Picked from the 3/4-pin side	
			1 Form A	1 Form A	
AC/DC type	60 V	1.0 A	AQY212GSX	AQY212GSZ	Tape and reel: 1,000 pcs.

\* Indicate the peak AC and DC values.

Notes: (1) Tape package is the standard packing style. Also available in tube. (Part No. suffix "X" or "Z" is not needed when ordering; Tube: 100 pcs.; Case: 2,000 pcs.)

- (2) For space reasons, the initial letters of the product number "AQY" and "S" are omitted on the product seal.  
The package type indicator "X" and "Z" are omitted from the seal. (Ex. the label for product number AQY212GS is 212G).

## RATING

1. Absolute maximum ratings (Ambient temperature: 25°C 77°F)

Item		Symbol	AQY212GS	Remarks
Input	LED forward current	$I_F$	50 mA	
	LED reverse voltage	$V_R$	5 V	
	Peak forward current	$I_{FP}$	1 A	f = 100 Hz, Duty factor = 0.1%
	Power dissipation	$P_{in}$	75 mW	
Output	Load voltage (peak AC)	$V_L$	60 V	
	Continuous load current (peak AC)	$I_L$	1.0 A	
	Peak load current	$I_{peak}$	3.0 A	100ms (1 shot), $V_L = DC$
	Power dissipation	$P_{out}$	300 mW	
Total power dissipation		$P_T$	350 mW	
I/O isolation voltage		$V_{iso}$	1,500 V AC	
Temperature limits	Operating	$T_{opr}$	-40°C to +85°C -40°F to +185°F	Non-condensing at low temperatures
	Storage	$T_{stg}$	-40°C to +100°C -40°F to +212°F	

# AQY212GS

## 2. Electrical characteristics (Ambient temperature: 25°C 77°F)

Item		Symbol	AQY212GS	Condition	
Input	LED operate current	Typical	1.1 mA	$I_L = 100\text{mA}$	
		Maximum	3 mA		
	LED turn off current	Minimum	0.3 mA	$I_L = 100\text{mA}$	
		Typical	1.0 mA		
LED dropout voltage	Typical	1.14 V (1.32 V at $I_F = 50\text{ mA}$ )		$I_F = 5\text{ mA}$	
	Maximum	1.5 V			
Output	On resistance	Typical	0.34 $\Omega$	$I_F = 5\text{ mA}$ $I_L = \text{Max.}$ Within 1 s on time	
		Maximum	0.7 $\Omega$		
	Off state leakage current	Maximum	$I_{\text{Leak}}$	1 $\mu\text{A}$	$I_F = 0$ $V_L = \text{Max.}$
Transfer characteristics	Turn on time*	Typical	1.3 ms	$I_F = 5\text{ mA}$ $I_L = 100\text{ mA}$ $V_L = 10\text{ V}$	
		Maximum	5.0 ms		
	Turn off time*	Typical	0.1 ms	$I_F = 5\text{ mA}$ $I_L = 100\text{ mA}$ $V_L = 10\text{ V}$	
		Maximum	0.5 ms		
	I/O capacitance	Typical	$C_{\text{iso}}$	0.8 pF	$f = 1\text{ MHz}$ $V_B = 0$
		Maximum		1.5 pF	
Initial I/O isolation resistance	Minimum	$R_{\text{iso}}$	1,000 M $\Omega$	500 V DC	

Note: Recommendable LED forward current  $I_F = 5$  to 10 mA.

For type of connection, see Page 4.

\*Turn on/Turn off time

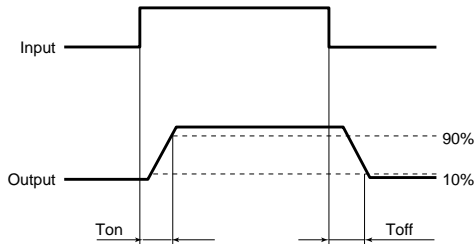

## REFERENCE DATA

### 1. Load current vs. ambient temperature characteristics

Allowable ambient temperature:  $-40^\circ\text{C}$  to  $+85^\circ\text{C}$   
 $-40^\circ\text{F}$  to  $+185^\circ\text{F}$

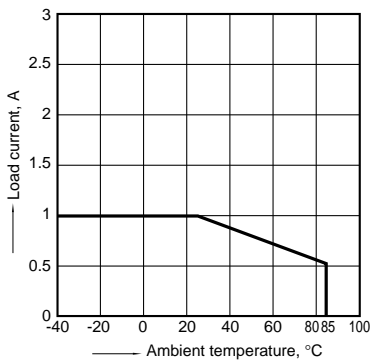

### 2. On resistance vs. ambient temperature characteristics

Measured portion: between terminals 3 and 4;  
LED current: 5 mA; Load voltage: Max. (DC)  
Continuous load current: Max. (DC)

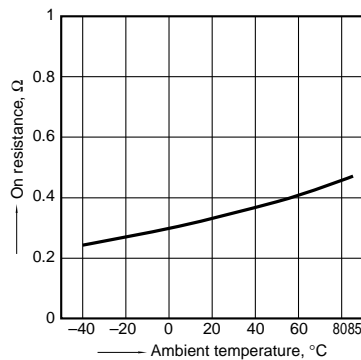

### 3. Turn on time vs. ambient temperature characteristics

LED current: 5 mA; Load voltage: 10 V (DC);  
Continuous load current: 100 mA (DC)

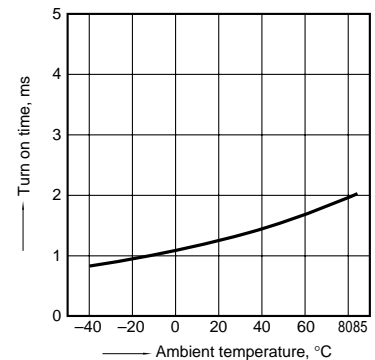

4. Turn off time vs. ambient temperature characteristics

LED current: 5 mA; Load voltage: 10 V (DC);  
Continuous load current: 100 mA (DC)

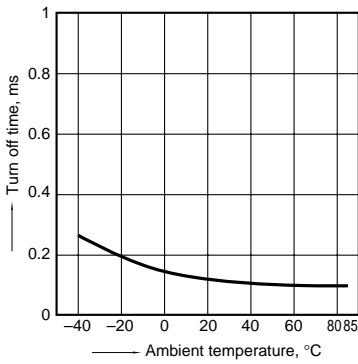

5. LED operate current vs. ambient temperature characteristics

Load voltage: 10 V (DC);  
Continuous load current: 100mA (DC)

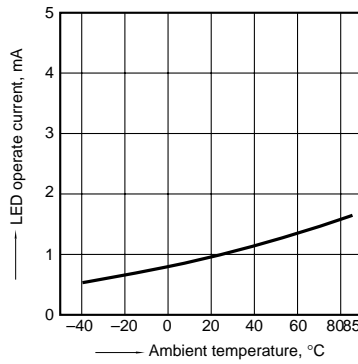

6. LED turn off current vs. ambient temperature characteristics

Load voltage: 10 V (DC);  
Continuous load current: 100mA (DC)

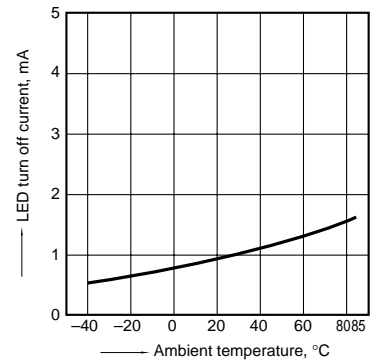

7. LED dropout voltage vs. ambient temperature characteristics

LED current: 5 to 50 mA

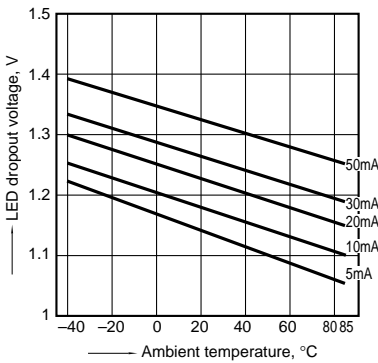

8. Voltage vs. current characteristics of output at MOS portion

Measured portion: between terminals 3 and 4;  
Ambient temperature: 25°C 77°F

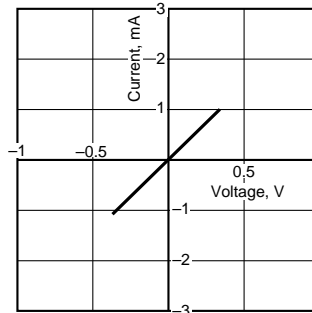

9. Off state leakage current

Measured portion: between terminals 3 and 4;  
Ambient temperature: 25°C 77°F

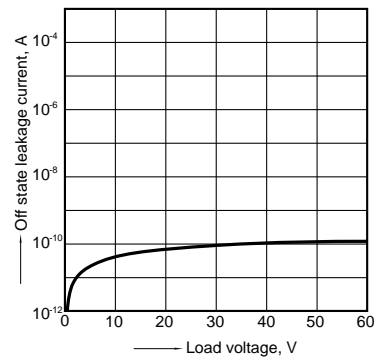

10. LED forward current vs. turn on time characteristics

Measured portion: between terminals 3 and 4;  
Load voltage: 10 V (DC);  
Continuous load current: 100 mA (DC);  
Ambient temperature: 25°C 77°F

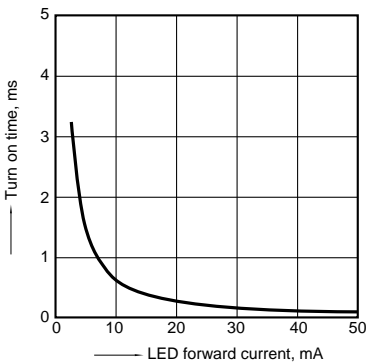

11. LED forward current vs. turn off time characteristics

Measured portion: between terminals 3 and 4;  
Load voltage: 10 V (DC);  
Continuous load current: 100 mA (DC);  
Ambient temperature: 25°C 77°F

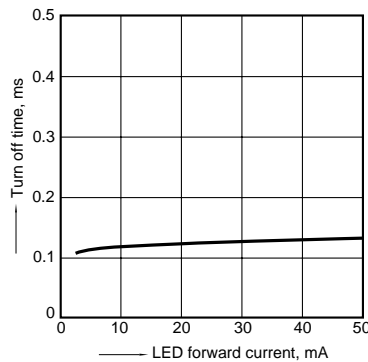

12. Applied voltage vs. output capacitance characteristics

Measured portion: between terminals 3 and 4;  
Frequency: 1 MHz;  
Ambient temperature: 25°C 77°F

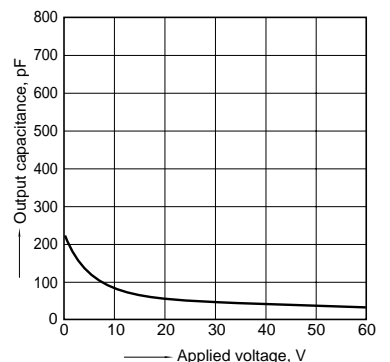

# AQY212GS

## DIMENSIONS

mm inch

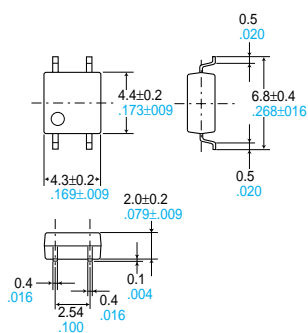

Terminal thickness = 0.15.006  
 General tolerance: ±0.1 ±.004

Recommended mounting pad  
(TOP VIEW)

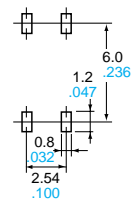

Tolerance: ±0.1 ±.004

## SCHEMATIC AND WIRING DIAGRAMS

Notes: E1: Power source at input side; I<sub>F</sub>: LED forward current; V<sub>L</sub>: Load voltage; I<sub>L</sub>: Load current;

Schematic	Output configuration	Load	Connection	Wiring diagram
	1a	AC/DC	—	

# Cautions for Use

## SAFETY WARNINGS

- Do not use the product under conditions that exceed the range of its specifications. It may cause overheating, smoke, or fire.
- Do not touch the recharging unit while the power is on. There is a danger of

electrical shock. Be sure to turn off the power when performing mounting, maintenance, or repair operations on the relay (including connecting parts such as the terminal board and socket).

- Check the connection diagrams in the catalog and be sure to connect the terminals correctly. Erroneous connections could lead to unexpected operating errors, overheating, or fire.

## NOTES

### 1. Short across terminals

Do not short circuit between terminals when relay is energized. There is possibility of breaking the internal IC.

### 2. Surge voltages at the input

If reverse surge voltages are present at the input terminals, connect a diode in reverse parallel across the input terminals and keep the reverse voltages below the reverse breakdown voltage.

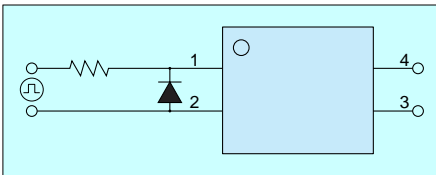

### 3. Recommended LED forward current (I<sub>F</sub>)

It is recommended that the LED forward current (I<sub>F</sub>) be kept at 5mA.

### 4. Ripple in the input power supply

If ripple is present in the input power supply, observe the following:

- 1) For LED operate current at E<sub>min</sub>, maintain the value mentioned in the table of "Note 3. Recommended LED forward current (I<sub>F</sub>)."

- 2) Keep the LED operate current at 50 mA or less at E<sub>max</sub>.

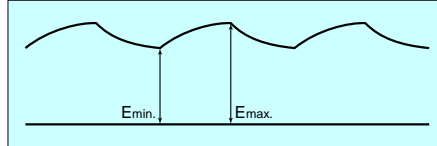

### 5. Output spike voltages

- 1) If an inductive load generates spike voltages which exceed the absolute maximum rating, the spike voltage must be limited.

Typical circuits are shown below.

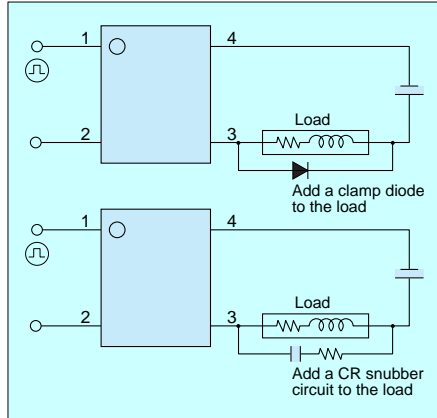

- 2) If spike voltages generated at the load are limited with a clamp diode and the circuit wires are long, spike voltages will occur by inductance. Keep wires as short as possible to minimize inductance.

### 6. Cleaning solvents compatibility

Dip cleaning with an organic solvent is recommended for removal of solder flux, dust, etc. Select a cleaning solvent from the following table. If ultrasonic cleaning is used, the severity of factors such as frequency, output power and cleaning solvent selected may cause loose wires and other defects. Make sure these conditions are correct before use. For details, please consult us.

Cleaning solvent		Compatibility (○: Yes X: No)
Chlorine-base	<ul style="list-style-type: none"> <li>• Trichlene</li> <li>• Chloroethylene</li> </ul>	○
Aqueous	<ul style="list-style-type: none"> <li>• Indusco</li> <li>• Hollis</li> <li>• Lonco Terg</li> </ul>	○
Alcohol-base	<ul style="list-style-type: none"> <li>• IPA</li> <li>• Ethanol</li> </ul>	○
Others	<ul style="list-style-type: none"> <li>• Thinner</li> <li>• Gasoline</li> </ul>	X

## 7. Soldering

When soldering this terminals, the following conditions are recommended.

- (1) IR (Infrared reflow) soldering method

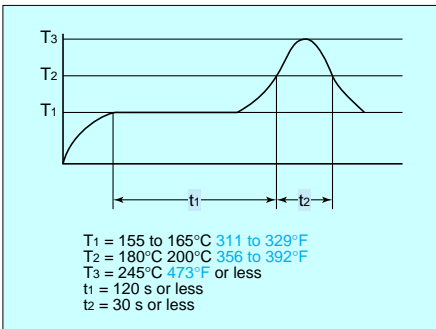

- (2) Vapor phase soldering method

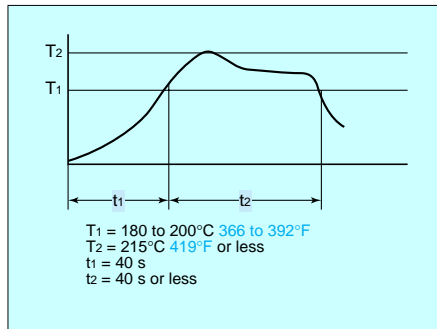

- (3) Double wave soldering method

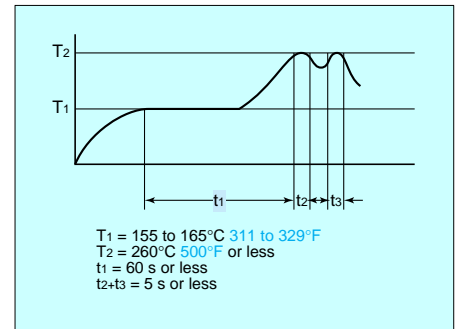

- (4) Soldering iron method

Tip temperature: 280 to 300°C 536 to 572°F

Wattage: 30 to 60 W

Soldering time: within 5 s

- (5) Others

Check mounting conditions before using other soldering methods (hot-air, hot plate, pulse heater, etc.)

- The temperature profile indicates the temperature of the soldered terminal on the surface of the PC board. The ambient

temperature may increase excessively. Check the temperature under mounting conditions.

- The conditions for the infrared reflow soldering apply when preheating using the VPS method.

# AQY212GS

## 8. The following shows the packaging format

### 1) Tape and reel

mm inch

Type	Tape dimensions	Dimensions of paper tape reel
SO package 4-pin type	<p>(1) When picked from 1/2-pin side: Part No. AQY○○○SX (Shown above) (2) When picked from 3/4-pin side: Part No. AQY○○○SZ</p>	

### 2) Tube

(1) Devices are packaged in a tube so pin No. 1 is on the stopper B side. Observe correct orientation when mounting them on PC boards.

(SOP type)

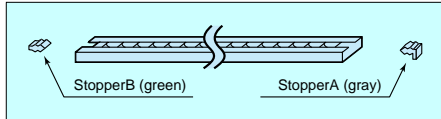

### 2) Storage

PhotoMOS relays implemented in SO packages are sensitive to moisture and come in sealed moisture-proof packages. Observe the following cautions on storage.

- After the moisture-proof package is unsealed, take the devices out of storage as soon as possible (within 1 month at the most).

- If the devices are to be left in storage for a considerable period after the moisture-proof package has been unsealed, it is recommended to keep them in another moisture-proof bag containing silica gel (within 3 months at the most).

### 9. Transportation and storage

1) Extreme vibration during transport will warp the lead or damage the relay. Handle the outer and inner boxes with care.

2) Storage under extreme conditions will cause soldering degradation, external appearance defects, and deterioration of the characteristics. The following storage conditions are recommended:

- Temperature: 0 to 45°C 32 to 113°F
- Humidity: Less than 70% R.H.
- Atmosphere: No harmful gasses such as sulfurous acid gas, minimal dust.