

## Reflective Optical Sensor with Transistor Output

### Description

The CNY70 is a reflective sensor that includes an infrared emitter and phototransistor in a leaded package which blocks visible light.

### Features

- Package type: Leaded
- Detector type: Phototransistor
- Dimensions: L 7 mm x W 7 mm x H 6 mm
- Peak operating distance: < 0.5 mm
- Operating range: 0 mm to 4.5 mm
- Typical output current under test:  $I_C = 1 \text{ mA}$
- Daylight blocking filter
- Emitter wavelength 950 nm
- Lead (Pb)-free soldering released
- Lead (Pb)-free component in accordance to RoHS 2002/95/EC and WEEE 2002/96/EC
- Minimum order quantity 4000 pcs in tubes, 80 pcs/tube

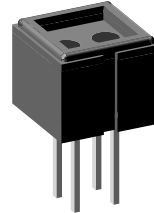

19158

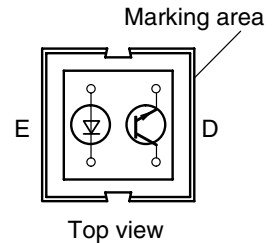

Top view

### Applications

Optoelectronic scanning and switching devices i.e., index sensing, coded disk scanning etc. (optoelectronic encoder assemblies).

### Absolute Maximum Ratings

$T_{amb} = 25 \text{ }^\circ\text{C}$ , unless otherwise specified

### Coupler

Parameter	Test condition	Symbol	Value	Unit
Total power dissipation	$T_{amb} \leq 25 \text{ }^\circ\text{C}$	$P_{tot}$	200	mW
Ambient temperature range		$T_{amb}$	- 40 to + 85	$^\circ\text{C}$
Storage temperature range		$T_{stg}$	- 40 to + 100	$^\circ\text{C}$
Soldering temperature	Distance to case 2 mm, $t \leq 5 \text{ s}$	$T_{sd}$	260	$^\circ\text{C}$

### Input (Emitter)

Parameter	Test condition	Symbol	Value	Unit
Reverse voltage		$V_R$	5	V
Forward current		$I_F$	50	mA
Forward surge current	$t_p \leq 10 \text{ } \mu\text{s}$	$I_{FSM}$	3	A
Power dissipation	$T_{amb} \leq 25 \text{ }^\circ\text{C}$	$P_V$	100	mW
Junction temperature		$T_j$	100	$^\circ\text{C}$

## Output (Detector)

Parameter	Test condition	Symbol	Value	Unit
Collector emitter voltage		$V_{CEO}$	32	V
Emitter collector voltage		$V_{ECO}$	7	V
Collector current		$I_C$	50	mA
Power dissipation	$T_{amb} \leq 25\text{ }^\circ\text{C}$	$P_V$	100	mW
Junction temperature		$T_j$	100	$^\circ\text{C}$

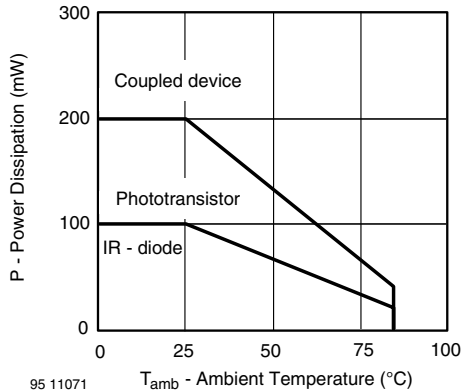

Figure 1. Power Dissipation Limit vs. Ambient Temperature

## Electrical Characteristics

$T_{amb} = 25\text{ }^\circ\text{C}$ , unless otherwise specified

### Coupler

Parameter	Test condition	Symbol	Min	Typ.	Max	Unit
Collector current	$V_{CE} = 5\text{ V}$ , $I_F = 20\text{ mA}$ , $d = 0.3\text{ mm}$ (figure 2)	$I_C^{1)}$	0.3	1.0		mA
Cross talk current	$V_{CE} = 5\text{ V}$ , $I_F = 20\text{ mA}$ (figure 1)	$I_{CX}^{2)}$			600	nA
Collector emitter saturation voltage	$I_F = 20\text{ mA}$ , $I_C = 0.1\text{ mA}$ , $d = 0.3\text{ mm}$ (figure 2)	$V_{CEsat}^{1)}$			0.3	V

<sup>1)</sup> Measured with the 'Kodak neutral test card', white side with 90 % diffuse reflectance

<sup>2)</sup> Measured without reflecting medium

### Input (Emitter)

Parameter	Test condition	Symbol	Min	Typ.	Max	Unit
Forward voltage	$I_F = 50\text{ mA}$	$V_F$		1.25	1.6	V
Radiant intensity	$I_F = 50\text{ mA}$ , $t_P = 20\text{ ms}$	$I_e$			7.5	mW/sr
Peak wavelength	$I_F = 100\text{ mA}$	$\lambda_P$	940			nm
Virtual source diameter	Method: 63 % encircled energy	$\emptyset$		1.2		mm

### Output (Detector)

Parameter	Test condition	Symbol	Min	Typ.	Max	Unit
Collector emitter voltage	$I_C = 1\text{ mA}$	$V_{CEO}$	32			V
Emitter collector voltage	$I_E = 100\text{ }\mu\text{A}$	$V_{ECO}$	5			V
Collector dark current	$V_{CE} = 20\text{ V}$ , $I_f = 0$ , $E = 0$	$I_{CEO}$			200	nA

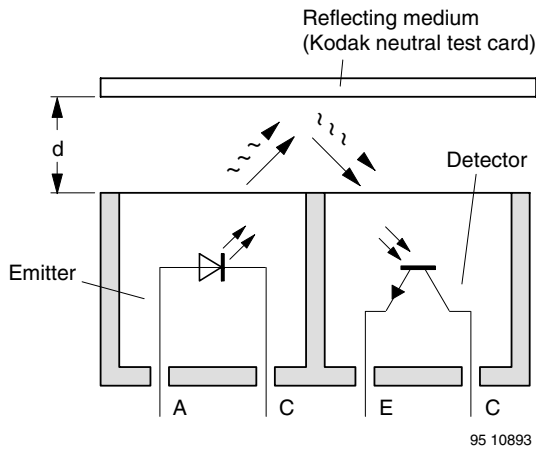

Figure 2. Test Condition

## Typical Characteristics

$T_{amb} = 25\text{ }^{\circ}\text{C}$  unless otherwise specified

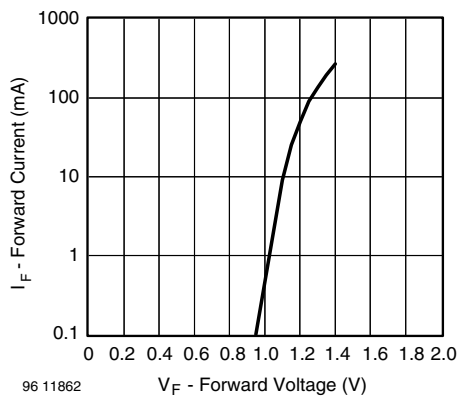

Figure 3. Forward Current vs. Forward Voltage

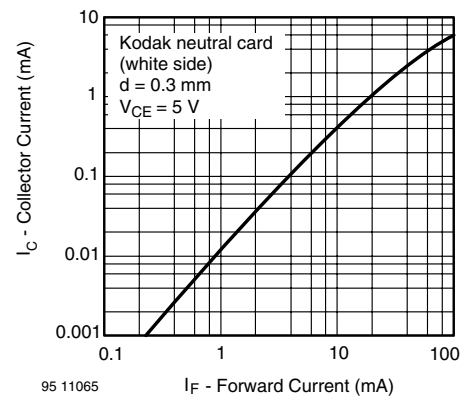

Figure 5. Collector Current vs. Forward Current

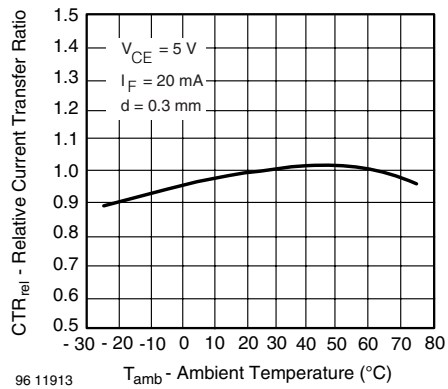

Figure 4. Relative Current Transfer Ratio vs. Ambient Temperature

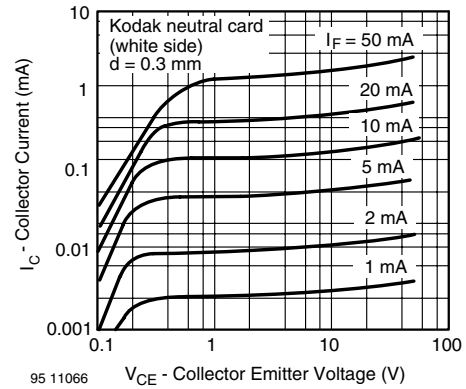

Figure 6. Collector Current vs. Collector Emitter Voltage

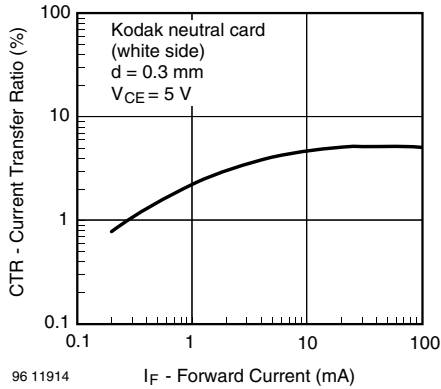

Figure 7. Current Transfer Ratio vs. Forward Current

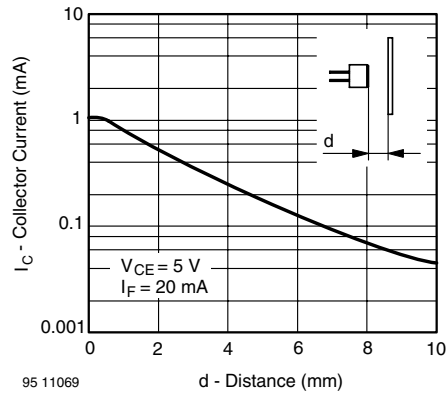

Figure 9. Collector Current vs. Distance

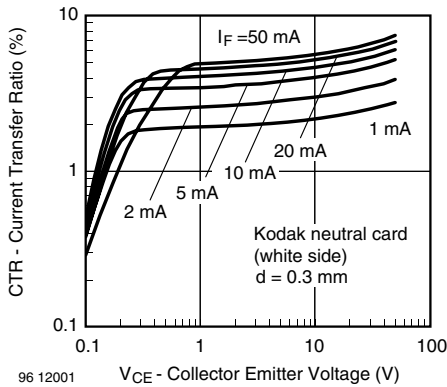

Figure 8. Current Transfer Ratio vs. Collector Emitter Voltage

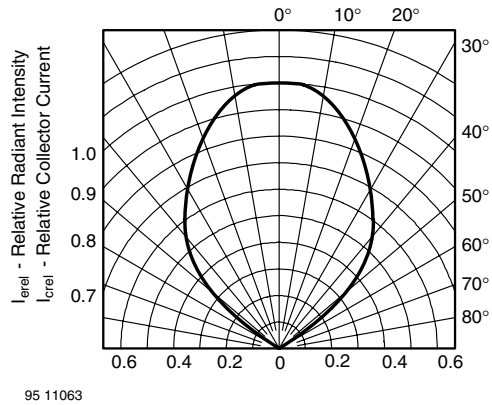

Figure 10. Relative Radiant Intensity/Collector Current vs. Angular Displacement

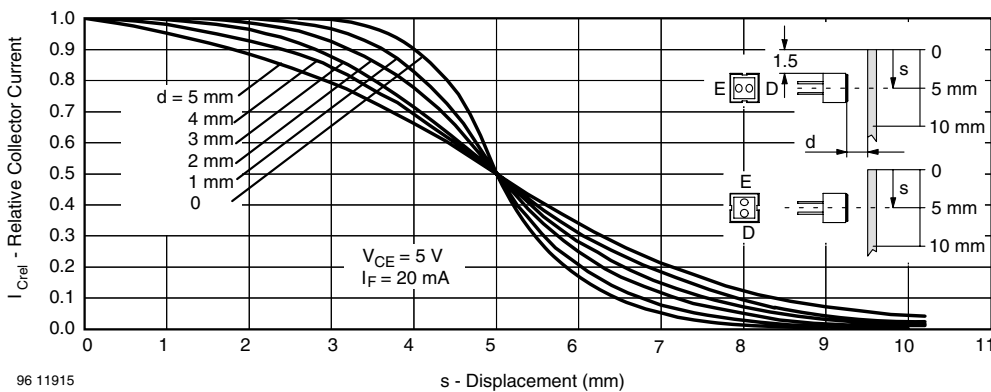
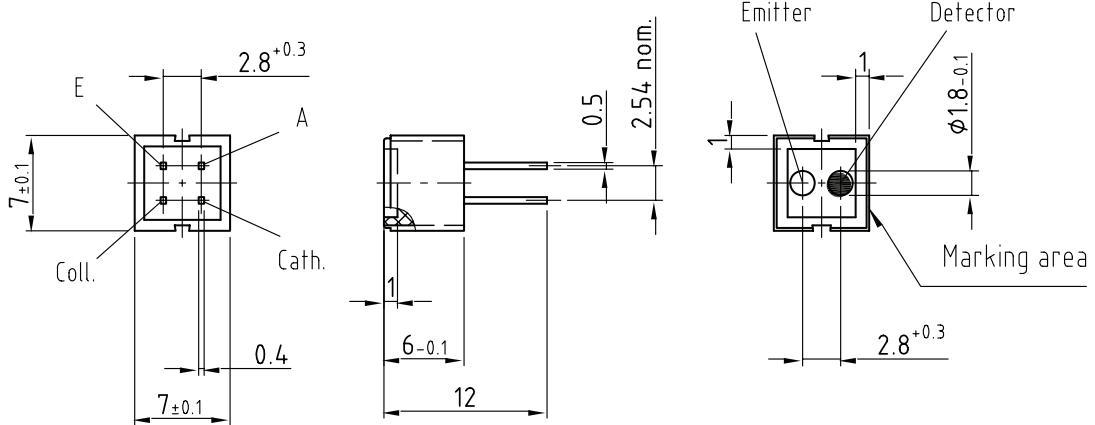
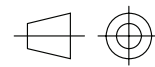

Figure 11. Relative Collector Current vs. Displacement

## Package Dimensions



weight: ca. 0.70g  
All dimensions in mm



technical drawings  
according to DIN  
specifications

Drawing-No.: 6.544-5062.01-4  
Issue: 6; 03.05.06  
95 11345

Drawing refers to following types: CNY 70

## Tube Dimensions

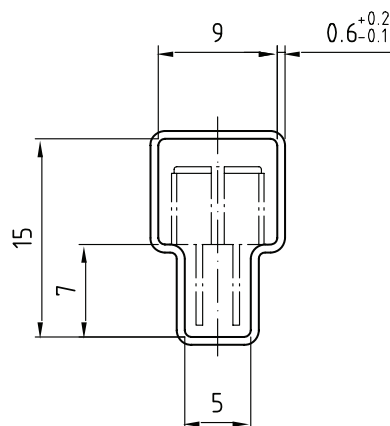

With rubber stopper  
Tolerance:  $\pm 0.5$ mm  
Length:  $575 \pm 1$ mm  
All dimensions in mm

Drawing-No.: 9.700-5097.01-4  
Issue: 1; 25.02.00  
20291

### Ozone Depleting Substances Policy Statement

It is the policy of Vishay Semiconductor GmbH to

1. Meet all present and future national and international statutory requirements.
2. Regularly and continuously improve the performance of our products, processes, distribution and operating systems with respect to their impact on the health and safety of our employees and the public, as well as their impact on the environment.

It is particular concern to control or eliminate releases of those substances into the atmosphere which are known as ozone depleting substances (ODSs).

The Montreal Protocol (1987) and its London Amendments (1990) intend to severely restrict the use of ODSs and forbid their use within the next ten years. Various national and international initiatives are pressing for an earlier ban on these substances.

Vishay Semiconductor GmbH has been able to use its policy of continuous improvements to eliminate the use of ODSs listed in the following documents.

1. Annex A, B and list of transitional substances of the Montreal Protocol and the London Amendments respectively
2. Class I and II ozone depleting substances in the Clean Air Act Amendments of 1990 by the Environmental Protection Agency (EPA) in the USA
3. Council Decision 88/540/EEC and 91/690/EEC Annex A, B and C (transitional substances) respectively.

Vishay Semiconductor GmbH can certify that our semiconductors are not manufactured with ozone depleting substances and do not contain such substances.

We reserve the right to make changes to improve technical design and may do so without further notice.

Parameters can vary in different applications. All operating parameters must be validated for each customer application by the customer. Should the buyer use Vishay Semiconductors products for any unintended or unauthorized application, the buyer shall indemnify Vishay Semiconductors against all claims, costs, damages, and expenses, arising out of, directly or indirectly, any claim of personal damage, injury or death associated with such unintended or unauthorized use.

Vishay Semiconductor GmbH, P.O.B. 3535, D-74025 Heilbronn, Germany



## Disclaimer

All product specifications and data are subject to change without notice.

Vishay Intertechnology, Inc., its affiliates, agents, and employees, and all persons acting on its or their behalf (collectively, "Vishay"), disclaim any and all liability for any errors, inaccuracies or incompleteness contained herein or in any other disclosure relating to any product.

Vishay disclaims any and all liability arising out of the use or application of any product described herein or of any information provided herein to the maximum extent permitted by law. The product specifications do not expand or otherwise modify Vishay's terms and conditions of purchase, including but not limited to the warranty expressed therein, which apply to these products.

No license, express or implied, by estoppel or otherwise, to any intellectual property rights is granted by this document or by any conduct of Vishay.

The products shown herein are not designed for use in medical, life-saving, or life-sustaining applications unless otherwise expressly indicated. Customers using or selling Vishay products not expressly indicated for use in such applications do so entirely at their own risk and agree to fully indemnify Vishay for any damages arising or resulting from such use or sale. Please contact authorized Vishay personnel to obtain written terms and conditions regarding products designed for such applications.

Product names and markings noted herein may be trademarks of their respective owners.