

EDK, Aluminum Electrolytic, 10 uF, 20%, 63 VDC, -40/+85°C

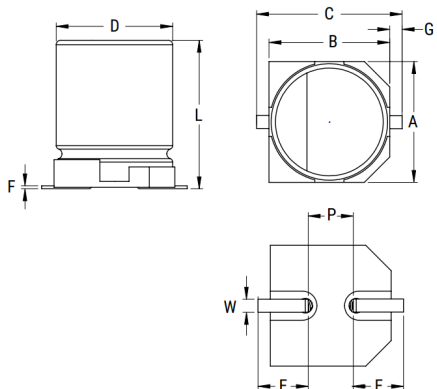

Dimensions

D	6.3mm +/-0.5mm
L	5.4mm +0.25/-0.1mm
W	0.65mm +/-0.1mm
F	0.3mm MAX
A	6.6mm +/-0.2mm
B	6.6mm +/-0.2mm
C	7.8mm MAX
E	2.6mm +/-0.2mm
G	0.35mm +0.15/-0.2mm
P	1.8mm +/-0.2mm

Packaging Specifications

Packaging:	T&R, 380mm
Packaging Quantity:	1000

General Information

Series:	EDK
Dielectric:	Aluminum Electrolytic
Style:	SMD Can
Description:	Surface Mount, Aluminum Electrolytic
RoHS:	Yes
Lead:	V-Chip
AEC-Q200:	No

Specifications

Capacitance:	10 uF
Capacitance Tolerance:	20%
Voltage DC:	63 VDC, 79 VDC (Surge)
Temperature Range:	-40/+85°C
Rated Temperature:	85°C
Life:	2000 Hrs
Dissipation Factor:	18%
Ripple Current:	20 mAmps (120Hz), 27.2 mAmps (120Hz 50C)
Leakage Current:	6.3 uA (2min 20°C)
Impedance Ratio at -25C:	2
Impedance Ratio at -40C:	3
High Temperature Solder:	Yes