

GJM0336C1E9R0BB01#

"#" indicates a package specification code.

Recommended    

< List of part numbers with package codes >
 GJM0336C1E9R0BB01D , GJM0336C1E9R0BB01J , GJM0336C1E9R0BB01C , GJM0336C1E9R0BB01B

Shape

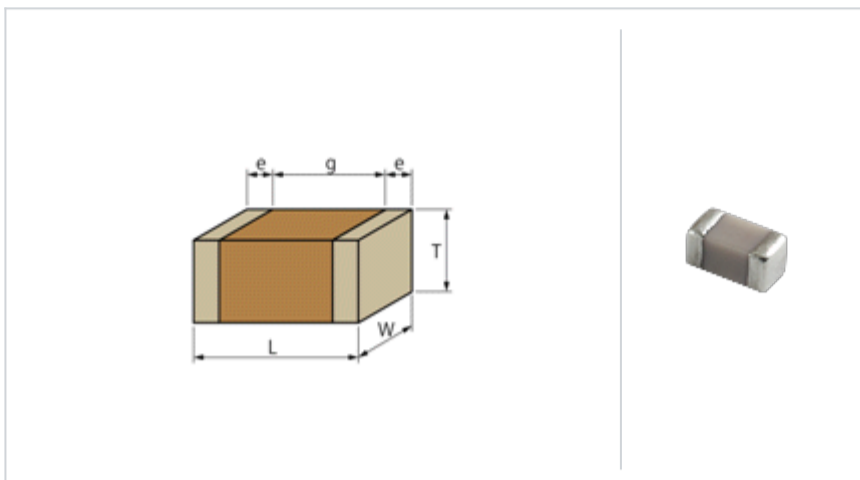

L size	0.6 ± 0.03mm
W size	0.3 ± 0.03mm
T size	0.3 ± 0.03mm
External terminal width e	0.1 to 0.2mm
Distance between external terminals g (Min.)	0.2mm
Size code in mm(inch)	0603 (0201)

References

Packaging	Specifications	Minimum quantity
D	Paper tape (180mm)	15000
J	Paper tape (330mm)	50000
C	Bulk case	50000
B	Packing in bulk	1000

Mass (typ.)	
1 piece	0.33mg
Reel (180mm)	118g

Specifications

Capacitance	9.0pF ± 0.1pF
Rated voltage	25Vdc
Temperature characteristics (complied standard)	C0H(EIA)
Temperature coefficient	0 ± 60ppm/
Temperature range of temperature characteristics	25 to 125
Operating temperature range	-55 to 125

Attention

- 1.This datasheet is downloaded from the website of Murata Manufacturing Co., Ltd. Therefore, it ' s specifications are subject to change or our products in it may be discontinued without advance notice. Please check with our sales representatives or product engineers before ordering.
- 2.This datasheet has only typical specifications because there is no space for detailed specifications. Therefore, please review our product specifications or consult the approval sheet for product specifications before ordering.

▪ Frequency characteristics (ESR, Impedance)

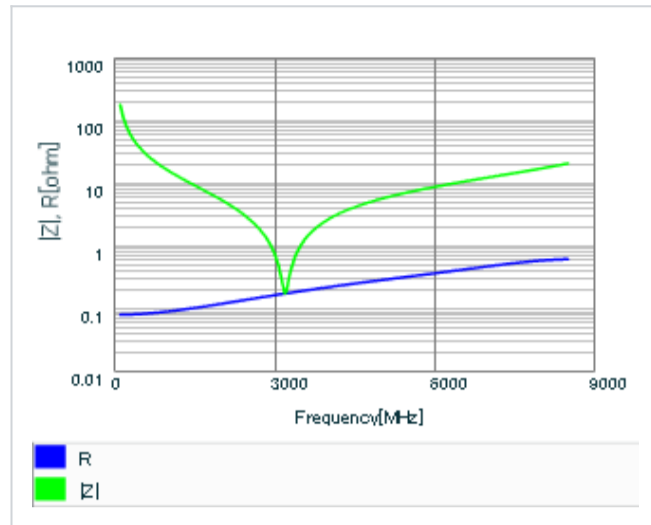

▪ S parameter (Smith chart S11)

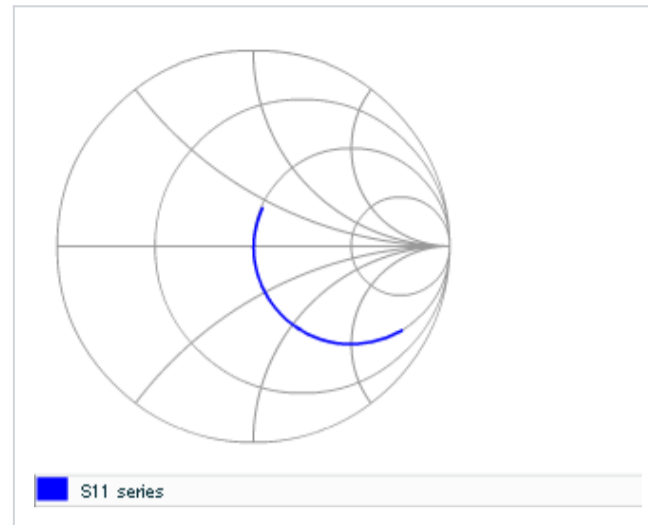

▪ DC bias characteristics

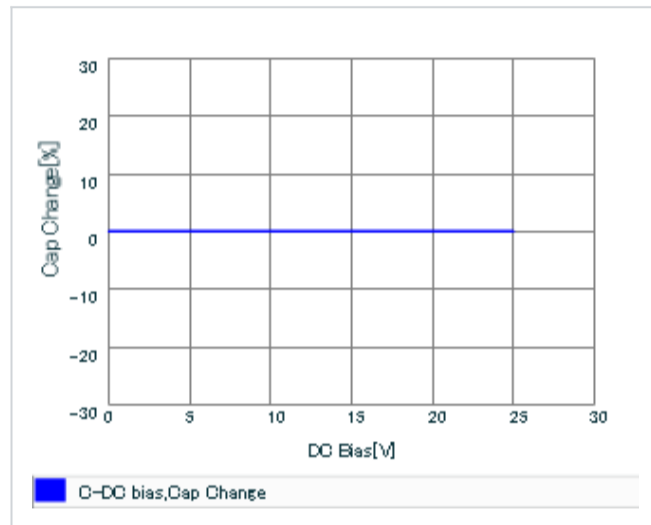

▪ AC voltage characteristics

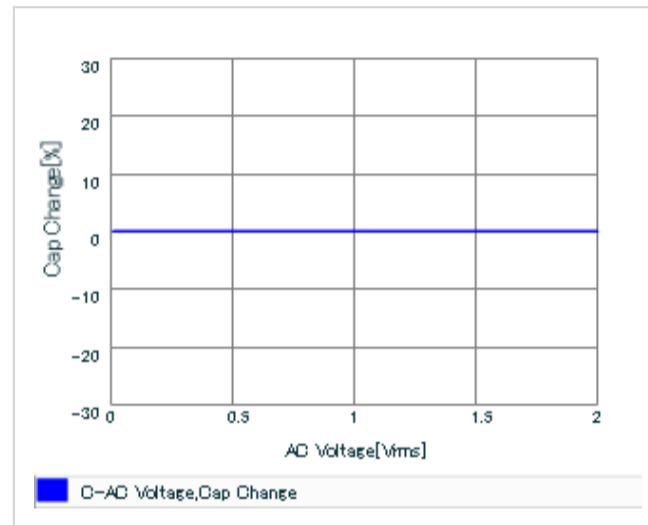

▪ Capacitance - temperature characteristics

