

GRM1555C1H151JA01#

"#" indicates a package specification code.

Recommended



Complies with RoHS

< List of part numbers with package codes >

GRM1555C1H151JA01D , GRM1555C1H151JA01J , GRM1555C1H151JA01C , GRM1555C1H151JA01B

Shape

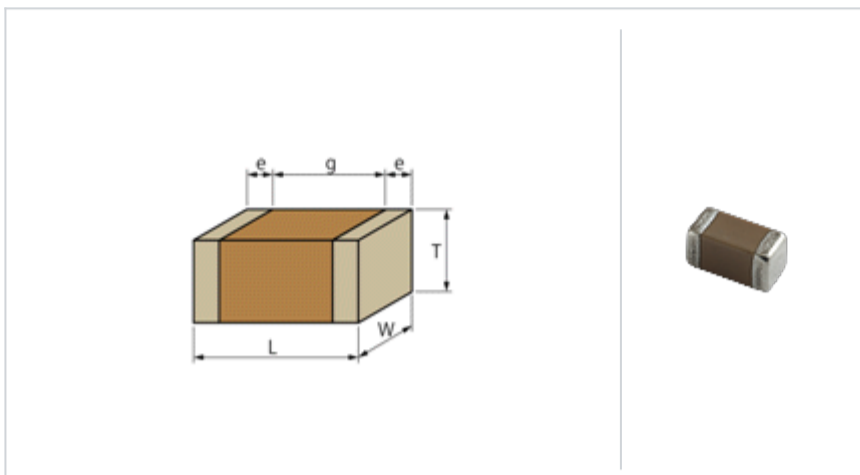

L size	1.0 ± 0.05mm
W size	0.5 ± 0.05mm
T size	0.5 ± 0.05mm
External terminal width e	0.15 to 0.35mm
Distance between external terminals g (Min.)	0.3mm
Size code in mm(inch)	1005 (0402)

References

Packaging	Specifications	Minimum quantity
D	Paper tape (180mm)	10000
J	Paper tape (330mm)	50000
C	Bulk case	50000
B	Packing in bulk	1000

Mass (typ.)	
1 piece	1.6mg
Reel (180mm)	118g

Specifications

Capacitance	150pF ± 5%
Rated voltage	50Vdc
Temperature characteristics (complied standard)	COG(EIA)
Temperature coefficient	0 ± 30ppm/
Temperature range of temperature characteristics	25 to 125
Operating temperature range	-55 to 125

⚠ Attention

- 1.This datasheet is downloaded from the website of Murata Manufacturing Co., Ltd. Therefore, it ' s specifications are subject to change or our products in it may be discontinued without advance notice. Please check with our sales representatives or product engineers before ordering.
- 2.This datasheet has only typical specifications because there is no space for detailed specifications. Therefore, please review our product specifications or consult the approval sheet for product specifications before ordering.

▪ Frequency characteristics (ESR, Impedance)

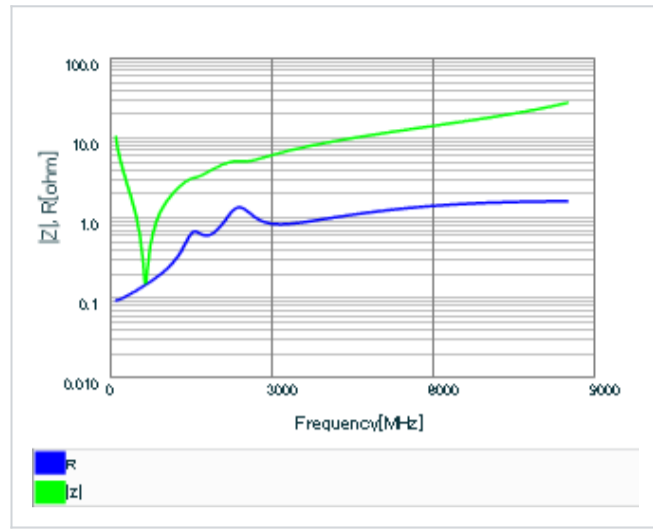

▪ S parameter (Smith chart S11)

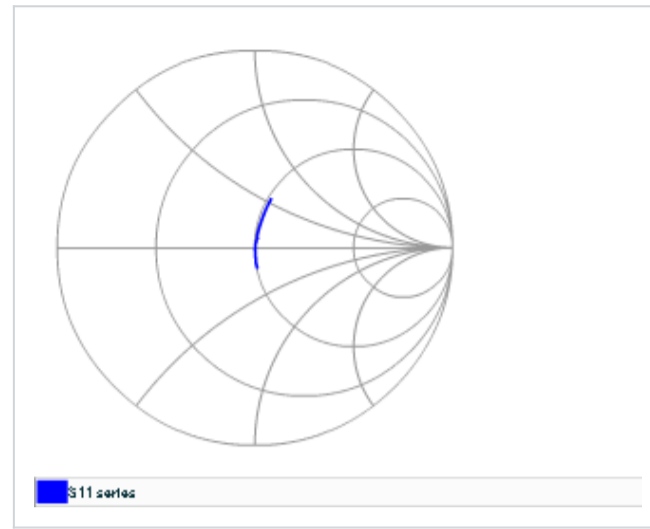

▪ DC bias characteristics

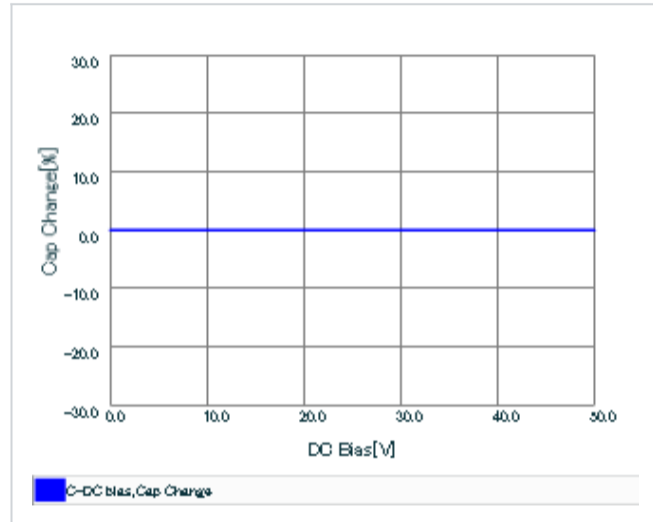

▪ AC voltage characteristics

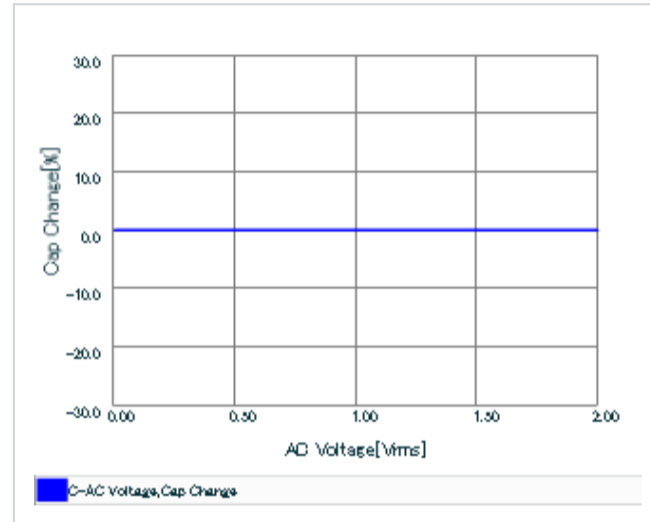

▪ Capacitance - temperature characteristics

