

GRM1555C1H4R7BA01#

"#" indicates a package specification code.



< List of part numbers with package codes >
 GRM1555C1H4R7BA01D , GRM1555C1H4R7BA01W , GRM1555C1H4R7BA01J

Shape

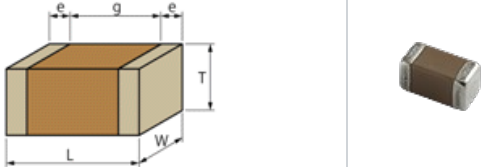

L size	1.0 ±0.05mm
W size	0.5 ±0.05mm
T size	0.5 ±0.05mm
External terminal width e	0.15 to 0.35mm
Distance between external terminals g	0.3mm min.
Size code in inch(mm)	0402 (1005M)

References

Packaging	Specifications	Minimum quantity
D	φ 180mm Paper taping	10000
J	φ 330mm Paper taping	50000
W	φ 180mm Paper taping (W8P1*) * Width : 8mm, Pocket pitch : 1mm	20000

Mass (typ.)	
1 piece	1.6mg
φ 180mm Reel	118g

Specifications

Capacitance	4.7pF ±0.1pF
Rated voltage	50Vdc
Temperature characteristics (complied standard)	COG(EIA)
Temperature coefficient	0±30ppm/°C
Temperature range of temperature characteristics	25 to 125°C
Operating temperature range	-55 to 125°C

⚠ Attention

- 1.This datasheet is downloaded from the website of Murata Manufacturing Co., Ltd. Therefore, it's specifications are subject to change or our products in it may be discontinued without advance notice. Please check with our sales representatives or product engineers before ordering.
- 2.This datasheet has only typical specifications because there is no space for detailed specifications. Therefore, please review our product specifications or consult the approval sheet for product specifications before ordering.