

This document is the property of Amphenol Corporation and is delivered on the express condition that it is not to be disclosed, reproduced or used, in whole or in part, for manufacture or sale by anyone other than Amphenol Corporation without its prior consent, and that no right is granted to disclose or to use any information in this document.

The marking on this product doesn't contain environmental hazardous materials per Material Specification SS-00259 for Sony GP compliant or per directive 2011/65/EU for RoHS compliant.



ORIGINAL



REVISIONS				
SYM	ECN No.	DESCRIPTION	DATE	APPROVED
A	NE-15011	NON-RELEASE REVISION	01/23/2015	Arron Lin
B	NE-16190	UPDATE PACKING QUANTITY	08/22/2016	Arron Lin

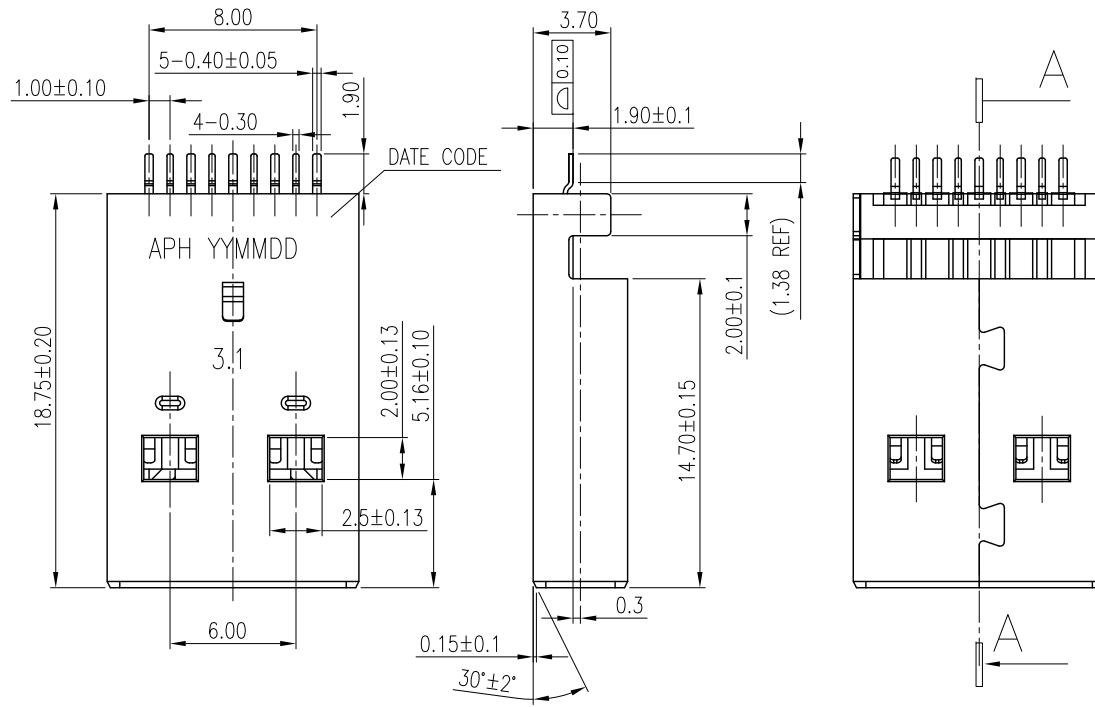

- NOTES:
- MATERIAL:
    - HOUSING: HIGH TEMPERATURE THERMAL PLASTIC LCP UL94-V0, COLOR: BLUE 300C.
    - TERMINAL: COPPER ALLOY.
    - SHIELD: SPCC.
  - FINISH:
    - TERMINAL: CONTACT AREA: SELECTIVE PLATING; SOLDERING AREA: MATTE TIN PLATING 100 μ" THICKNESS MIN.; UNDER PLATING: NICKEL PLATING 50 μ" THICKNESS MIN. OVERALL.
    - SHIELD: NICKEL PLATING 50 μ" THICKNESS MIN. OVERALL.
  - PACKING IS PER AMTA PACKING SPECIFICATION PKS-0001.
  - THIS PRODUCT DOESN'T CONTAIN ENVIRONMENTAL HAZARDOUS PER DIRECTIVE 2011/65/EU FOR RoHS COMPLIANT.
  - PRODUCT SPECIFICATION REFER TO : PS-7530.

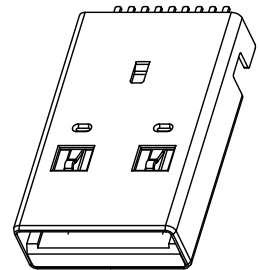
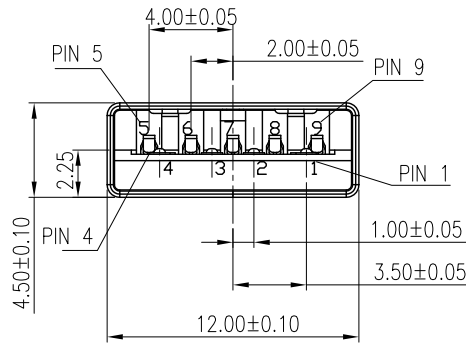

P/N : GSB4164 X 5 X HR  
 CONTACT FINISH : 4: 30u" GOLD  
 PACKING OPTIONS : C: T&R, 3: TRAY

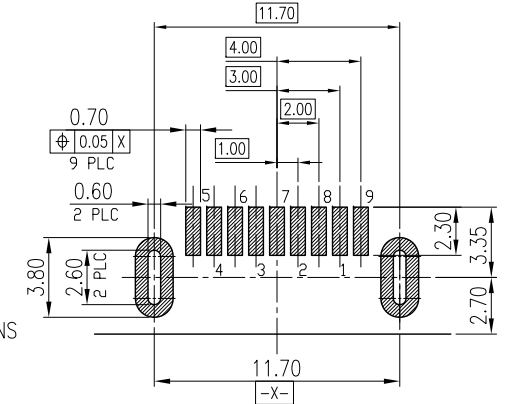

RECOMMEND P.C.B LAYOUT (THICKNESS=1.2mm)  
 (COMPONENT SIDE) TOLERANCE

TOLERANCE	APPROVALS	DATE	TITLE		PART No.	
X. ±0.30	DRAWN Debby Hung	08/22/2016	USB 3.1 A TYPE PLUG, SMT 0.3mm OFFSET CENTER LINE.		Amphenol® Amphenol Corporation Amphenol Taiwan Corporation	
X.X ±0.20	CHECKED Roger Tsai	08/22/2016				
X.XXX ±0.10	APPROVED Arron Lin	08/22/2016	UNIT mm		SIZE A3	PART No. GSB4164X5XHR
ANGULAR ±1°	DWG TYPE CUST DWG	PROJECT CODE OTHER	SCALE NA	SHEET 1 OF 3	DWG No. GSB4164X5XHR	REV. B
UNLESS OTHERWISE SPECIFIED						

This document is the property of Amphenol Corporation and is delivered on the express condition that it is not to be disclosed, reproduced or used, in whole or in part, for manufacture or sale by anyone other than Amphenol Corporation without its prior consent, and that no right is granted to disclose or to use any information in this document.

The marking on this product doesn't contain environmental hazardous materials per Material Specification 55-00259 for Sony GP compliant or per directive 2011/65/EU for RoHS compliant.



ORIGINAL



REVISIONS				
SYM	ECN No.	DESCRIPTION	DATE	APPROVED
A	NE-15011	NON-RELEASE REVISION	01/23/2015	Arron Lin
B	NE-16190	UPDATE PACKING QUANTITY	08/22/2016	Arron Lin

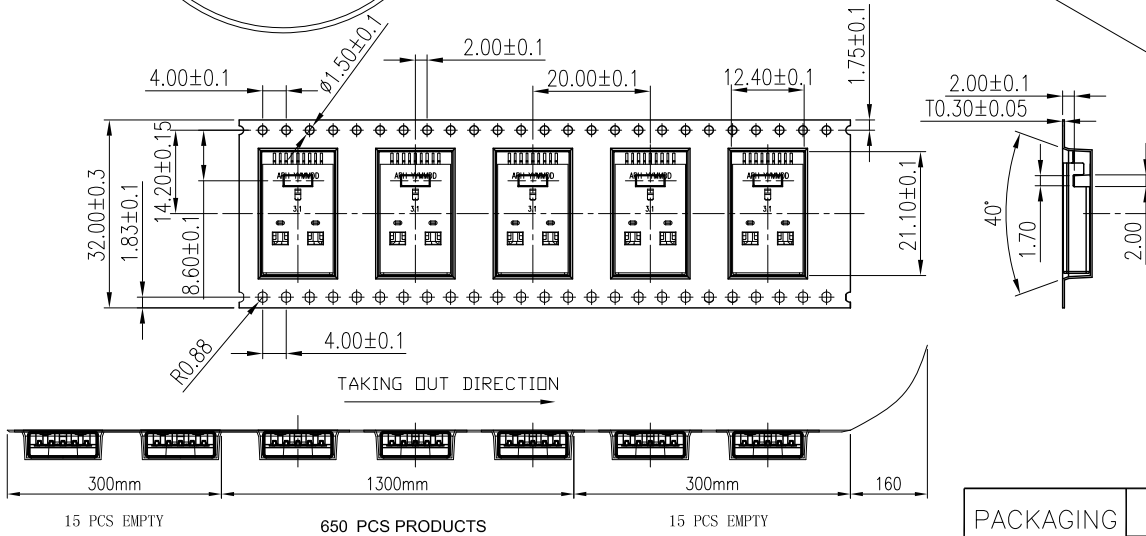
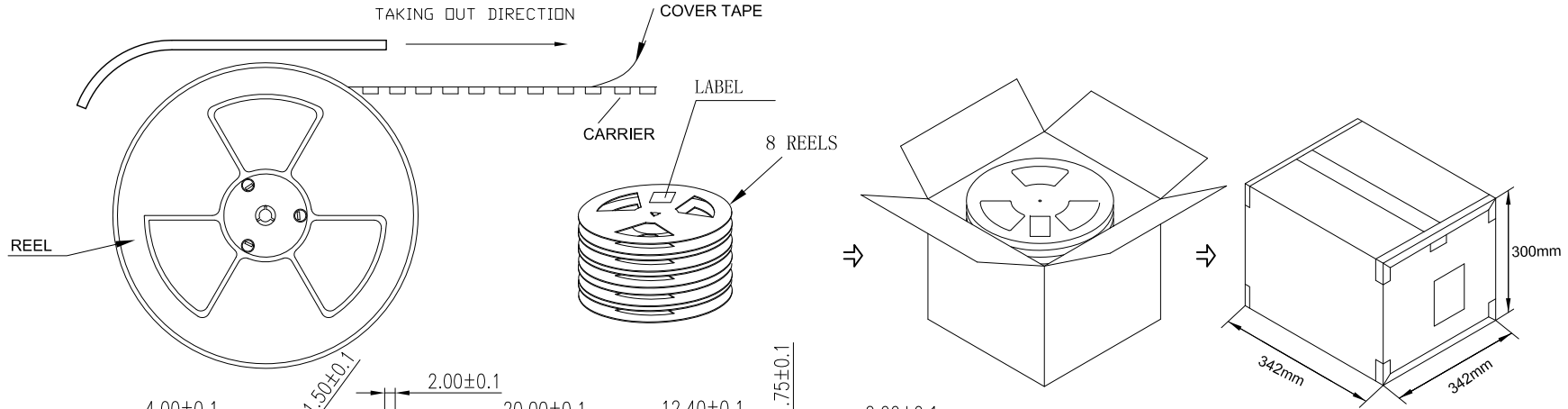

PACKAGING BY T&R	10.0	7.68	650	8	5200	GSB4164X5CHR
	G/W KG	N/W KG	PCS/ REEL	REELS/ BOX	QUANTITY (PCS)	PART NUMBER

TOLERANCE	APPROVALS	DATE	TITLE		PART No.	
X. ±0.30	DRAWN Debby Hung	08/22/2016	USB 3.0 A TYPE PLUG, SMT 0.3mm OFFSET CENTER LINE.		<b>Amphenol®</b> Amphenol Corporation Amphenol Taiwan Corporation	
X.X ±0.20	CHECKED Roger Tsai	08/22/2016				
X.XXX ±0.10	APPROVED Arron Lin	08/22/2016			UNIT mm SCALE NA	SIZE A3 SHEET 2 OF 3
ANGULAR ±1°	DWG TYPE CUST DWG	PROJECT CODE OTHER			PART No. GSB4164X5XHR DWG No. GSB4164X5XHR	REV. B
UNLESS OTHERWISE SPECIFIED						

This document is the property of Amphenol Corporation and is delivered on the express condition that is not to be disclosed, reproduced or used, in whole or in part, for manufacture or sale by anyone other than Amphenol Corporation without its prior consent, and that no right is granted to disclose or to use any information in this document.

The marking on this product doesn't contain environmental hazardous materials per Material Specification SS-00259 for Sony GP compliant or per directive 2011/65/EU for RoHS compliant.



ORIGINAL



REVISIONS				
SYM	ECN No.	DESCRIPTION	DATE	APPROVED
A	NE-15011	NON-RELEASE REVISION	01/23/2015	Arron Lin
B	NE-16190	UPDATE PACKING QUANTITY	08/22/2016	Arron Lin

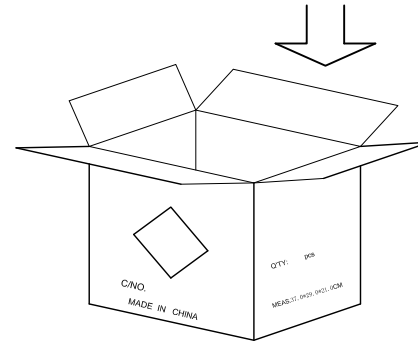
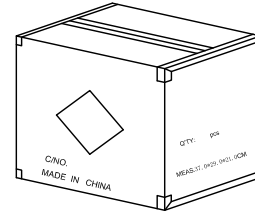
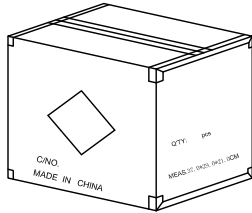
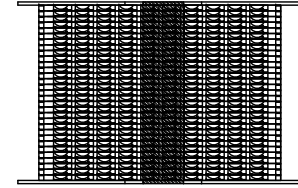
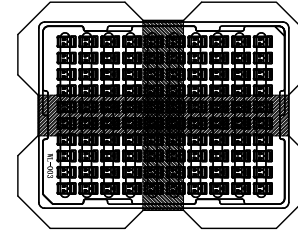
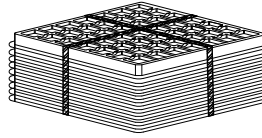
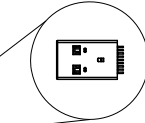
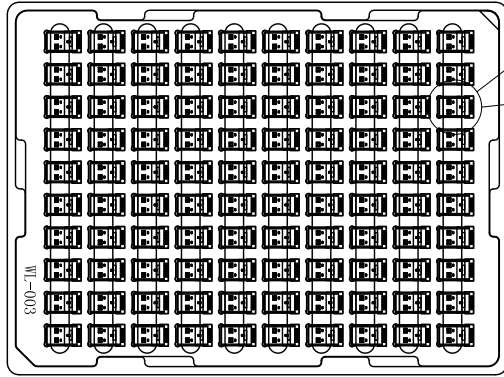

NOTES:  
1. CARTON SIZE: 370 X 290 X 210 mm

PACKAGING BY TRAY	10	7.2	100	30	3000	GSB4164X53HR
	G/W KG	N/W KG	PCS/TRAY	TRAYS/BOX	QUANTITY (PCS)	PART NUMBER

TOLERANCE	APPROVALS	DATE	TITLE		PART No.	
X. ±0.30	DRAWN Debby Hung	08/22/2016	USB 3.1 A TYPE PLUG, SMT 0.3mm OFFSET CENTER LINE.		<b>Amphenol®</b> Amphenol Corporation Amphenol Taiwan Corporation	
X.X ±0.20	CHECKED Roger Tsai	08/22/2016				
X.XX ±0.10	APPROVED Arron Lin	08/22/2016	UNIT mm		SIZE A3	PART No. GSB4164X5XHR
ANGULAR ±1°	DWG TYPE CUST DWG	PROJECT CODE OTHER	SCALE NA	SHEET 3 OF 3	DWG No. GSB4164X5XHR	REV. B
UNLESS OTHERWISE SPECIFIED						