

L2N7002LT1G

S-L2N7002LT1G

Small Signal MOSFET

115 mAmps, 60 Volts N-Channel SOT-23

1. FEATURES

- We declare that the material of product compliance with RoHS requirements and Halogen Free.
- S- prefix for automotive and other applications requiring unique site and control change requirements; AEC-Q101 qualified and PPAP capable.
- ESD Protected:1000V

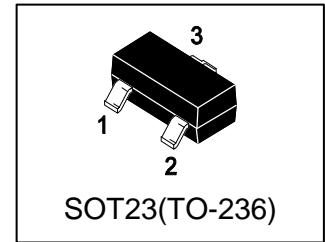

2. DEVICE MARKING AND ORDERING INFORMATION

Device	Marking	Shipping
L2N7002LT1G	702	3000/Tape&Reel
L2N7002LT3G	702	10000/Tape&Reel

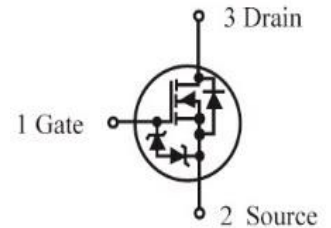

3. MAXIMUM RATINGS(Ta = 25°C)

Parameter	Symbol	Limits	Unit
Drain-Source Voltage	VDSS	60	Vdc
Drain-Gate Voltage (RGS = 1.0 MΩ)	VDGR	60	Vdc
Drain Current	ID		mAdc
- Continuous TC = 25°C		±115	
TC = 100°C		±75	
- Pulsed (Note 1)	IDM	±800	
Gate-Source Voltage			
- Continuous	VGS	±20	Vdc
- Non-repetitive (tp ≤ 50μs)	VGSM	±40	Vdc

4. THERMAL CHARACTERISTICS

Parameter	Symbol	Limits	Unit
Total Device Dissipation, FR-5 Board (Note 2) @ TA = 25°C	PD	225	mW
Derate above 25°C		1.8	mW/°C
Thermal Resistance, Junction-to-Ambient(Note 2)	RθJA	556	°C/W
Junction and Storage temperature	TJ,Tstg	-55~+150	°C

1. Pulse Test: Pulse Width ≤ 300 μs, Duty Cycle ≤ 2.0%.

2. FR-5 = 1.0×0.75×0.062 in.

5. ELECTRICAL CHARACTERISTICS (Ta= 25°C)
OFF CHARACTERISTICS

Characteristic	Symbol	Min.	Typ.	Max.	Unit
Drain–Source Breakdown Voltage (VGS = 0, ID = 10μAdc)	VBRDSS	60	-	-	Vdc
Zero Gate Voltage Drain Current TJ = 25°C (VGS = 0, VDS = 60 Vdc) TJ = 125°C	IDSS	-	-	1.0	μAdc
		-	-	500	
Gate–Body Leakage Current, Forward (VGS = 20 Vdc)	IGSSF	-	-	1.0	μAdc
Gate–Body Leakage Current, Reverse (VGS = - 20 Vdc)	IGSSR	-	-	-1.0	μAdc

ON CHARACTERISTICS (Note 3)

Gate Threshold Voltage (VDS = VGS, ID = 250μAdc)	VGS(th)	1.0	1.6	2.0	Vdc
On–State Drain Current (VDS ≥ 2.0 VDS(on), VGS = 10 Vdc)	ID(on)	500	-	-	mA
Static Drain–Source On–State Voltage (VGS = 10 Vdc, ID = 500 mAdc) (VGS = 5.0 Vdc, ID = 50 mAdc)	VDS(on)	-	-	3.75	Vdc
		-	-	0.375	
Static Drain–Source On–State Resistance (VGS = 10 Vdc, ID = 500 mAdc) TC = 25°C TC = 125°C (VGS = 5.0 Vdc, ID = 50 mAdc) TC = 25°C TC = 125°C	RDS(on)	-	1.4	7.5	Ohms
		-	-	13.5	
		-	1.8	7.5	
		-	-	13.5	
Forward Transconductance (VDS ≥ 2.0 VDS(on), ID = 200 mAdc)	gfs	80	-	-	mmhos

DYNAMIC CHARACTERISTICS

Input Capacitance (VDS = 25 V, VGS = 0, f = 1.0 MHz)	Ciss	-	17	50	pF
Output Capacitance (VDS = 25 V, VGS = 0, f = 1.0 MHz)	Coss	-	10	25	pF
Reverse Transfer Capacitance (VDS = 25 V, VGS = 0, f = 1.0 MHz)	Crss	-	2.5	5.0	pF

SWITCHING CHARACTERISTICS

Turn-On Delay Time	(VDD = 25 Vdc, ID = 500 mAdc, RG = 25Ω, RL = 50 Ω, Vgen = 10 V)	td(on)	-	7	20	ns
Turn-Off Delay Time		td(off)	-	11	40	

BODY–DRAIN DIODE RATINGS

Diode Forward On–Voltage (IS = 115 mAdc, VGS = 0 V)	VSD	-	-	-1.5	Vdc
Source Current Continuous (Body Diode)	IS	-	-	-115	mAdc
Source Current Pulsed	ISM	-	-	-800	mAdc

3.Pulse Test: Pulse Width ≤300 μs, Duty Cycle ≤2.0%.

6. ELECTRICAL CHARACTERISTICS CURVES

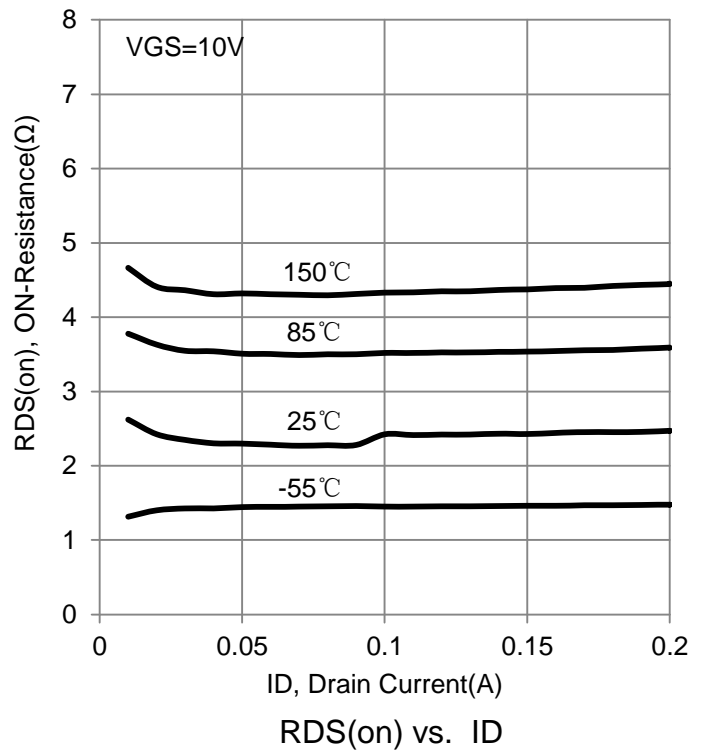
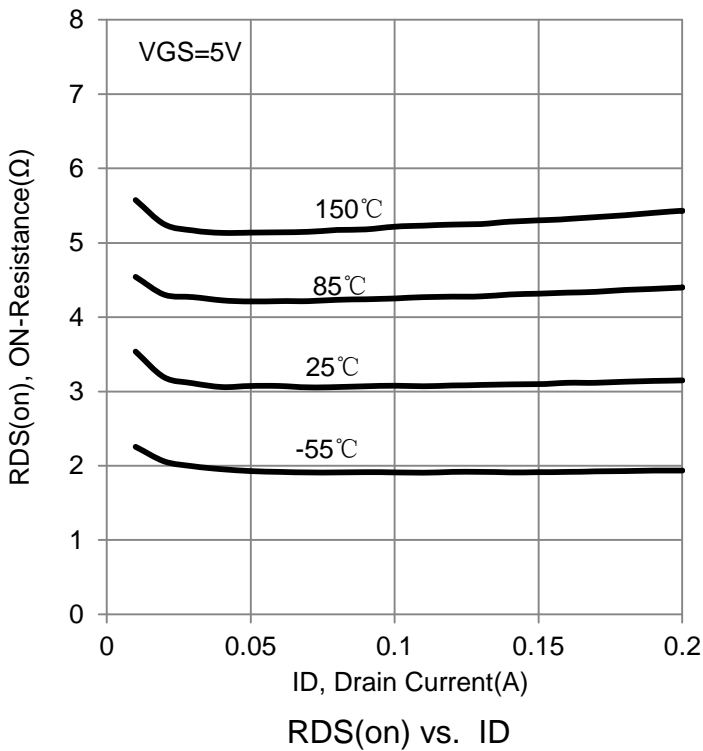
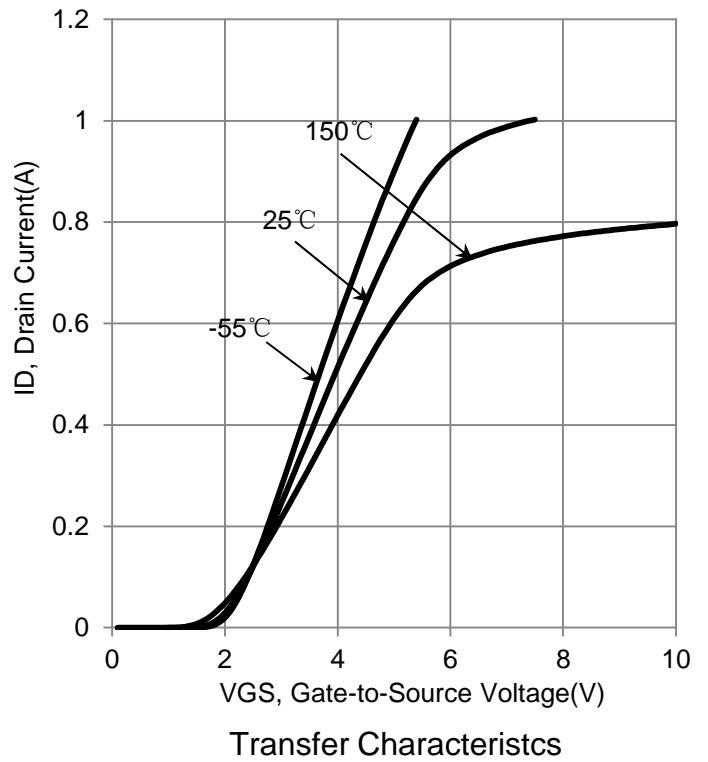
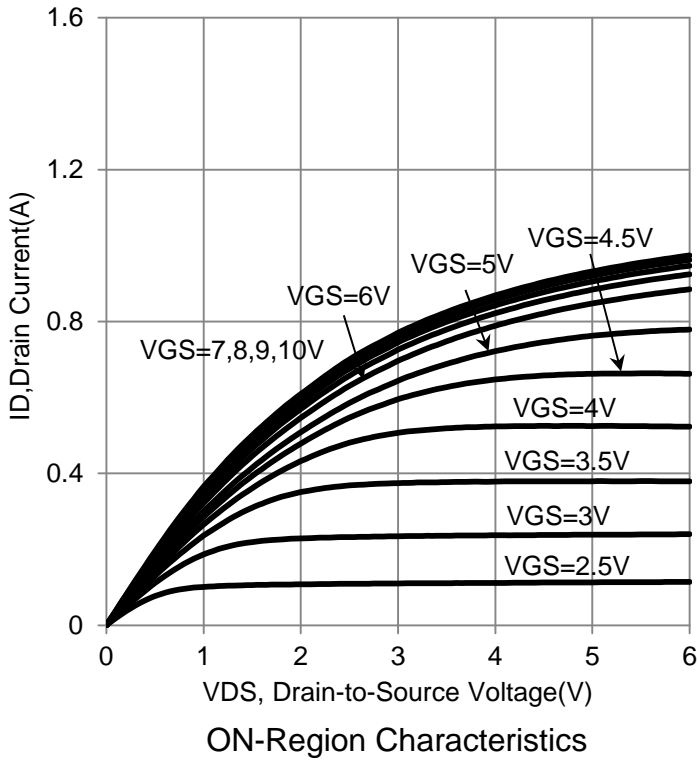

6. ELECTRICAL CHARACTERISTICS CURVES (Con.)

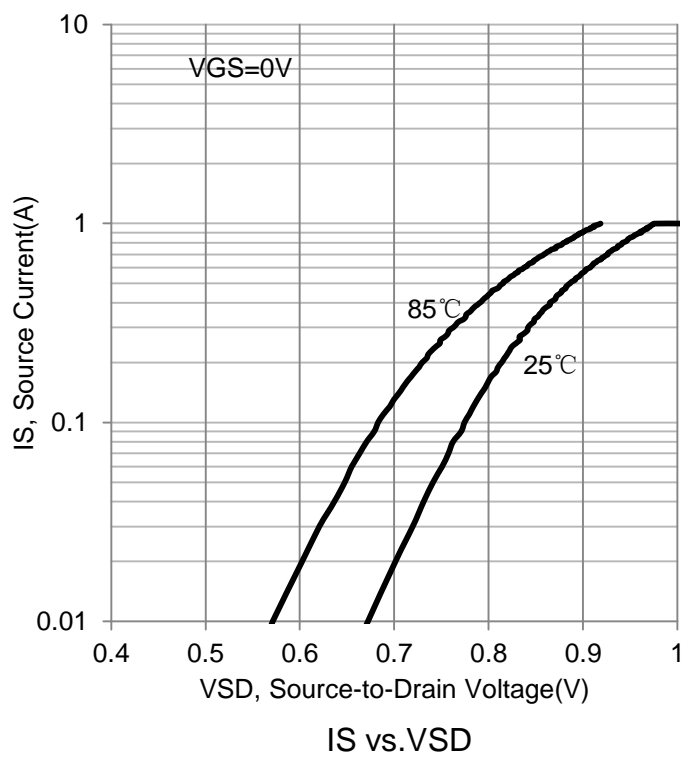
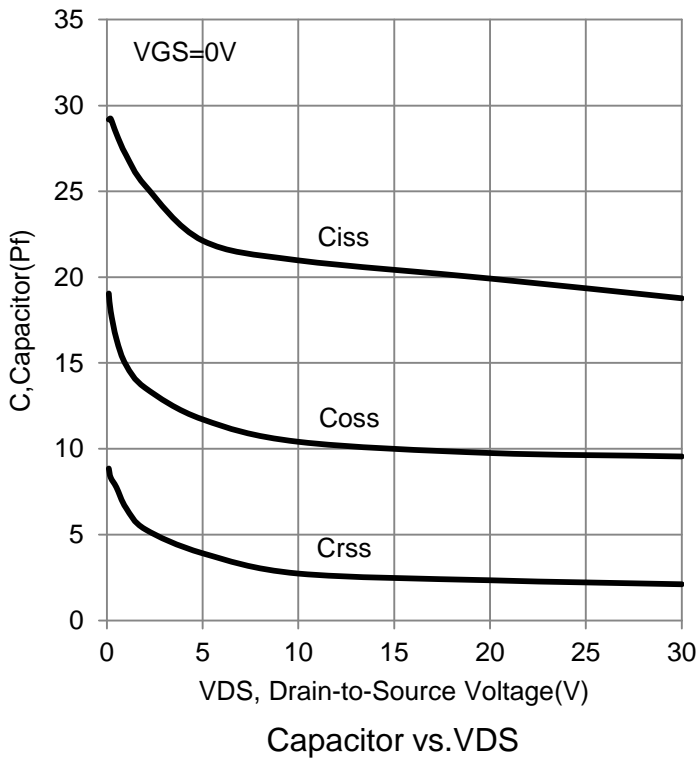
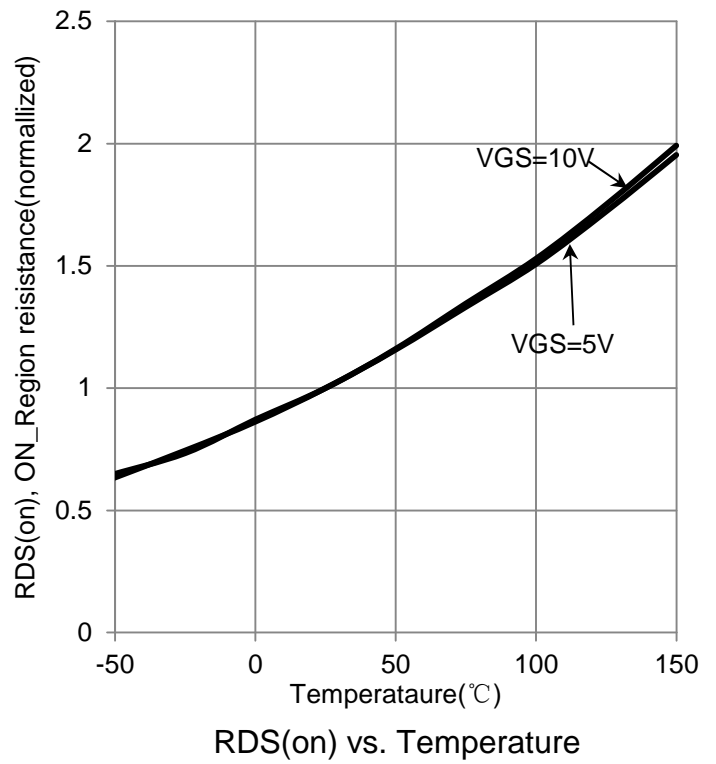
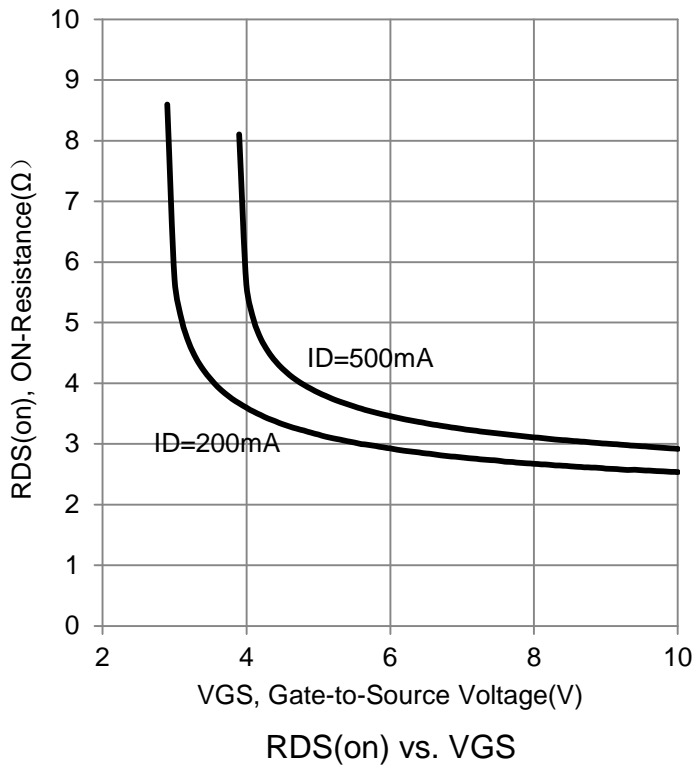

6. ELECTRICAL CHARACTERISTICS CURVES (Con.)

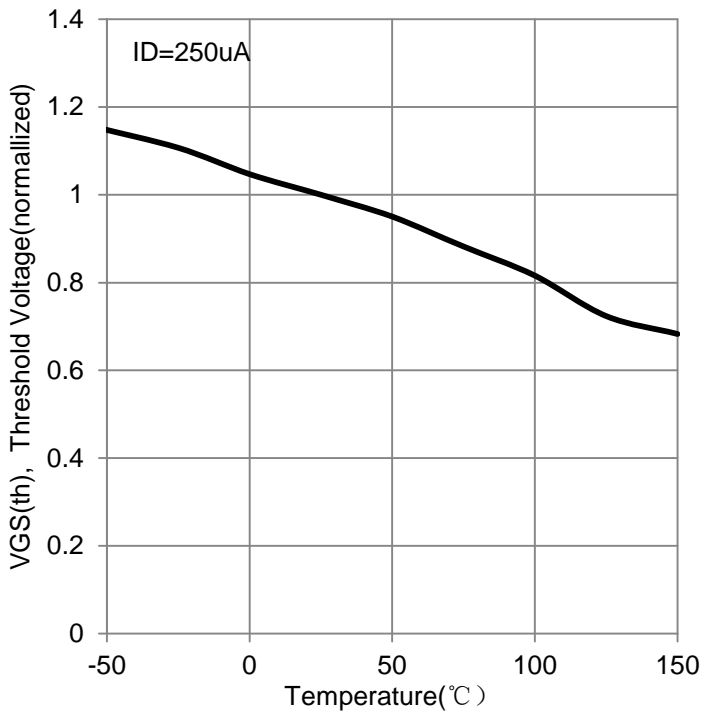

VGS(th) vs. Temperature

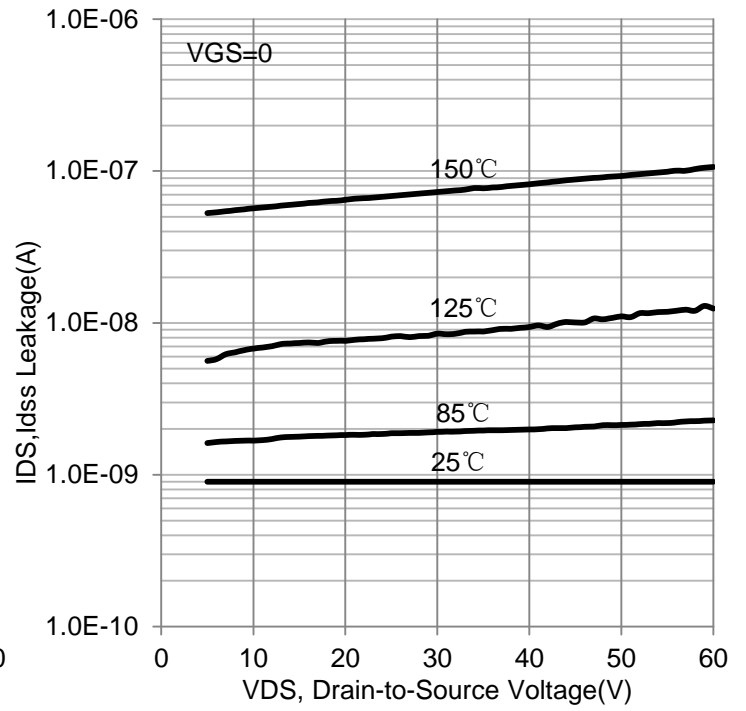

IDS vs. VDS

7.OUTLINE AND DIMENSIONS

Notes:

1. DIMENSIONING AND TOLERANCING PER ANSI Y14.5M, 1982.
2. CONTROLLING DIMENSION: MILLIMETERS.
3. MAXIMUM LEAD THICKNESS INCLUDES LEAD FINISH. MINIMUM LEAD THICKNESS IS THE MINIMUM THICKNESS OF BASE MATERIAL.
4. DIMENSIONS D AND E DO NOT INCLUDE MOLD FLASH, PROTRUSIONS OR GATE BURRS.

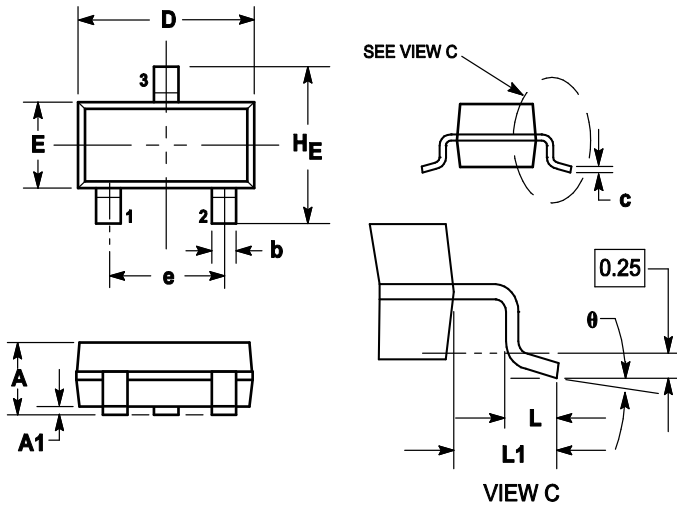

DIM	MILLIMETERS			INCHES		
	MIN	NOM	MAX	MIN	NOM	MAX
A	0.89	1	1.11	0.035	0.04	0.044
A1	0.01	0.06	0.1	0.001	0.002	0.004
b	0.37	0.44	0.5	0.015	0.018	0.02
c	0.09	0.13	0.18	0.003	0.005	0.007
D	2.80	2.9	3.04	0.11	0.114	0.12
E	1.20	1.3	1.4	0.047	0.051	0.055
e	1.78	1.9	2.04	0.07	0.075	0.081
L	0.10	0.2	0.3	0.004	0.008	0.012
L1	0.35	0.54	0.69	0.014	0.021	0.029
HE	2.10	2.4	2.64	0.083	0.094	0.104
θ	0°	---	10°	0°	---	10°

8.SOLDERING FOOTPRINT

