

LQH43MN330J03#

"#" indicates a package specification code.

Size Code 4532 (1812) in mm (in inch)



< List of part numbers with package codes >
LQH43MN330J03K LQH43MN330J03L

Appearance & Shape

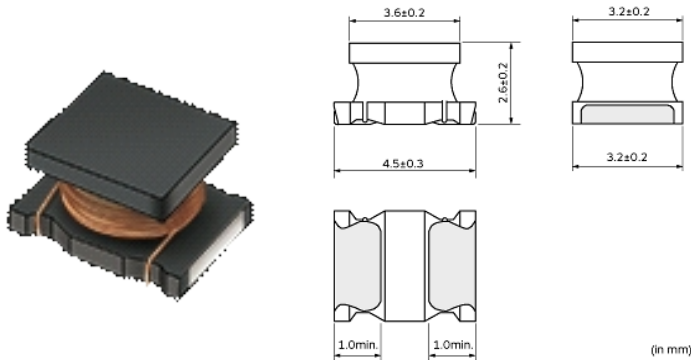

References

Packaging	Specifications	Minimum Order Quantity
K	330Embossed Tape	2500
L	180Embossed Tape	500

Mass (typ.)	
1 piece	0.13g

Notices

When rated current is applied to the products, self-temperature rise shall be limited to 20°C max and inductance will be within ±10% of initial inductance value.

Attention
1.This datasheet is downloaded from the website of Murata Manufacturing Co., Ltd. Therefore, it's specifications are subject to change or our products in it may be discontinued without advance notice. Please check with our sales representatives or product engineers before ordering.
2.This datasheet has only typical specifications because there is no space for detailed specifications.
Therefore, please review our product specifications or consult the approval sheet for product specifications before ordering.

LQH43MN330J03#

"#" indicates a package specification code.

Specifications

L size	4.5±0.3mm
W size	3.2±0.2mm
T size	2.6±0.2mm
Size code inch (mm)	1812 (4532)
Inductance	33μH±5%
Inductance Test Frequency	1MHz
Rated current (Itemp) (Based on Temperature rise)	270mA
Max. of DC resistance	1.2Ω
Class of magnetic shield	No Shield
Q(min.)	35
Q Test Frequency	1MHz
Self resonance frequency (min.)	12MHz
Operating Temperature Range(Self-temperature rise is not included)	-40°C to 85°C
Series	LQH43MN_03

Attention

- 1.This datasheet is downloaded from the website of Murata Manufacturing Co., Ltd. Therefore, it's specifications are subject to change or our products in it may be discontinued without advance notice. Please check with our sales representatives or product engineers before ordering.
- 2.This datasheet has only typical specifications because there is no space for detailed specifications.
Therefore, please review our product specifications or consult the approval sheet for product specifications before ordering.

LQH43MN330J03#

"#" indicates a package specification code.

Product Data

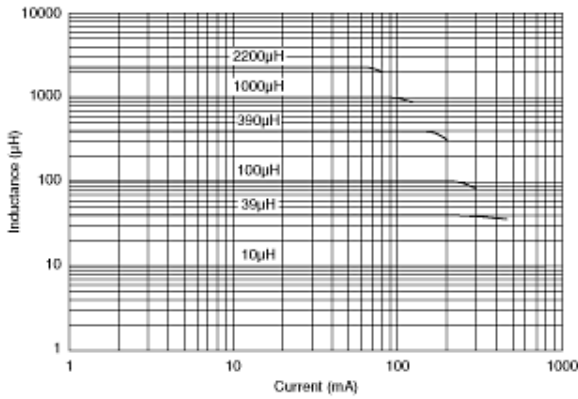

Impedance - Current Characteristics

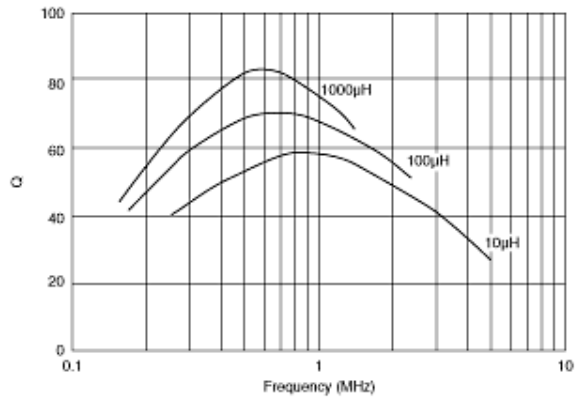

Q-Frequency Characteristics

Attention

- 1.This datasheet is downloaded from the website of Murata Manufacturing Co., Ltd. Therefore, it's specifications are subject to change or our products in it may be discontinued without advance notice. Please check with our sales representatives or product engineers before ordering.
 - 2.This datasheet has only typical specifications because there is no space for detailed specifications.
- Therefore, please review our product specifications or consult the approval sheet for product specifications before ordering.