

LQH43PN2R2M26#

"#" indicates a package specification code.

Size Code 4532 (1812) in mm (in inch), 2.8mm max. Thickness



< List of part numbers with package codes >

LQH43PN2R2M26K LQH43PN2R2M26L

Appearance & Shape

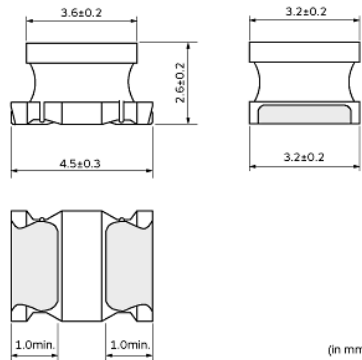
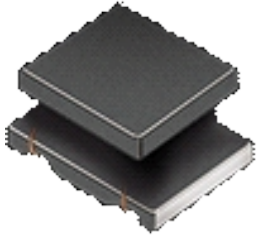

(in mm)

Notices

When rated current is applied to the products, inductance will be within $\pm 30\%$ of nominal inductance value. When rated current is applied to the products, the temperature rise caused by self-generated heat shall be limited to 40°C max. Keep the temperature (ambient temperature plus self-generation of heat) under 125°C.

Attention

1.This datasheet is downloaded from the website of Murata Manufacturing Co., Ltd. Therefore, it's specifications are subject to change or our products in it may be discontinued without advance notice. Please check with our sales representatives or product engineers before ordering.

2.This datasheet has only typical specifications because there is no space for detailed specifications.

Therefore, please review our product specifications or consult the approval sheet for product specifications before ordering.

LQH43PN2R2M26#

"#" indicates a package specification code.

References

| Packaging | Specifications | Minimum Order Quantity |
|-----------|------------------|------------------------|
| K | 330Embossed Tape | 2500 |
| L | 180Embossed Tape | 500 |

| Mass (typ.) | |
|-------------|-------|
| 1 piece | 0.13g |

Attention

- 1.This datasheet is downloaded from the website of Murata Manufacturing Co., Ltd. Therefore, it's specifications are subject to change or our products in it may be discontinued without advance notice. Please check with our sales representatives or product engineers before ordering.
 - 2.This datasheet has only typical specifications because there is no space for detailed specifications.
- Therefore, please review our product specifications or consult the approval sheet for product specifications before ordering.

LQH43PN2R2M26#

"#" indicates a package specification code.

Specifications

| | |
|--|----------------|
| L size | 4.5±0.3mm |
| W size | 3.2±0.2mm |
| T size | 2.6±0.2mm |
| Size code inch (mm) | 1812 (4532) |
| Inductance | 2.2μH±20% |
| Inductance Test Frequency | 1MHz |
| Rated current (I _{sat}) (Based on Inductance change) | 2300mA |
| Rated current (I _{temp}) (Based on Temperature rise) | 2500mA |
| Max. of DC resistance | 0.0504Ω |
| Class of magnetic shield | Magnetic Resin |
| Self resonance frequency (min.) | 45MHz |
| Operating Temperature Range(Self-temperature rise is not included) | -40°C to 85°C |
| DC Resistance Intermediate Values | 0.042Ω±20% |
| Series | LQH43PN_26 |

Attention

1.This datasheet is downloaded from the website of Murata Manufacturing Co., Ltd. Therefore, it's specifications are subject to change or our products in it may be discontinued without advance notice. Please check with our sales representatives or product engineers before ordering.

2.This datasheet has only typical specifications because there is no space for detailed specifications.

Therefore, please review our product specifications or consult the approval sheet for product specifications before ordering.

LQH43PN2R2M26#

"#" indicates a package specification code.

Characteristic Data

The charts below may show another part number which shares its characteristics.

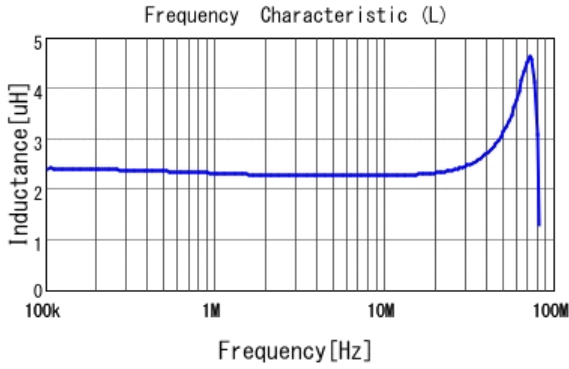

LQH43PN2R2M26 L

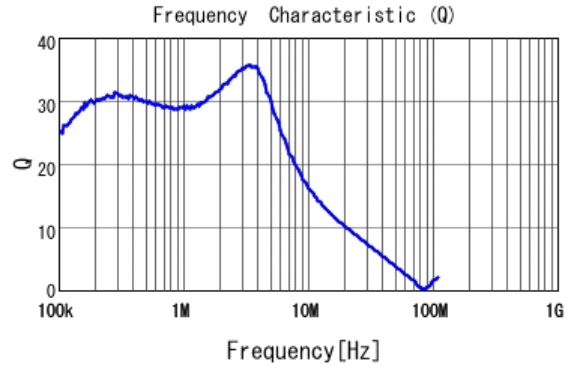

LQH43PN2R2M26 Q

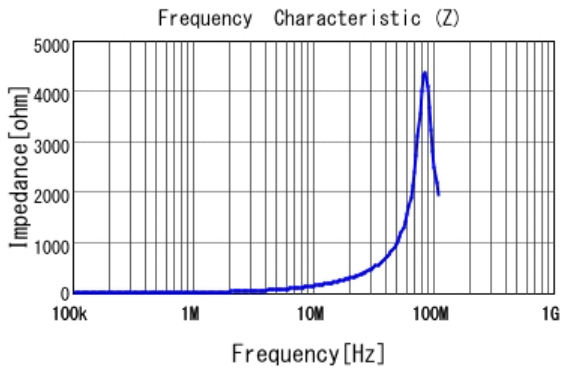

LQH43PN2R2M26 |Z|

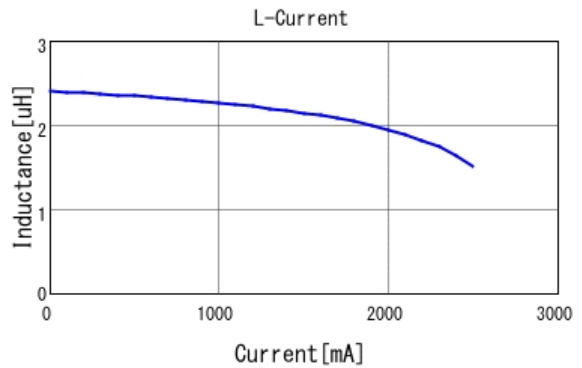

LQH43PN2R2M26 L-Current 20degC

Attention

- 1.This datasheet is downloaded from the website of Murata Manufacturing Co., Ltd. Therefore, it's specifications are subject to change or our products in it may be discontinued without advance notice. Please check with our sales representatives or product engineers before ordering.
 - 2.This datasheet has only typical specifications because there is no space for detailed specifications.
- Therefore, please review our product specifications or consult the approval sheet for product specifications before ordering.

LQH43PN2R2M26#

"#" indicates a package specification code.

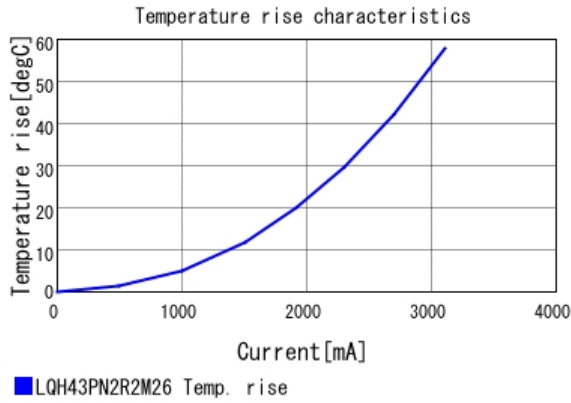

Attention

- 1.This datasheet is downloaded from the website of Murata Manufacturing Co., Ltd. Therefore, it's specifications are subject to change or our products in it may be discontinued without advance notice. Please check with our sales representatives or product engineers before ordering.
 - 2.This datasheet has only typical specifications because there is no space for detailed specifications.
- Therefore, please review our product specifications or consult the approval sheet for product specifications before ordering.