

LQM21PN1R0MC0#

“#” indicates a package specification code.

Size Code 2012 (0805) in mm (in inch), 0.55mm max. Thickness



< List of part numbers with package codes >

LQM21PN1R0MC0B LQM21PN1R0MC0D

Appearance & Shape

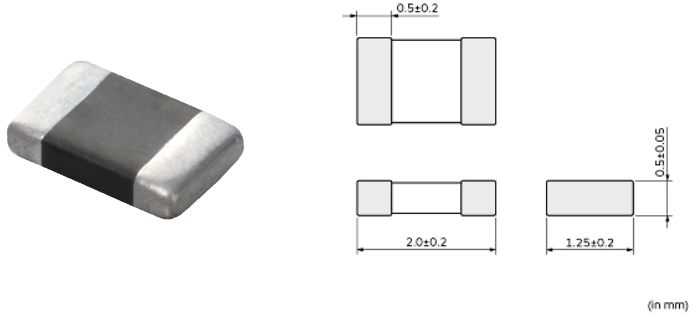

References

| Packaging | Specifications | Minimum Order Quantity |
|-----------|------------------|------------------------|
| B | Bulk(Bag) | 1000 |
| D | 180mm Paper Tape | 4000 |

| Mass (typ.) | |
|-------------|--------|
| 1 piece | 0.007g |

Notices

Please consider 'Notice (Rating).' When rated current is applied to the products, the temperature rise caused by self-generated heat shall be limited to 40°C max.

Attention

- 1.This datasheet is downloaded from the website of Murata Manufacturing Co., Ltd. Therefore, it's specifications are subject to change or our products in it may be discontinued without advance notice. Please check with our sales representatives or product engineers before ordering.
 - 2.This datasheet has only typical specifications because there is no space for detailed specifications.
- Therefore, please review our product specifications or consult the approval sheet for product specifications before ordering.

LQM21PN1R0MC0#

“#” indicates a package specification code.

Specifications

| | |
|---|--|
| L size | 2.0±0.2mm |
| W size | 1.25±0.2mm |
| T size | 0.5±0.05mm |
| Size code inch (mm) | 0805 (2012) |
| Inductance | 1μH±20% |
| Inductance Test Frequency | 1MHz |
| Rated current (Itemp) (Based on Temperature rise) | 0.8A(Ambient temp.85°C)0.60A(Ambient temp.125°C) |
| Max. of DC resistance | 0.238Ω |
| Class of magnetic shield | Ferrite Core |
| Self resonance frequency (min.) | 90MHz |
| DC Resistance Intermediate Values | 0.19Ω±25% |
| Operating Temperature Range | -55°C to 125°C |
| Series | LQM21PN_C0 |

Attention

1.This datasheet is downloaded from the website of Murata Manufacturing Co., Ltd. Therefore, it's specifications are subject to change or our products in it may be discontinued without advance notice. Please check with our sales representatives or product engineers before ordering.

2.This datasheet has only typical specifications because there is no space for detailed specifications.

Therefore, please review our product specifications or consult the approval sheet for product specifications before ordering.

LQM21PN1R0MC0#

“#” indicates a package specification code.

Notice For General

In operating temperatures exceeding +85°C, derating of current is necessary for this series.

Please apply the derating curve shown in the chart according to the operating temperature.

Derating of Rated Current

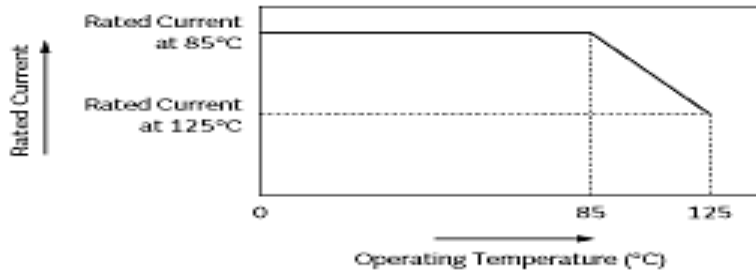

Attention

1.This datasheet is downloaded from the website of Murata Manufacturing Co., Ltd. Therefore, it's specifications are subject to change or our products in it may be discontinued without advance notice. Please check with our sales representatives or product engineers before ordering.

2.This datasheet has only typical specifications because there is no space for detailed specifications.

Therefore, please review our product specifications or consult the approval sheet for product specifications before ordering.

LQM21PN1R0MC0#

“#” indicates a package specification code.

Characteristic Data

The charts below may show another part number which shares its characteristics.

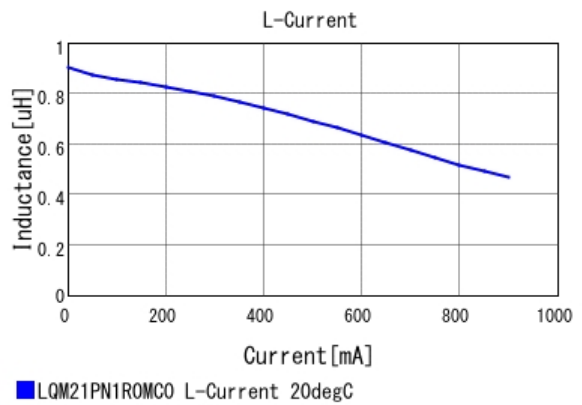
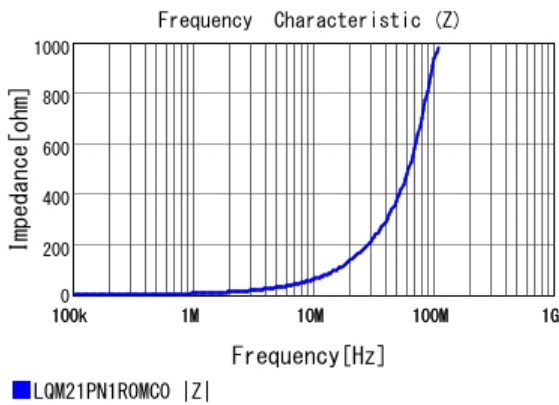
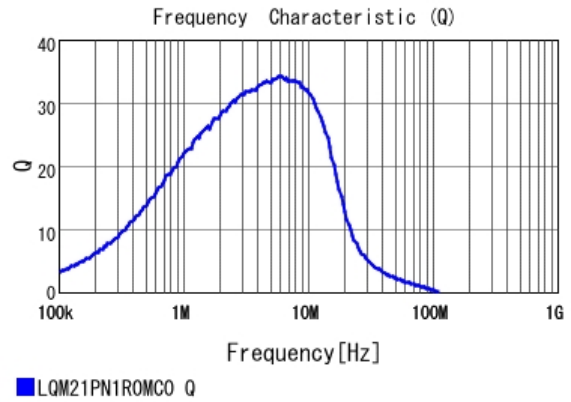
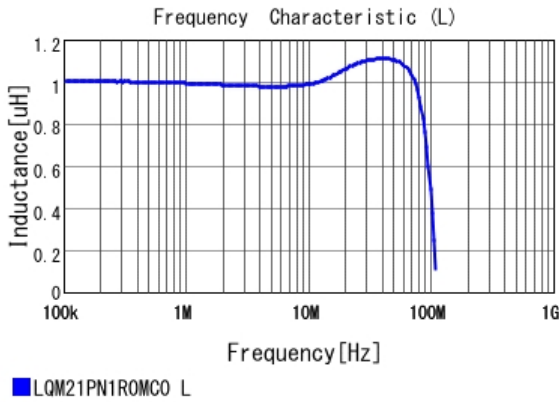

Attention

- 1.This datasheet is downloaded from the website of Murata Manufacturing Co., Ltd. Therefore, it's specifications are subject to change or our products in it may be discontinued without advance notice. Please check with our sales representatives or product engineers before ordering.
- 2.This datasheet has only typical specifications because there is no space for detailed specifications.
Therefore, please review our product specifications or consult the approval sheet for product specifications before ordering.

LQM21PN1R0MC0#

“#” indicates a package specification code.

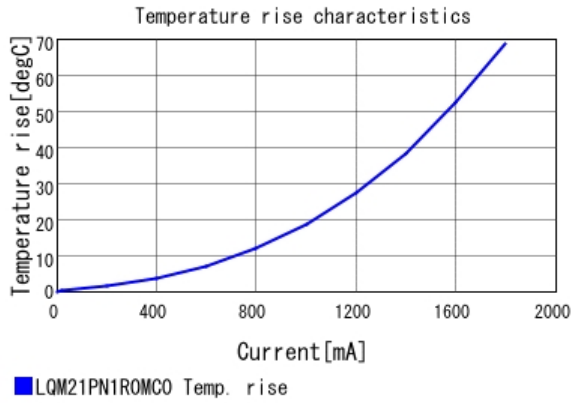

Attention

- 1.This datasheet is downloaded from the website of Murata Manufacturing Co., Ltd. Therefore, it's specifications are subject to change or our products in it may be discontinued without advance notice. Please check with our sales representatives or product engineers before ordering.
 - 2.This datasheet has only typical specifications because there is no space for detailed specifications.
- Therefore, please review our product specifications or consult the approval sheet for product specifications before ordering.