

LQW21HNR82J00#

"#" indicates a package specification code.

Size Code 2012 (0805) in mm (in inch), Ferrite Core High Frequency Wound Type



< List of part numbers with package codes >
LQW21HNR82J00L LQW21HNR82J00B

Appearance & Shape

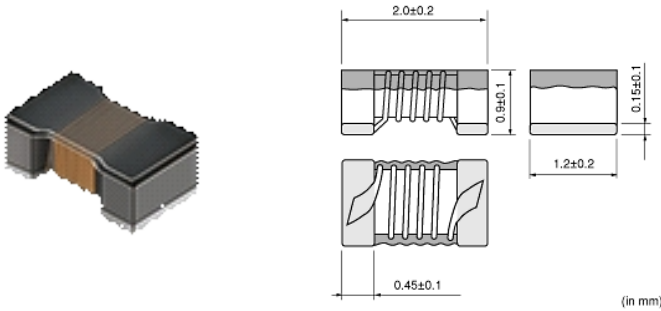

References

Packaging	Specifications	Minimum Order Quantity
L	180Embossed Tape	3000
B	Bulk(Bag)	500

Mass (typ.)	
1 piece	0.008g

Attention

- This datasheet is downloaded from the website of Murata Manufacturing Co., Ltd. Therefore, it's specifications are subject to change or our products in it may be discontinued without advance notice. Please check with our sales representatives or product engineers before ordering.
- This datasheet has only typical specifications because there is no space for detailed specifications.
Therefore, please review our product specifications or consult the approval sheet for product specifications before ordering.

LQW21HNR82J00#

"#" indicates a package specification code.

Specifications

L size	2.0±0.2mm
W size	1.2±0.2mm
T size	0.9±0.1mm
Size code inch (mm)	0805 (2012)
Inductance	0.82μH±5%
Inductance Test Frequency	10MHz
Rated current (Itemp) (Based on Temperature rise)	125mA
Max. of DC resistance	2.34Ω
Q(min.)	35
Q Test Frequency	100MHz
Self resonance frequency (min.)	480MHz
Operating Temperature Range(Self-temperature rise is not included)	-40°C to 85°C
Series	LQW21HN_00

Attention

1.This datasheet is downloaded from the website of Murata Manufacturing Co., Ltd. Therefore, it's specifications are subject to change or our products in it may be discontinued without advance notice. Please check with our sales representatives or product engineers before ordering.

2.This datasheet has only typical specifications because there is no space for detailed specifications.

Therefore, please review our product specifications or consult the approval sheet for product specifications before ordering.

LQW21HNR82J00#

"#" indicates a package specification code.

Characteristic Data

The charts below may show another part number which shares its characteristics.

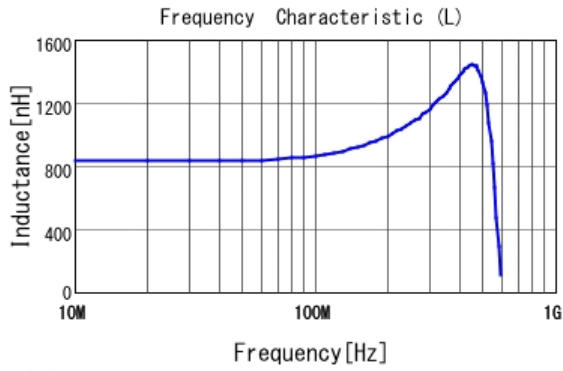

■ LQW21HNR82J00 L

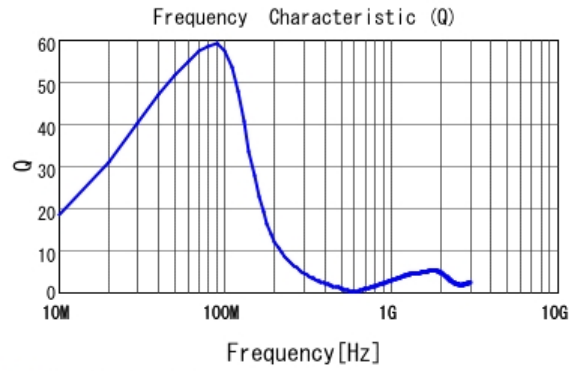

■ LQW21HNR82J00 Q

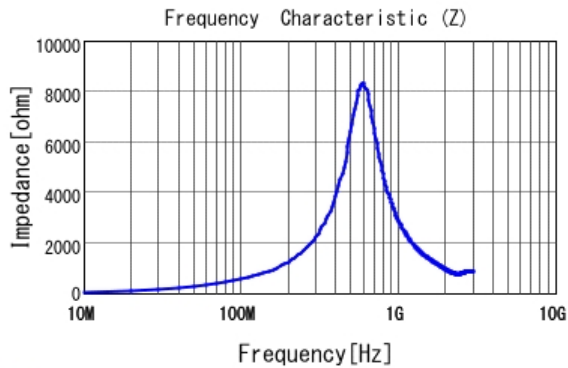

■ LQW21HNR82J00 |Z|

Attention

- 1.This datasheet is downloaded from the website of Murata Manufacturing Co., Ltd. Therefore, it's specifications are subject to change or our products in it may be discontinued without advance notice. Please check with our sales representatives or product engineers before ordering.
- 2.This datasheet has only typical specifications because there is no space for detailed specifications.
Therefore, please review our product specifications or consult the approval sheet for product specifications before ordering.