

LQW2BHN27NJ03#

“#” indicates a package specification code.

Size Code 2015 (0805) in mm (in inch), Wound Type



< List of part numbers with package codes >

LQW2BHN27NJ03K LQW2BHN27NJ03L

Appearance & Shape

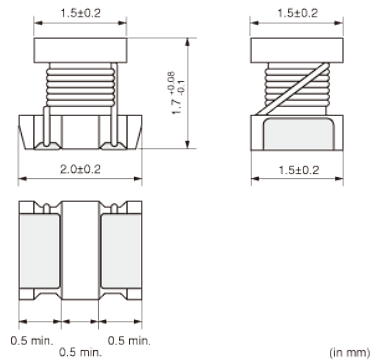

References

Packaging	Specifications	Minimum Order Quantity
K	330Embossed Tape	7500
L	180Embossed Tape	2000

Mass (typ.)	
1 piece	0.009g

Attention

1.This datasheet is downloaded from the website of Murata Manufacturing Co., Ltd. Therefore, it's specifications are subject to change or our products in it may be discontinued without advance notice. Please check with our sales representatives or product engineers before ordering.

2.This datasheet has only typical specifications because there is no space for detailed specifications.

Therefore, please review our product specifications or consult the approval sheet for product specifications before ordering.

LQW2BHN27NJ03#

“#” indicates a package specification code.

Specifications

L size	2.0±0.2mm
W size	1.5±0.2mm
T size	1.7+0.08/-0.1mm
Size code inch (mm)	0805 (2015)
Inductance	27nH±5%
Inductance Test Frequency	100MHz
Rated current (Itemp) (Based on Temperature rise)	540mA
Max. of DC resistance	0.17Ω
Q(min.)	40
Q Test Frequency	250MHz
Self resonance frequency (min.)	2300MHz
Operating Temperature Range(Self-temperature rise is not included)	-40°C to 85°C
Series	LQW2BHN_03

Attention

1.This datasheet is downloaded from the website of Murata Manufacturing Co., Ltd. Therefore, it's specifications are subject to change or our products in it may be discontinued without advance notice. Please check with our sales representatives or product engineers before ordering.

2.This datasheet has only typical specifications because there is no space for detailed specifications.

Therefore, please review our product specifications or consult the approval sheet for product specifications before ordering.

LQW2BHN27NJ03#

“#” indicates a package specification code.

Product Data

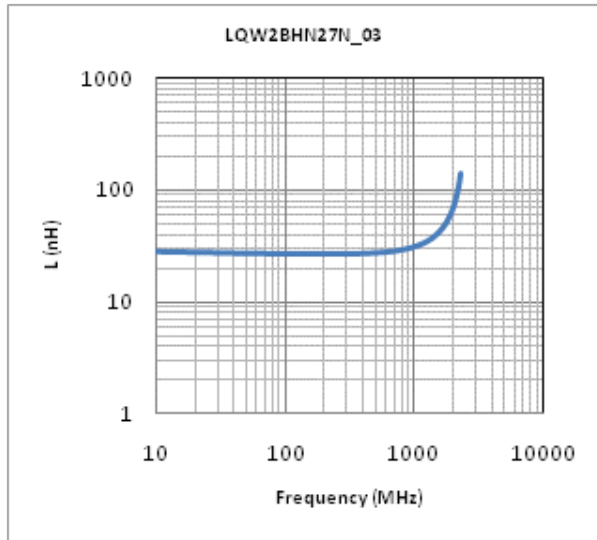

Inductance - Frequency Characteristics

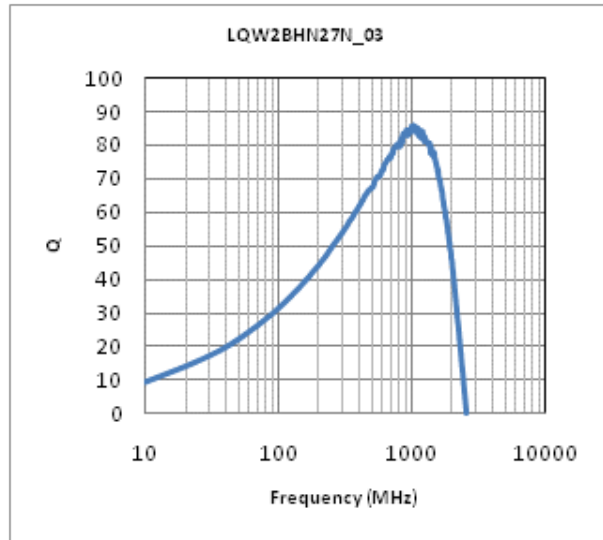

Q-Frequency Characteristics

Attention

- 1.This datasheet is downloaded from the website of Murata Manufacturing Co., Ltd. Therefore, it's specifications are subject to change or our products in it may be discontinued without advance notice. Please check with our sales representatives or product engineers before ordering.
 - 2.This datasheet has only typical specifications because there is no space for detailed specifications.
- Therefore, please review our product specifications or consult the approval sheet for product specifications before ordering.