

Film, Metallized Polyester Stacked, Commercial Grade, R82, 0.1 uF, 10%, 63 V, 85C, Lead Spacing = 5mm

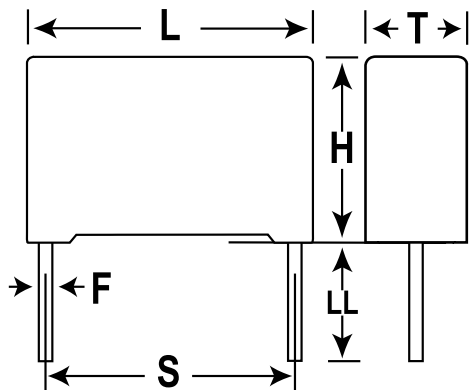

General Information	
Dielectric:	Metallized Polyester Stacked
Style:	Radial
Series:	R82
Features:	Pulse
RoHS:	Yes
Lead:	Cut
Approvals:	AEC-Q200
AEC-Q200:	Yes
Miscellaneous:	Above 85C DC And AC Voltage Derating Is 1.25%/C

Dimensions	
L	7.2mm +0.2mm
H	6.5mm +0.1mm
T	2.5mm +0.1mm
S	5mm +/-0.4mm
LL	4mm +1.5mm
F	0.5mm +/-0.05mm

Specifications	
Capacitance:	0.1 uF
Capacitance Tolerance:	10%
Voltage DC:	63 VDC
Voltage AC:	40 VAC
Temperature Range:	-55/+105C
Rated Temperature:	85C
Dissipation Factor:	0.8% 1kHz, 1.2% 10kHz, 2.5% 100kHz
Insulation Resistance:	15 GOhms
Max dVdt:	160 V
Inductance:	7 nH

Packaging Specifications	
Packaging:	Bulk
Packaging Quantity:	3000