

### INTRODUCTION:

Adam Tech USB (Universal Serial Bus) and IEEE 1394 (Firewire) Series connectors are a complete line of shielded, hot pluggable, high speed I/O interface connectors available in a variety of body styles, sizes, positions and mounting orientations. Each is shielded for superior EMI/RFI protection and features spring contacts for exceptional connectivity properties. Specially designed shells with flares eliminate misconnection and kinked boardlocks add a strong, stable PCB attachment. An ideal solution for a low cost, high speed connection to peripheral devices.

### FEATURES:

- Industry Standard Compatible
- High Speed I/O applications
- Variety of Circuit sizes
- Variety of Body Styles
- Standard and Mini versions
- Shielded for EMI/RFI protection

### MATING CONNECTORS:

Adam Tech USB and IEEE 1394 series connectors and all industry standard USB and IEEE 1394 connectors.

### SPECIFICATIONS:

#### Material:

- Standard insulator: PBT, Glass filled, rated UL94V-0
- Optional Hi-Temp insulator: Nylon PA9T, rated UL94V-0
- Insulator Color: Black (White optional)
- Contacts: Phosphor Bronze or Brass
- Shell: Steel, nickel plated

#### Contact Plating:

- Gold Flash over Nickel on mating area, Tin over Copper underplate on tails

#### Electrical:

- Operating Voltage: 30V AC
- Current Rating: 1 Amp max.
- Contact Resistance: 30 mΩ max.
- Insulation Resistance: 1000 MΩ min.
- Dielectric Withstanding Voltage: 100V AC for 1 minute

#### Mechanical:

- Insertion force: 3 oz max.
- Withdrawal force: 0.5 oz min.

#### Temperature Ratings:

- Operating Temperature: PBT: -40°C to +85°C
- Nylon PA9T: -55°C to +105°C
- Soldering process temperature:
  - Standard insulator: 235°C
  - Hi-Temp insulator: 260°C

### PACKAGING:

Anti-ESD plastic trays or tubes

### APPROVALS AND CERTIFICATIONS:

- UL Recognized File No. E224053
- CSA Certified File No. LR1578596



www.usb.org



### ORDERING INFORMATION

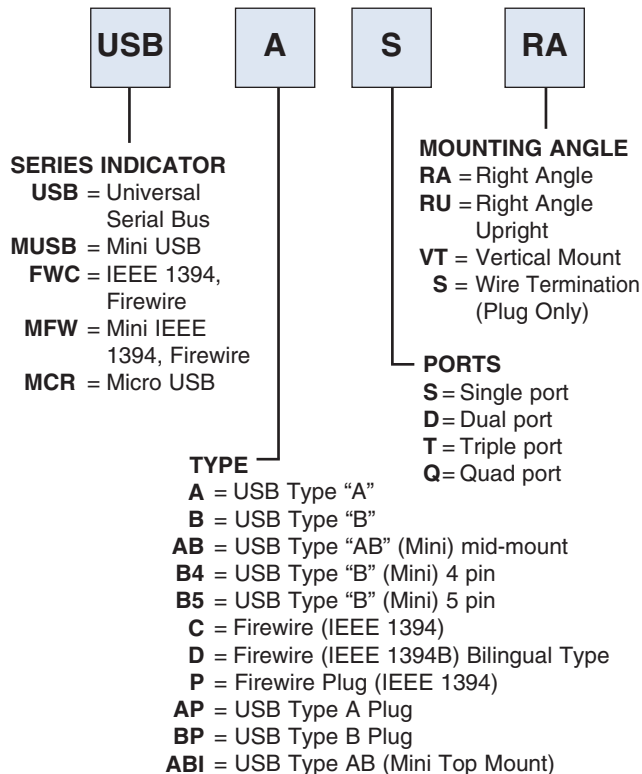

### OPTIONS:

- Add as Suffix to basic part no.
- SMT** = Surface Mount Leads with Hi-Temp insulator for Hi-Temp soldering processes up to 260°C
- 30** = 30 pin gold plating in contact area
- WT** = White color insulator
- HT** = Hi-Temp insulator for Hi-Temp soldering processes up to 260°C (Add this option for thru-hole products only. All SMT products are manufactured with Hi-Temp insulators)
- T/R** = Tape & Reel packaging

#### USB-A-S-RA

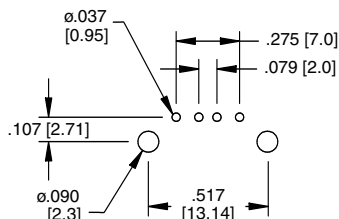
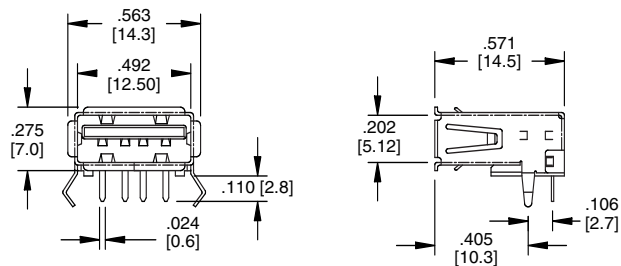

Recommended PCB Layout

#### USB-A-S-RA-SMT

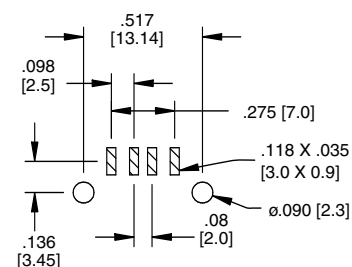
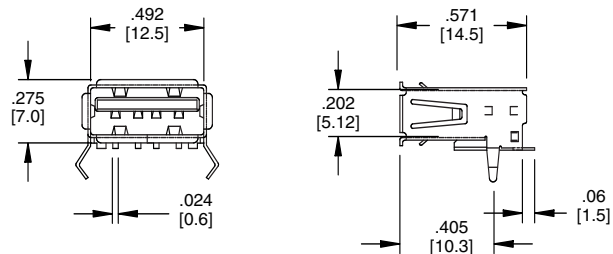

Recommended PCB Layout

#### USB-A-S-VT

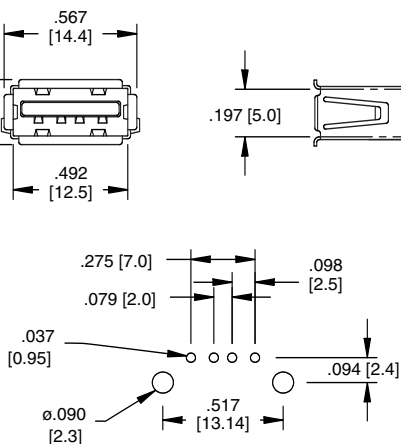
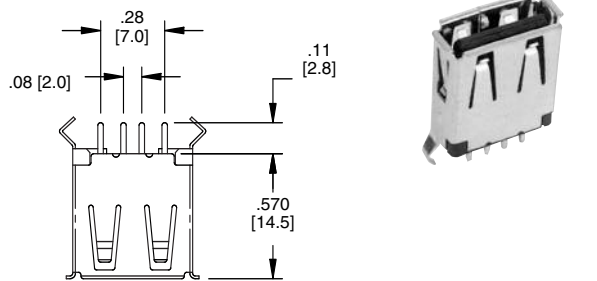

Recommended PCB Layout  
(Bottom View)

#### USB-A-S-RA-TSMT

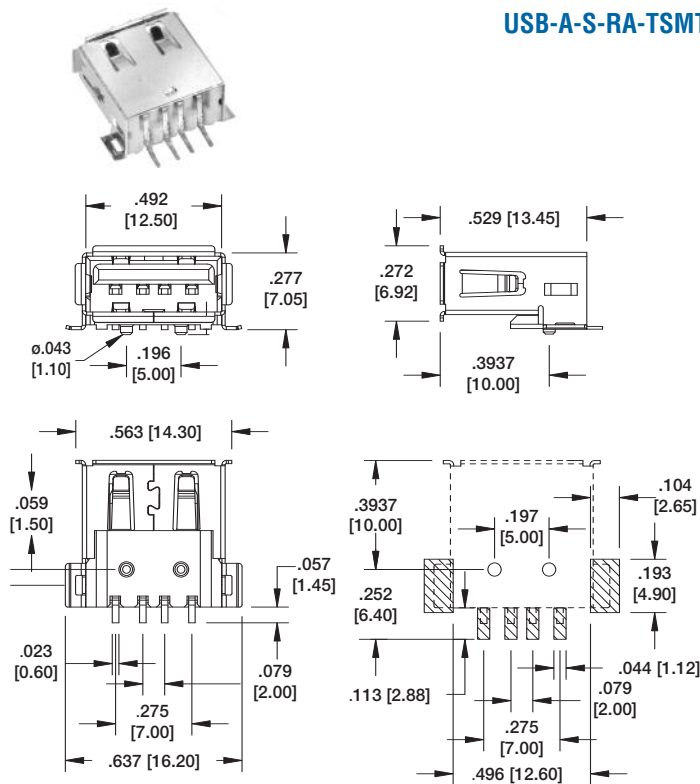

Recommended PCB Layout

#### USB-A-S-RU

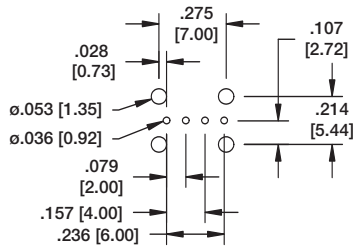
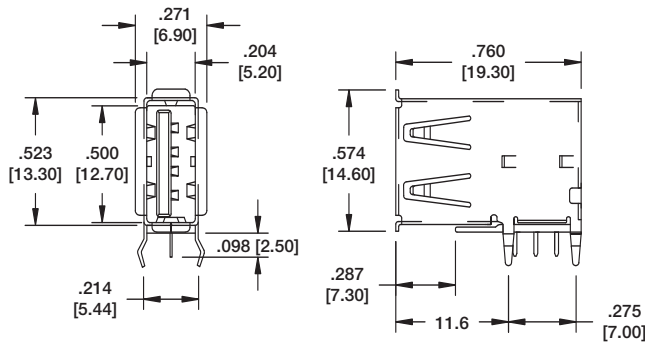

Recommended PCB Layout

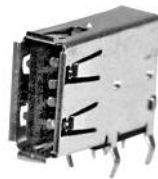

#### USB-A-S-RA-FS

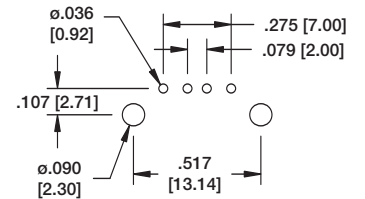
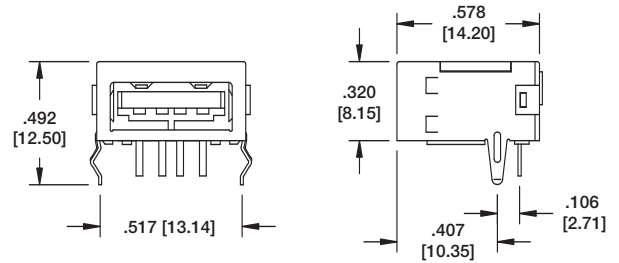

Recommended PCB Layout



#### USB-AP-S-RA

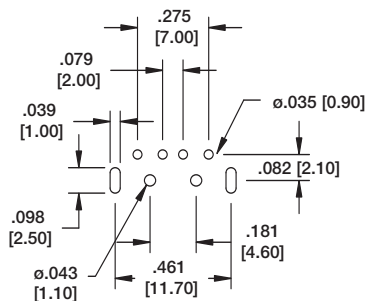
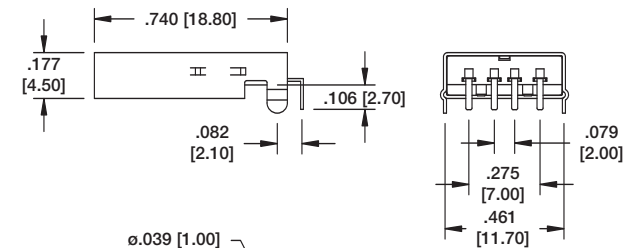

Recommended PCB Layout



#### USB-AP-S-RA-SMT

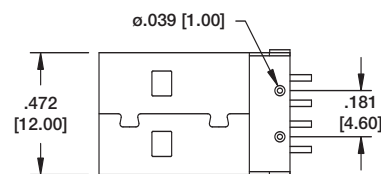
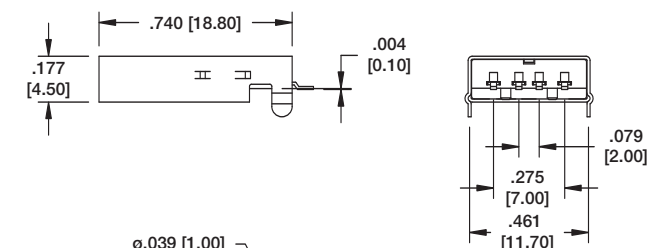

Recommended PCB Layout



#### USB-A-D-RA

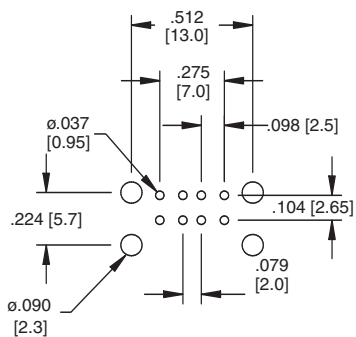

Recommended PCB Layout  
(Bottom View)

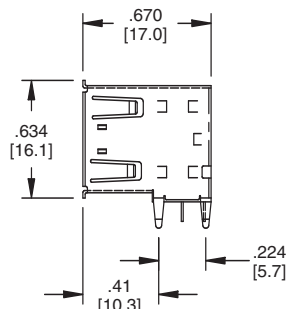
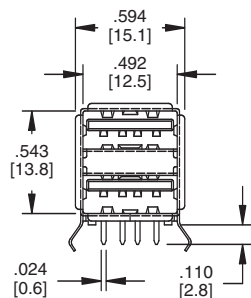

#### USB-A-Q-RA

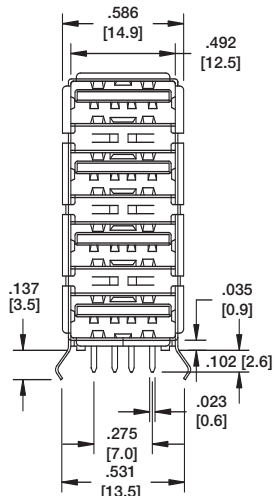
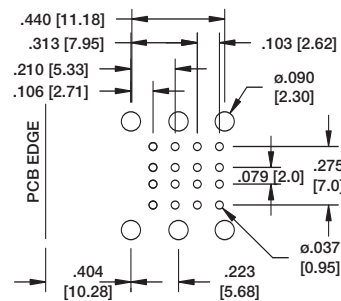

#### USB-A-T-RA

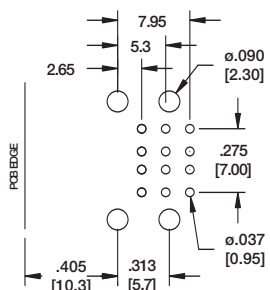

Recommended PCB Layout  
(Bottom View)

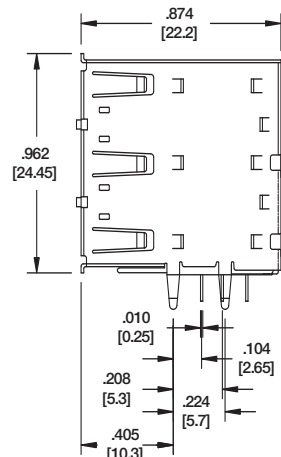
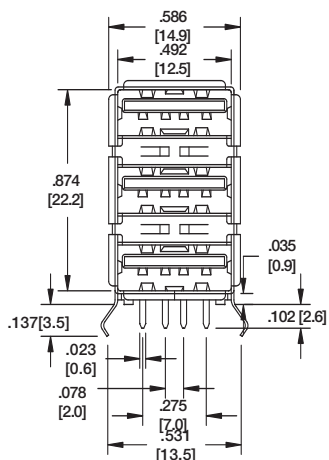

#### USB-A-D-VT

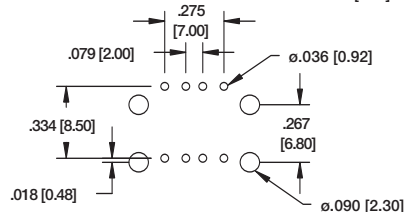
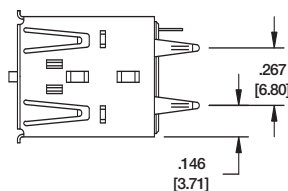
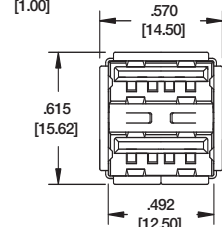
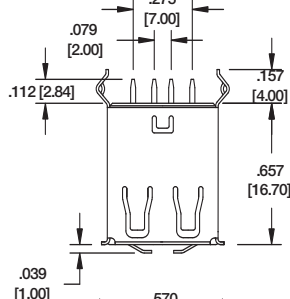

Recommended PCB Layout

#### USB-B-S-RA

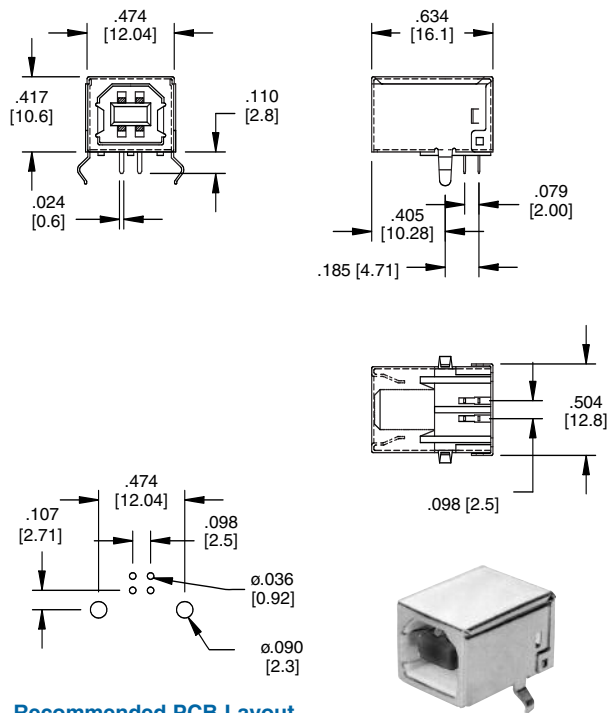

Recommended PCB Layout

#### USB-B-S-RA-TSMT

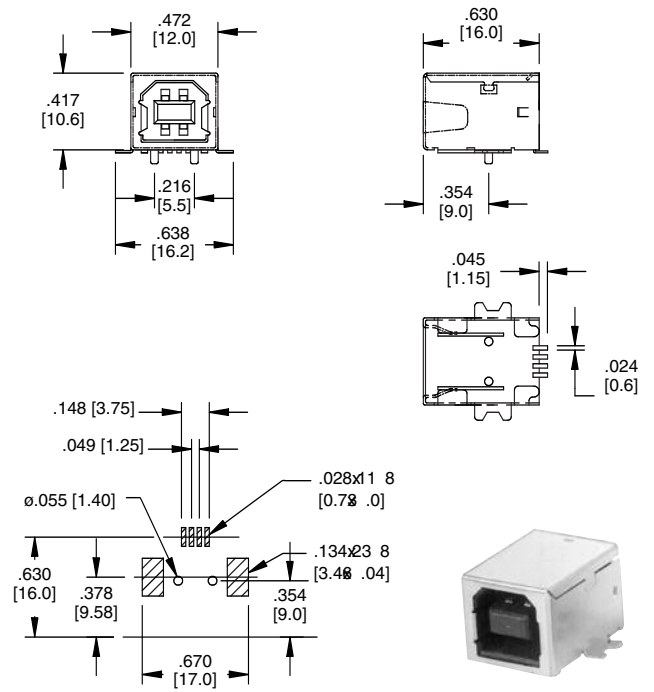

Recommended PCB Layout

#### USB-B-S-VT

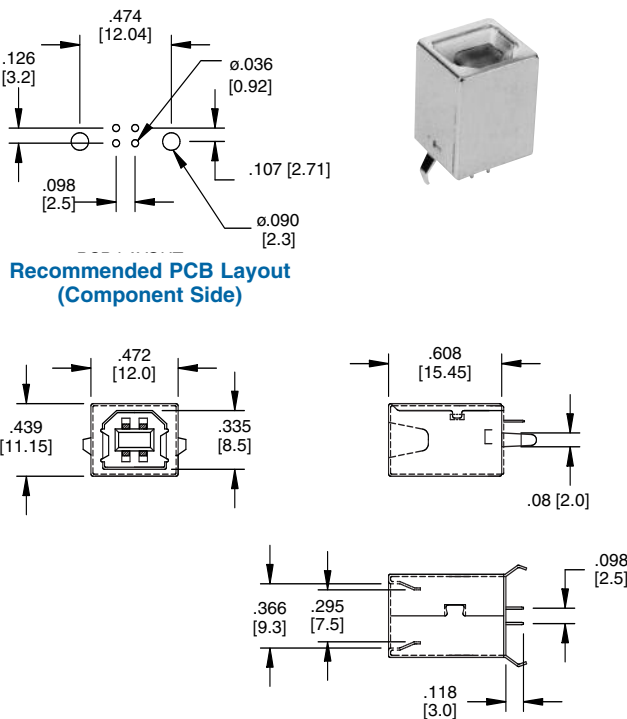

Recommended PCB Layout  
(Component Side)

#### USB-BP-S

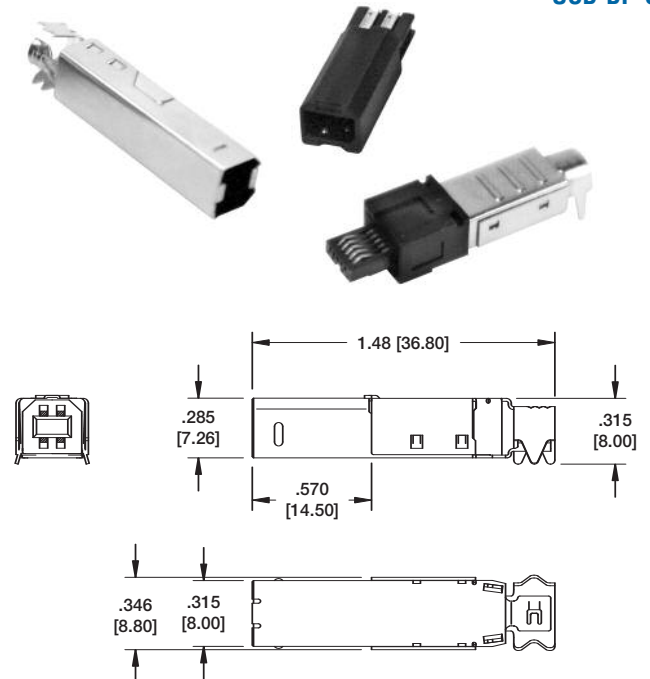

#### FWC-C-S-RA-SMT

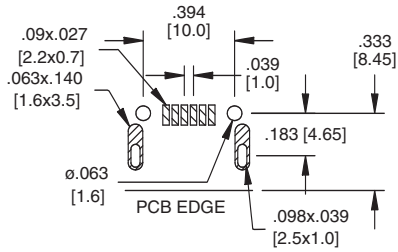

Recommended PCB Layout

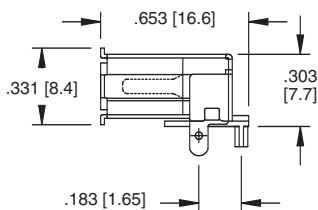
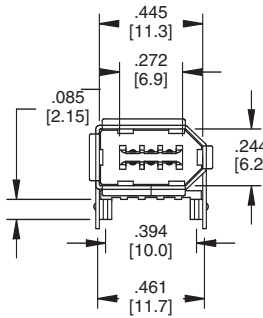
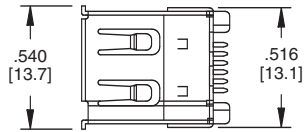

#### FWC-C-S-RU

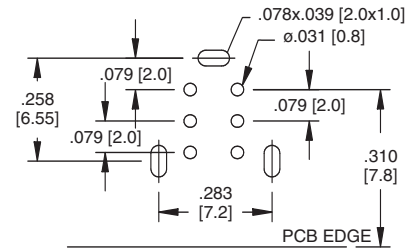
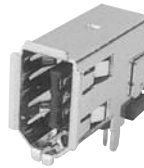

Recommended PCB Layout

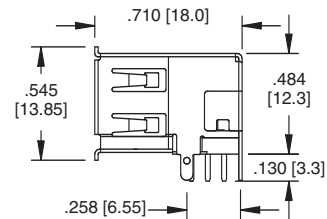
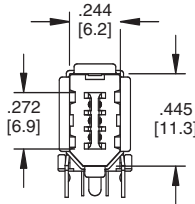
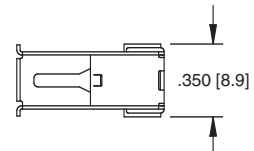

#### FWC-C-S-VT

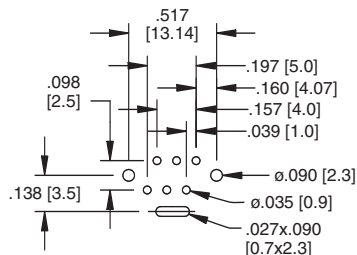

Recommended PCB Layout

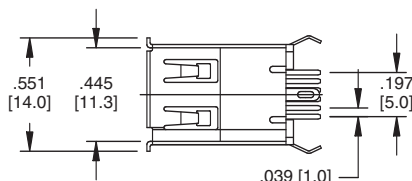
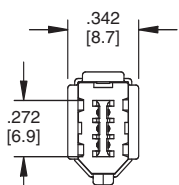
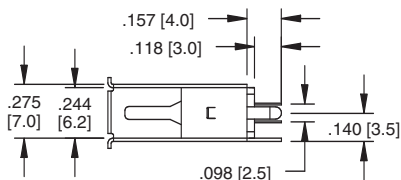

#### FWC-C-S-RA

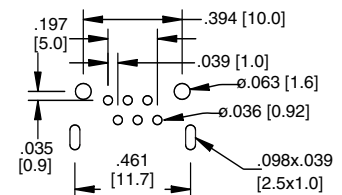
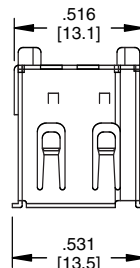

Recommended PCB Layout

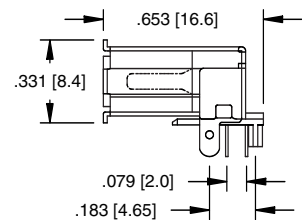
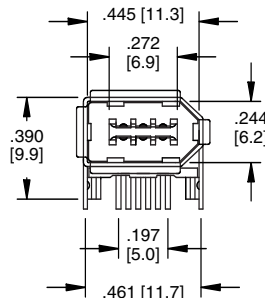

#### MUSB-A-S-RA-TSMT

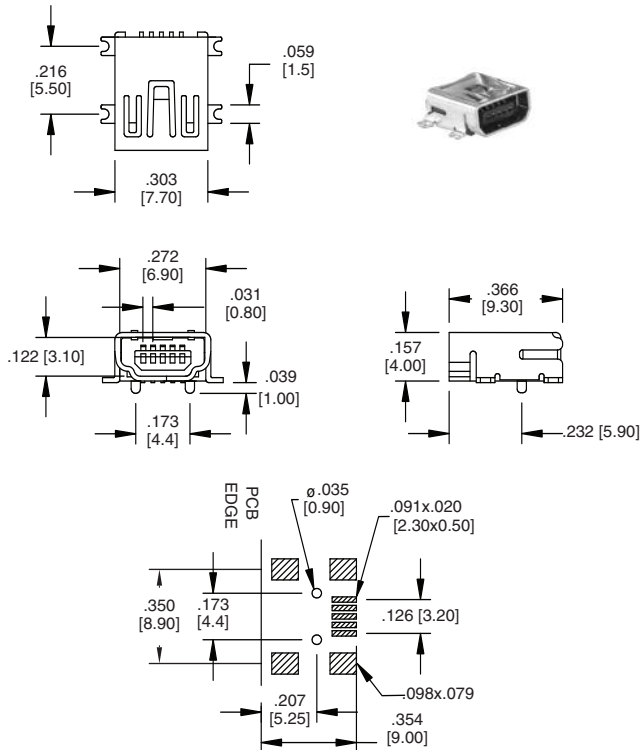

Recommended PCB Layout

#### MUSB-B4-S-RA-TSMT

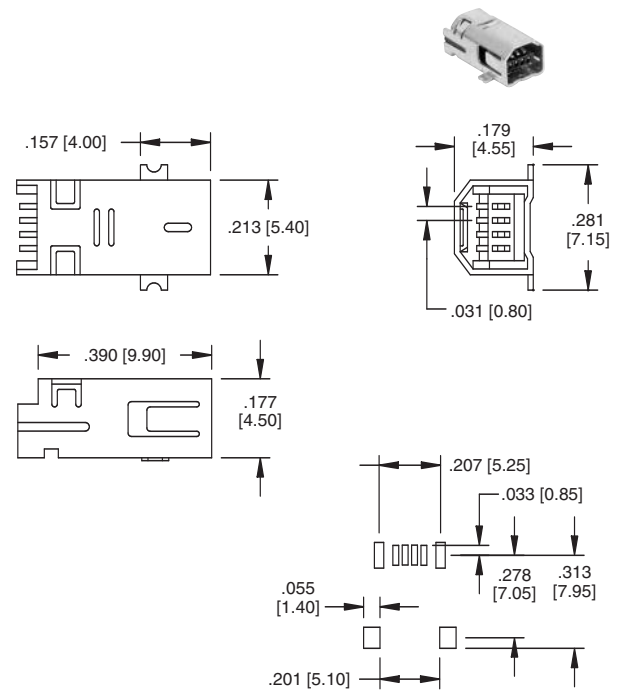

Recommended PCB Layout

#### MUSB-B5-S-RA-TSMT

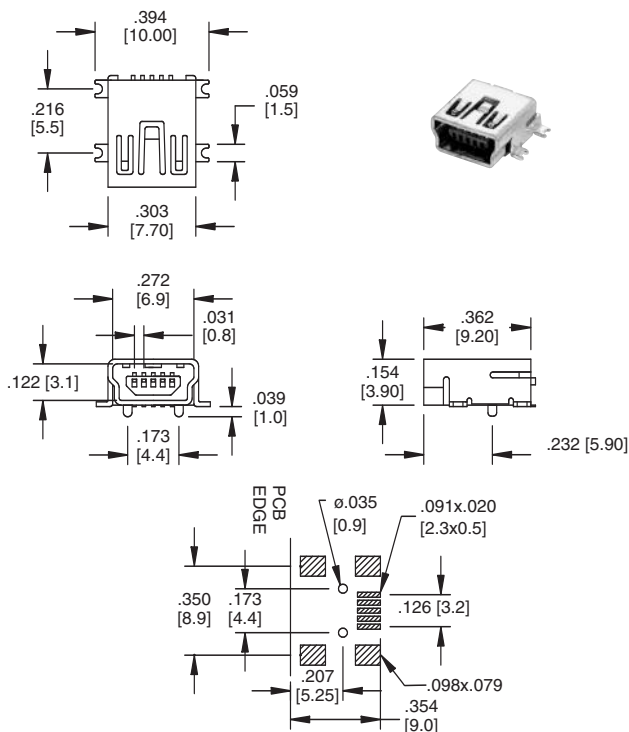

Recommended PCB Layout

#### MUSB-B5-S-RA

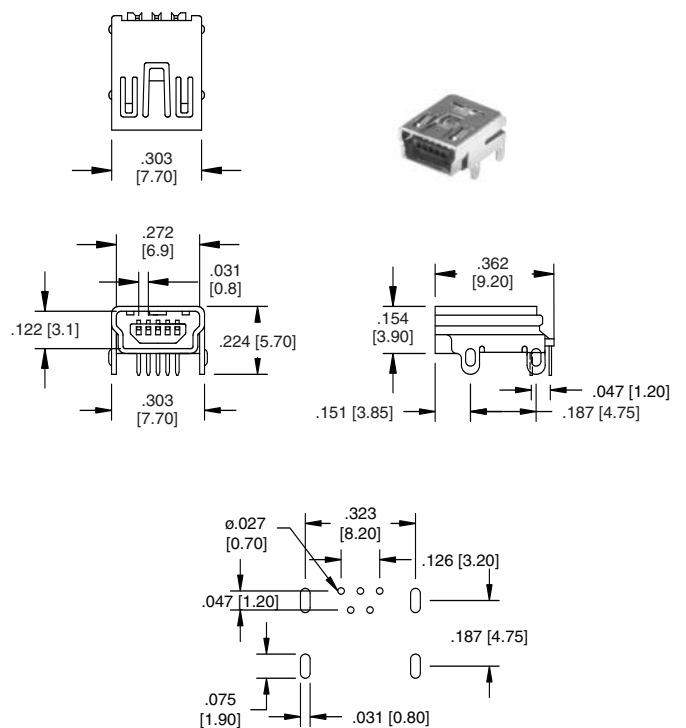

Recommended PCB Layout



#### MINI USB MUSB-AB-S-RA-TSMT

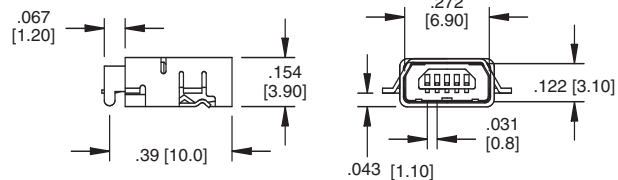
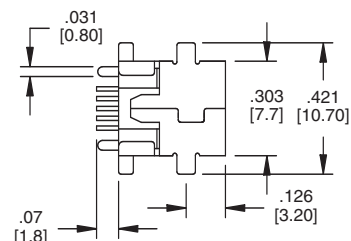
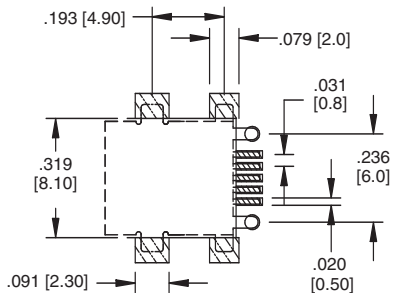

Recommended PCB Layout

#### MINI USB MUSB-AB1-S-RA-TSMT

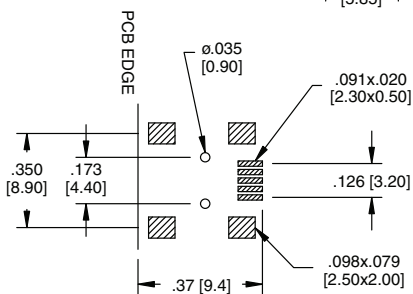
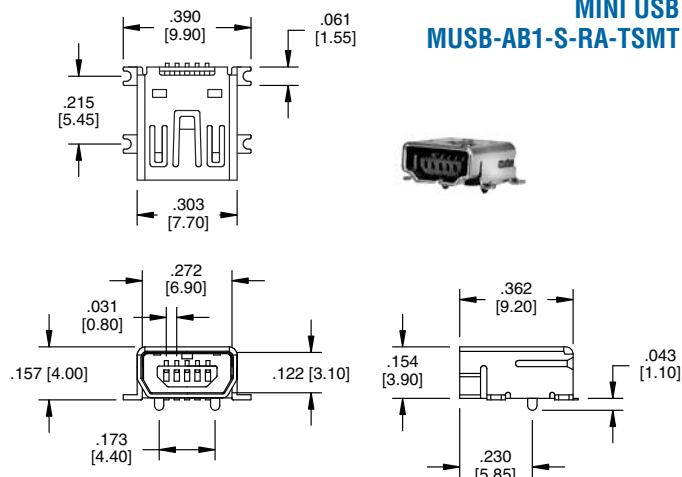

Recommended PCB Layout

#### MUSB-A4-S-RA-TSMT-XX

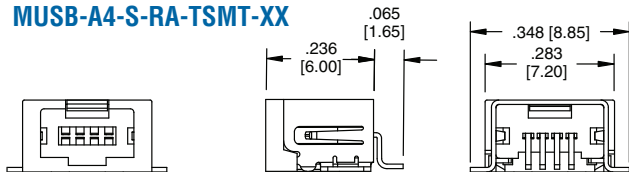

#### MUSB-A4-S-RA-TSMT-MK MIDDLE KEY

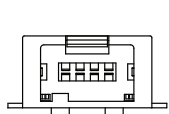

#### MUSB-A4-S-RA-TSMT-SK SINGLE KEY

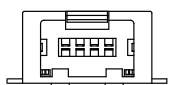
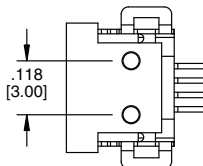

#### MUSB-A4-S-RA-TSMT-DK DUALE KEY

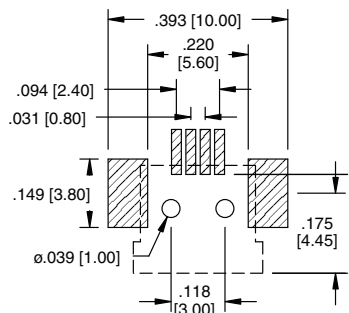

Recommended PCB Layout

#### MICRO USB MCR-AB-S-RA-TSMT

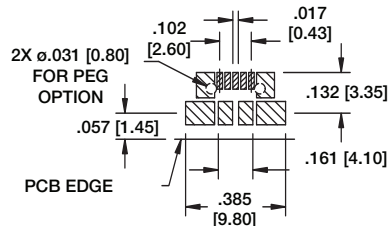
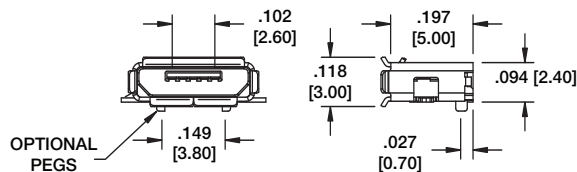
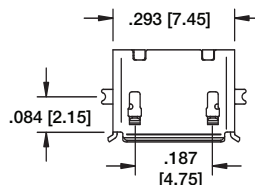
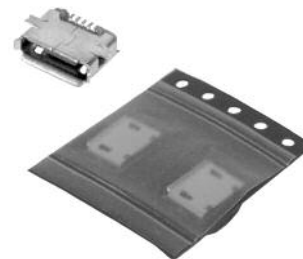

Recommended PCB Layout